

**PRODUCT SPECIFICATIONS**

Crosstown® 16 Gauge Stainless Steel 32-1/4" x 18-1/4" x 10" 30/70 Double Bowl Undermount Sink. Sink is handmade/fabricated from 16 gauge 304 Stainless Steel with a Polished Satin finish, Center drain placement, and Full spray sides and bottom with Sides and Bottom pads.

<b>Installation Type:</b>	Undermount
<b>Material:</b>	304 Stainless Steel
<b>Finish:</b>	Polished Satin
<b>Gauge:</b>	16
<b>Sound Deadening:</b>	Full spray sides and bottom with Sides and Bottom pads
<b>Number of Bowls:</b>	2
<b>Sink Dimensions:</b>	32-1/4" x 18-1/4" x 10"
<b>Bowl 1 Dimensions:</b>	7-1/2" x 15-3/4" x 6"
<b>Bowl 2 Dimensions:</b>	21" x 15-3/4" x 10"
<b>Drain Size:</b>	3-1/2" (89mm)
<b>Drain Location:</b>	Center
<b>Minimum Cabinet Size:</b>	36"
<b>Mounting Hardware:</b>	Part # 54300008 included
<b>Template Included:</b>	Yes
<b>Cutout Template #:</b>	<a href="#">1000001305</a>

Template is available for download at [elkay.com](#). CAD software will be required to open the template.

**Special Note:** Reversible design, sink can be rotated so small bowl is on the left or right. Reserve Selection products are sold exclusively, in-store and online, through authorized wholesalers.

**Installation Profile:**

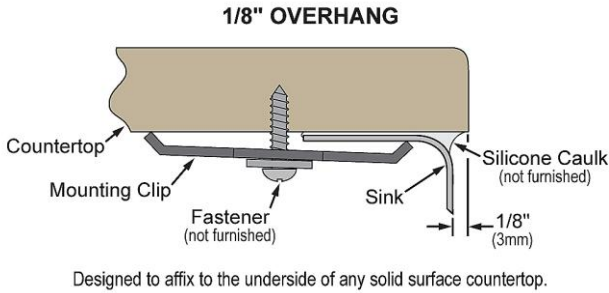

A Century of Tradition and Quality. For more than 100 years, Elkay has been making innovative products and providing exceptional customer care. We take pride in offering plumbing products that make life easier, inspire change and leave the world a better place.



**Product Compliance:** ASME A112.19.3/CSA B45.4







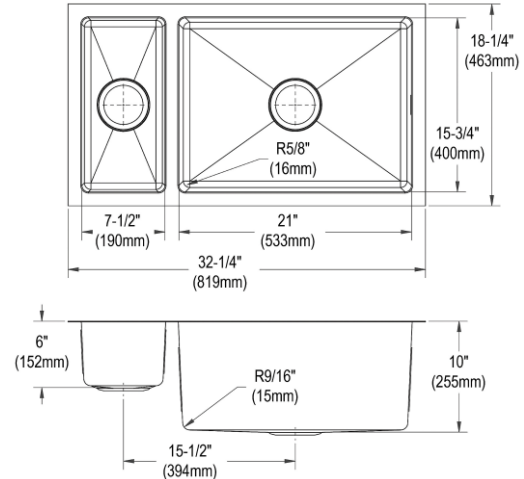

Sinks are listed by IAPMO® as meeting the applicable requirements of the Uniform Plumbing Code®, International Plumbing Code®, and National Plumbing Code of Canada.

- [Clean and Care Manual \(PDF\)](#)
- [Installation Instructions \(PDF\) - 1000005239](#)
- [Warranty \(PDF\)](#)



PART: \_\_\_\_\_ QTY: \_\_\_\_\_  
 PROJECT: \_\_\_\_\_  
 CONTACT: \_\_\_\_\_  
 DATE: \_\_\_\_\_  
 NOTES: \_\_\_\_\_  
 APPROVAL: \_\_\_\_\_

In keeping with our policy of continuing product improvement, Elkay reserves the right to change product specifications without notice. Please visit [elkay.com](#) for the most current version of Elkay product specification sheets. This specification describes an Elkay product with design, quality, and functional benefits to the user. When making a comparison of other producers' offerings, be certain these features are not overlooked. Latest version of the spec sheet available: [https://www.elkayfiles.com/spec-sheets/EFRU321910T\\_spec.pdf](https://www.elkayfiles.com/spec-sheets/EFRU321910T_spec.pdf)

Optional Accessories		
<a href="#">CTXBG1914</a>	Crosstown® Stainless Steel 19-3/8" x 14-1/8" x 1-1/4" Bottom Grid w/Center Drain <a href="#">Spec Sheet (PDF)</a>	
<a href="#">CTXBG614</a>	Crosstown® Stainless Steel 6-1/4" x 14-1/2" x 1-1/4" Bottom Grid <a href="#">Spec Sheet (PDF)</a>	
<a href="#">LK35</a>	3-1/2" Drain Fitting Type 304 Stainless Steel Body Strainer Basket with 316 Stainless Steel Tailpiece <a href="#">Spec Sheet (PDF)</a>	
<a href="#">LKDD</a>	3-1/2" Drain Fitting Deep Strainer Basket <a href="#">Spec Sheet (PDF)</a>	
<a href="#">LKAV1031</a>	Elkay Avado Single Hole Kitchen Faucet with Pull-down Spray and Forward Only Lever Handle <a href="#">Spec Sheet (PDF)</a>	
<a href="#">LKAV2031</a>	Avado® Single Hole Kitchen Faucet with Semi-professional Spout and Forward Only Lever Handle <a href="#">Spec Sheet (PDF)</a>	

*In keeping with our policy of continuing product improvement, Elkay reserves the right to change product specifications without notice. Please visit [elkay.com](http://elkay.com) for the most current version of Elkay product specification sheets. This specification describes an Elkay product with design, quality, and functional benefits to the user. When making a comparison of other producers' offerings, be certain these features are not overlooked. Latest version of the spec sheet available: [https://www.elkayfiles.com/spec-sheets/EFRU321910T\\_spec.pdf](https://www.elkayfiles.com/spec-sheets/EFRU321910T_spec.pdf)*