

NANLITE

PavoTube II 6X/6XR

USER MANUAL

Version: V1.0
2025-02-27

Revision History

Version	Date (Y-M-D)	Note
V1.0	2025-02-27	First Release

Contents

1. Introduction	1
2. Product Overview	2
2.1. Product Layout	2
2.2. Specifications	3
2.3. Includes	4
3. Safety Instructions	5
4. Installing Instructions	7
4.1. Position	7
4.2. Installing via 1/4"-20 Mount	7
4.3. Installing via T12 Clip	8
4.4. Installing the Iron Plate	8
4.5. Installing the Eggcrate	9
4.6. Using the Waterproof Bag	9
5. Operating Instructions	10
5.1. Lighting Mode Control	10
5.1.1. Control Panel Control	10
5.1.2. DMX Control	11
5.1.3. NANLINK APP Control-via Bluetooth	13
5.1.4. CRMX Control	14
5.2. Menu	14
5.2.1. Menu Overview	14
5.2.2. Menu Operation	15
5.2.3. Others	16
5.3. Charging Instructions	16
5.4. NFC Function	16
6. Troubleshooting for Common Issues	17

1. Introduction

Thank you for purchasing the Nanlite product – PavoTube II 6X/XR.

The PavoTube II 6X and 6XR are portable RGBWW full-color pixel tube lights, perfect for a wide range of scenarios. With a compact design, they are easy to carry and quick to set up. Featuring an ultra-wide CCT range of 2700K-12000K, 36,000 colors, and 15 built-in effects, these lights cater to diverse ambiance needs and emotional expressions. They can be powered by the built-in lithium battery, an adapter, or a power bank, ensuring continuous and stable operation during your shoots. Control options include on-board, the Nanlink App, and DMX/RDM, along with support for various accessories, offering enhanced flexibility and creative freedom.

The PavoTube II 6X and 6XR will bring exceptional convenience to your photography and inspire boundless creativity. Before using these products, please read this manual carefully to ensure you can fully utilize all the features. We look forward to seeing how these tools help you achieve even more impressive results.

2. Product Overview

2.1. Product Layout

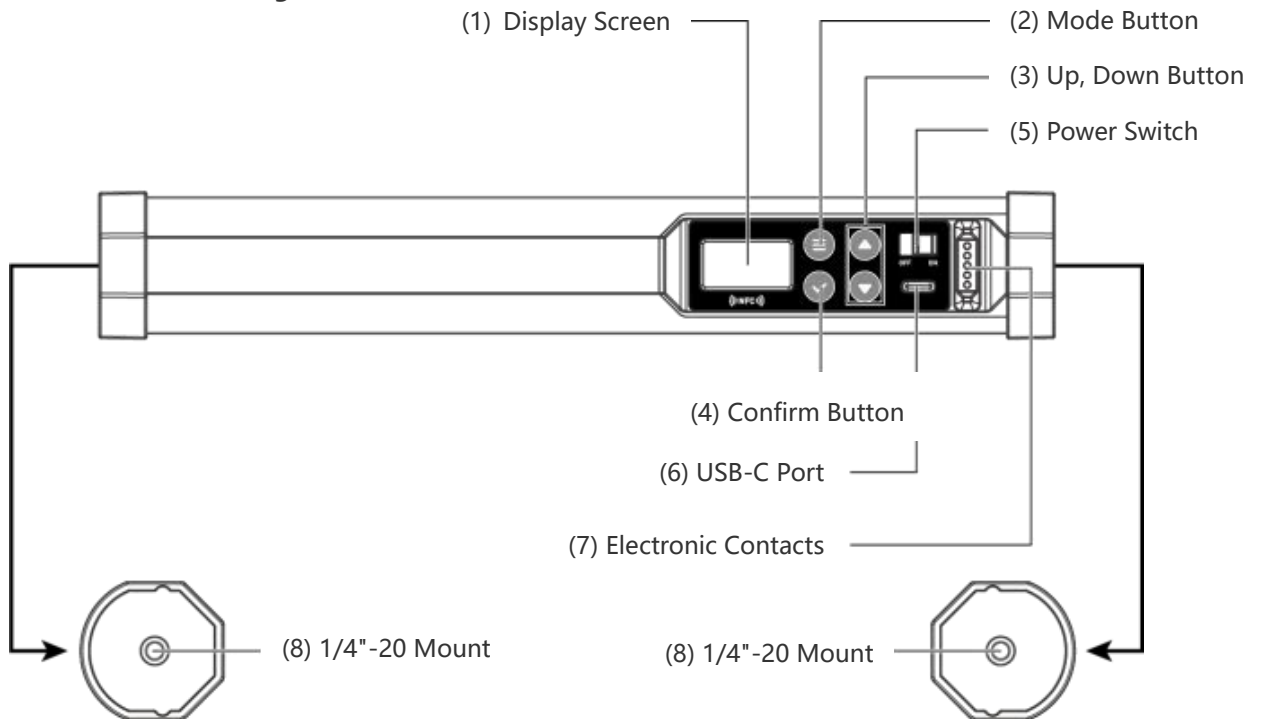

(1) Display Screen: For displaying the settings.

(2) Mode Button: For switching to the Mode interface or return to the previous menu.

(3) Up, Down Button: For adjusting options or values. These buttons support both short and long presses.

(4) Confirm Button: For selecting option, deselecting option, and entering the next menu.

(5) Power Switch: For turning on/off the fixture.

(6) USB-C Port: For connecting power, firmware updates, and as a DMX port for connecting the DMX cable.

(7) Electronic Contacts: For charging the fixture in the PavoTube II 6X/6XR 8-light kit case.





(8) 1/4"-20 Mount: For mounting the fixture on a light stand with a 1/4"-20 stud, on a tripod head, or on a ball head.

2.2. Specifications



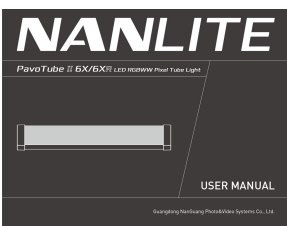

Model Name	PavoTube II 6X/6XR
Rated Power	16W
Input Voltage/Current	DC: 5V/2A, 5V/3A, 9V/2A, 9V/3A, 12V/2A, 12V/3A, 20V/1A PD3.0 adapter PD3.0: 20W Min
LED Type	RGBWW
CCT	2700K→12000K (GM±150)
CRI	Average 96
TLCI	Average 97
TM-30 Rf	Average 93
TM-30 Rg	Average 100
SSI (3200K)	83
SSI (5600K)	73
Dimming	0%→100%, by 1% increment
Control	On-board, NANLINK APP, DMX/RDM, *CRMX (*PavoTube II 6XR only)
Special Effects	Hue Loop, CCT Loop, Int Loop, Flash, Pulse, Storm, Police Car, TV, Paparazzi, Candle/Fire, Disco, Bad Bulb, Firework, Explosion and Welding
Pixel Effects	Hue Loop, CCT Loop, Int Loop, Multicolor, Fade, Scroll, Rainbow, *Process, *Fire, *Driving (*on-board control is not available)

2.3. Includes

PavoTube II 6X

PavoTube II 6X×1	Iron Plate×3	USB-C Cable×1
		
Carrying Bag×1	User Manual×1	/
		/

PavoTube II 6XR

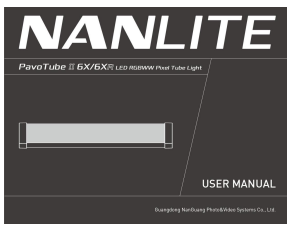
PavoTube II 6XR×1	Iron Plate×3	USB-C Cable×1
		
Carrying Bag×1	User Manual×1	/
		/

3. Safety Instructions

Please read and understand all safety instructions before installing or operating the fixture. Always follow the instructions to avoid personal injury and fixture damage. Retain all safety and operating instructions for future reference.

Electrical:

 **Danger**

Please disconnect the power before moving or transporting the fixture.

 **Caution**

Please use proper and undamaged USB-C cable to connect the fixture correctly, avoiding the risk of electric shock or fixture damage.

Installation:

 **Danger**

Please carefully read the manual and follow the instructions to install the fixture to avoid any unnecessary incidents.

Operation:

 **Danger**

Please do not use the fixture near flammable or explosive materials.

 **Danger**

Please be cautious, as the flashing effect may trigger seizures.

 **Danger**

Please keep the fixture away from corrosive liquids or high-pressure steam.

 **Caution**

Please ensure the fixture is used in an environment between -20°C and 45°C; operating outside this temperature range may damage the fixture.

Caution

Please install the fixture in a dry, well-ventilated area, and avoid using it in damp or dusty environments. For use in damp environments, please place the fixture in a waterproof bag prior to use.

Caution

Please do not look directly at the light source without wearing protective glasses, as this may cause irreversible eye injury.

Caution

Please remind the crew to avoid eye injury caused by accidentally looking directly at the light source before the fixture lights up.

Maintenance:

Danger

Please do not disassemble or repair any part of the fixture on your own, as this will void the warranty. Maintenance and repair work should be carried out by an authorized service center and professional personnel.

Danger

Please disconnect the power before starting any maintenance work.

Caution

Please ensure that the fixture is completely dry before transportation or storage after using it in a humid environment.

Notice

Please ensure the fixture is stored away from the following environments or items: extreme temperatures, direct sunlight, high humidity, intense vibrations, dust, strong magnetic fields, and flammable or explosive materials.

Notice

Please transport the fixture and accessories in suitable case to avoid damage.

4. Installing Instructions

4.1. Position

Place the fixture directly on a flat surface.

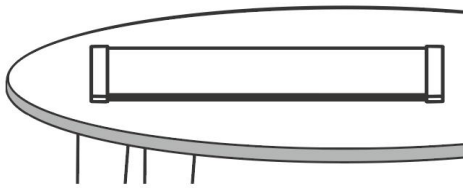

Horizontal Position

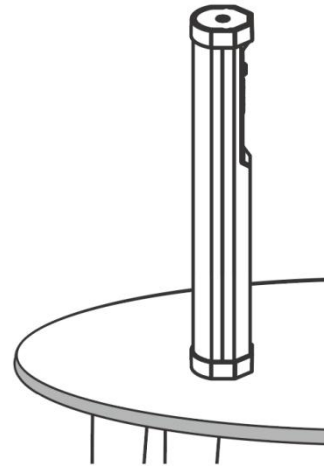

Vertical Position

4.2. Installing via 1/4"-20 Mount

The fixture can be installed on a handle tripod via the 1/4"-20 mount, on a light stand with a 1/4"-20 stud, or mounted on a light stand via a ball head (sold separately) or other accessories, for various mounting options.

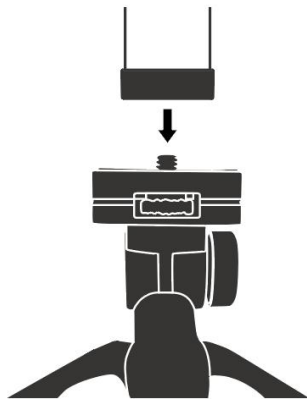

Handle Tripod



Light Stand with 1/4"-20 Stud

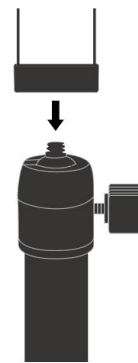

Ball Head

4.3. Installing via T12 Clip

The fixture can be held via a T12 clip (sold separately), and the clip can be attached to a light stand via the 1/4"-20 mount.

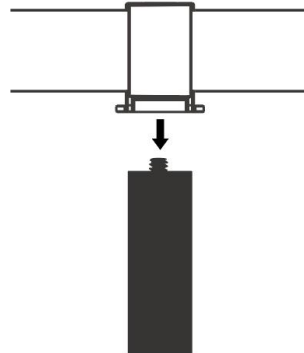

Installing via T12 Clip

4.4. Installing the Iron Plate

The fixture is equipped with powerful magnets at both ends, allowing it to be directly attached to ferrous surfaces, or with the included iron plates, attached to non-ferrous surfaces.



Ferrous surface

Attach the fixture directly

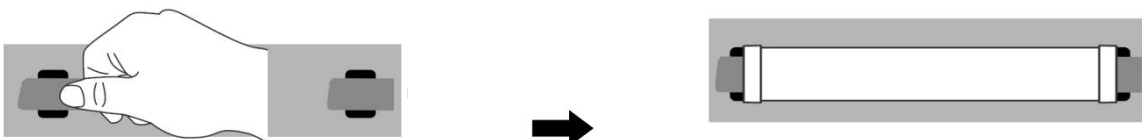

Attach the iron plates on the non-ferrous surface via gaffer tape

Attach the fixture on iron plates

4.5. Installing the Eggcrate

Attach the eggcrate (sold separately) on the fixture via the elastic strap.

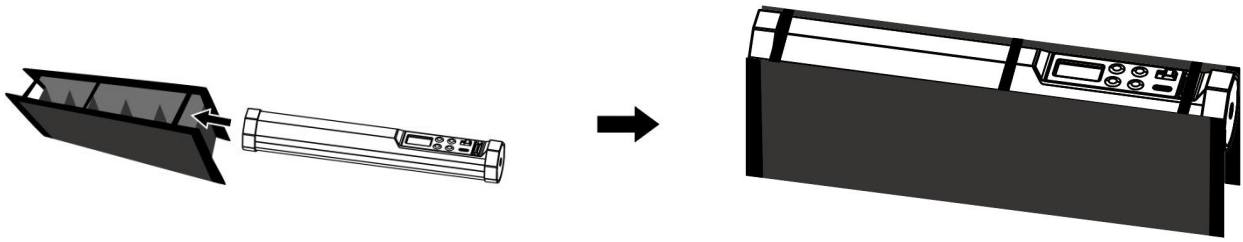

4.6. Using the Waterproof Bag

Place the fixture into the waterproof bag (sold separately) to enable the fixture to work in the rain or underwater.

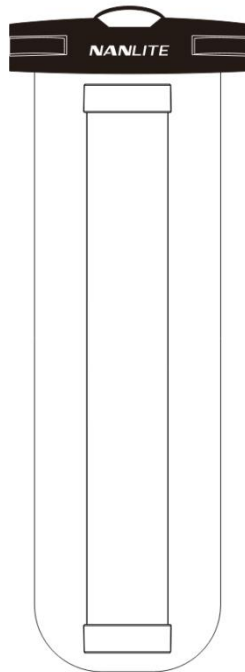

5. Operating Instructions

Toggle the power switch, and the screen will display the NANLITE logo, indicating that the fixture has been turned on.

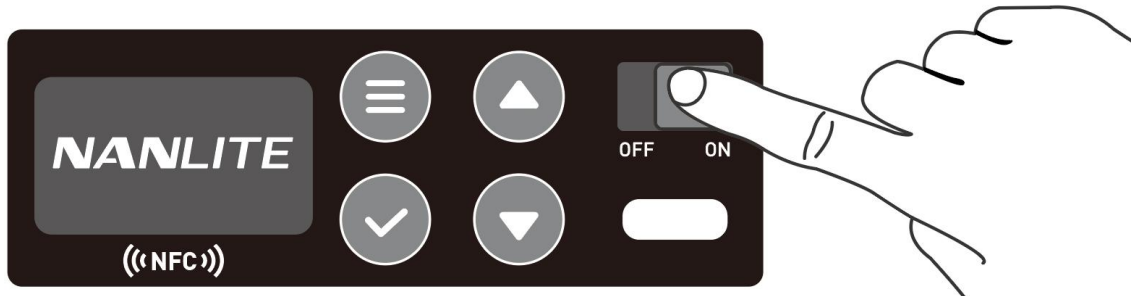

The control panel includes **Mode**, **Confirm**, **Up**, and **Down** buttons.



5.1. Lighting Mode Control

This fixture has CCT, HSI, Gel, Effect, and Pixel Effect modes.

5.1.1. Control Panel Control

(1) Mode Selection

Press the **Mode** button to enter the mode selection interface, where the currently selected mode will be highlighted. Press the **Up** or **Down** buttons to toggle between options, and press the **Confirm** button to enter the corresponding mode.

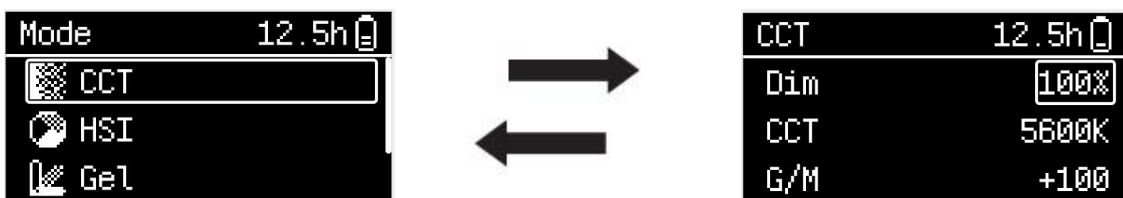

▲ Note: In the mode interface, press the **Mode** button to return to the mode selection interface.

(2) Mode Operation

In the mode operation interface, press the **Up** or **Down** buttons to select a parameter. Press the **Confirm** button to confirm the selection (highlighted indicates selected). Press the **Up** or **Down** buttons to adjust the parameter, and press the **Confirm** button again to deselect and complete the setting.

CCT	12.5h	CCT	12.5h
Dim	100%	Dim	100%
CCT	5600K	CCT	5600K
G/M	+100	G/M	+100

5.1.2. DMX Control

(1) DMX Connection

① Connect the fixture to the DMX console via a DMX cable

The fixture needs a USB-C to DMX cable splitter (CB-DMX-USBC-1/3 II), compatible with a 5-pin socket. A 5-pin shielded cable with a diameter of no less than 0.3mm must be used to connect the light fixture to the DMX console. The fixture is built with a 5-pin XLR socket. If the DMX console is built with a 3-pin XLR socket, an adapter will be required.

② DMX Termination Resistor

When connecting fixtures with DMX cables, the DMX out port of the last fixture in the daisy chain must be connected to a DMX termination resistor (not included). This effectively prevents interference during DMX signal transmission.

(2) DMX Settings

The DMX settings include Address, DMX Mode, DMX Pixel, Reduce Channels, Smoothing, Dim Curve and Loss Behavior.

Address/DMX	12.5h
Address	001
DMX Mode	CCT 8bit
DMX Pixel	1

① Address Setting

Select the Address in the menu, press the **Confirm button**, press the **Up** or **Down buttons** to adjust the parameters:
Address/DMX → Address.

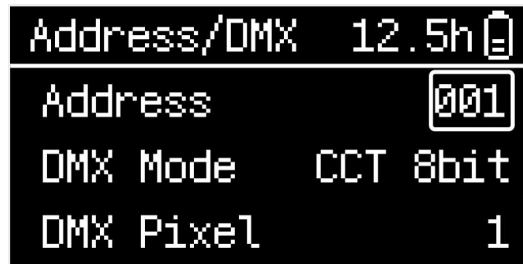

② DMX Mode Setting

Enter the DMX Mode interface: Address/DMX → DMX Mode.

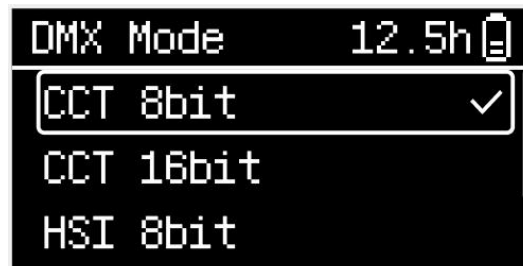

③ Other DMX Settings

The operation methods for Reduce Channels, Smoothing, Dim Curve and Loss Behavior are as below:

A. Reduce Channels and Smoothing operation:

Press the **Up** or **Down buttons** to toggle between DMX settings options, and press the **Confirm button** to select an option. Then press the **Up** or **Down buttons** to adjust the parameters. Press the **Confirm button** again to deselect the option.

B. Dim Curve and Loss Behavior operation:

Press the **Up** or **Down buttons** to toggle between DMX settings options, and press the **Confirm button** to enter the next level menu. Press the **Up** or **Down buttons** to select the parameter, and press the **Confirm button** to confirm the setting.

After the DMX settings are finished, and the DMX cable is connected, for detailed operations on controlling the fixture with a DMX console, please refer to the DMX Charts.

(3) RDM Function

- ① Connect the fixture to a console with RDM function using a connection cable.
- ② Control the fixture using a console with RDM function (For detailed operations, please refer to the console manual).

▲ Note: The UID format of fixture is as below.

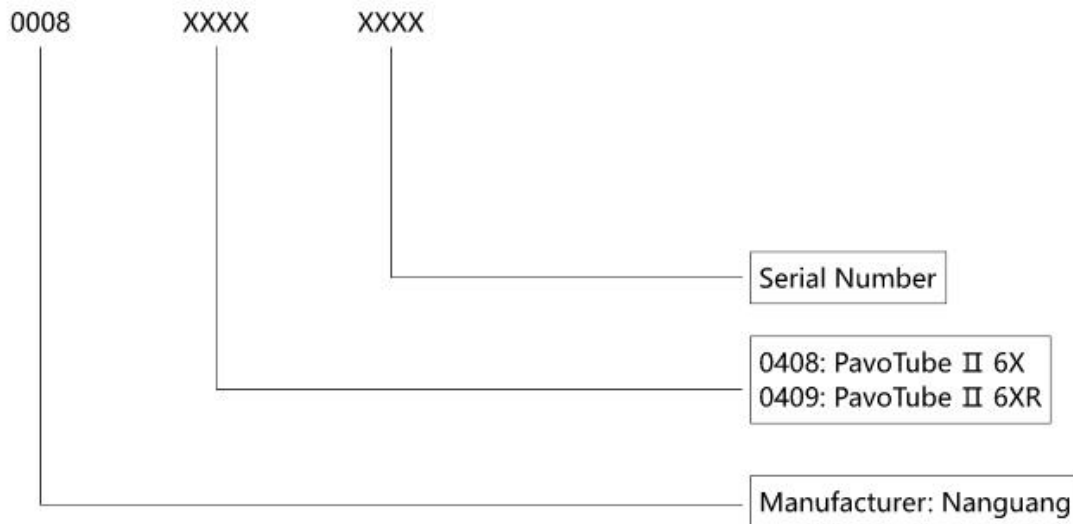

5.1.3. NANLINK APP Control-via Bluetooth

Enter the Bluetooth settings interface: Wireless Control → Bluetooth.

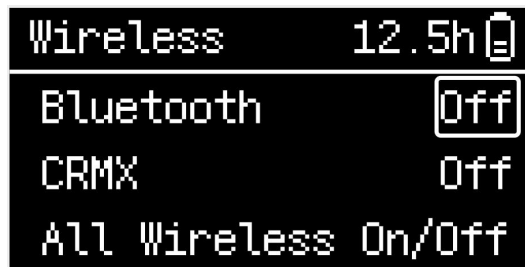

When Bluetooth is turned on, the Reset Bluetooth option appears on the interface, making it possible to reset Bluetooth.



5.1.4. CRMX Control

Enter the CRMX settings interface: Wireless Control → CRMX.

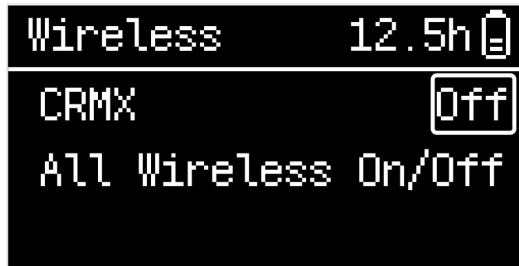

The CRMX wireless signal can be received when the CRMX is turned on.

The CRMX wireless signal can't be received when the CRMX is turned off.

Disconnect the fixture that needs to receive CRMX wireless signals.

▲ Note: The CRMX settings should be set to Unlink to allow the fixture to be reconnected to a new fixture or transmitter.

The Unlink CRMX option will be in the interface when the CRMX is on.

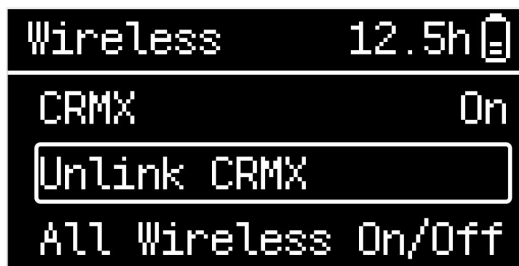

Use a CRMX transmitter to connect this fixture.

5.2. Menu

5.2.1. Menu Overview

In the menu, there are options including Address/DMX, Wireless Control, Fixture Settings and Language.



Level 1	Level 2
Address/DMX	Address
	DMX Mode
	DMX Pixel
	Reduce Channels
	Smoothing
	Dim Curve
	Loss Behavior
Wireless Control	Bluetooth
	Reset Bluetooth
	CRMX
	Unlink CRMX
	All Wireless On/Off
Fixture Setting	Firmware Update
	Reset All Settings
	Fixture Info
Language	/

5.2.2. Menu Operation

In the menu selection interface, press the **Up** or **Down** buttons to select an option, and press the **Confirm** button to enter the settings interface. Press the **Up** or **Down** buttons to select the parameter to be set, and press the **Confirm** button to select the parameter (highlighted indicates selected). Press the **Up** or **Down** buttons to adjust the parameter, and press the **Confirm** button again to deselect and complete the setting.

If selecting a parameter and pressing the **Confirm** button leads to a submenu or popup, select the option to be set and press the **Confirm** button to complete the setting and return to the previous menu.

In level 2 or level 3 menus, press the **Mode** button to return to the previous menu.

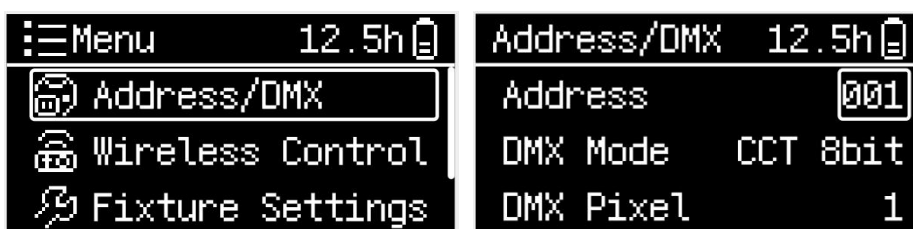

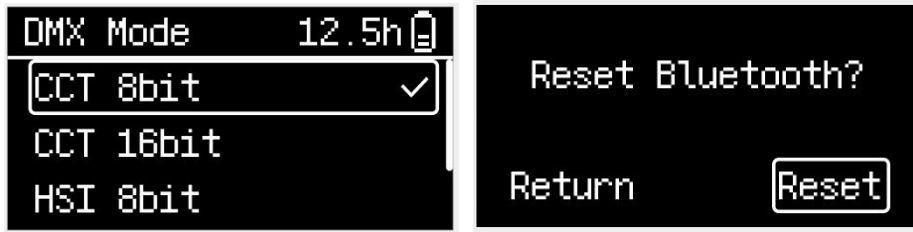

5.2.3. Others

(1) Firmware Update

Put the firmware files into the root directory of the USB drive (ensure the versions of the firmware files are the same), and insert the USB drive to the USB-C port, enter the Menu → Fixture Settings → Firmware Update, the system will automatically search for the firmware files.

- ▲ Note:
- ① Please do not rename the firmware files.
 - ② Ensure the USB drive is formatted to FAT, FAT32 or exFAT.
 - ③ If the instruction "No firmware found, press MODE to return" is displayed, please check whether the firmware files are correct, whether they are stored in the root directory of the USB drive, and whether the USB drive is formatted as FAT, FAT32 or exFAT.
 - ④ If all the above steps have been completed and the firmware files still cannot be found, please format the USB drive again.
 - ⑤ If the fixture still cannot recognize the USB drive, please replace the USB drive.

5.3. Charging Instructions

- (1) The fixture has a built-in lithium battery and can be used directly after charging.
- (2) Connect the fixture with a PD3.0 adapter or power bank via a USB cable.

▲ Note: The adapter and power bank are not included.

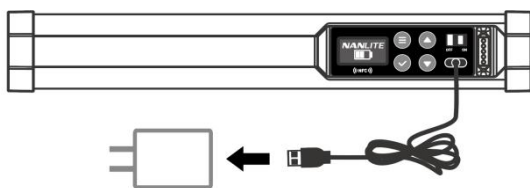

Connect with USB adapter

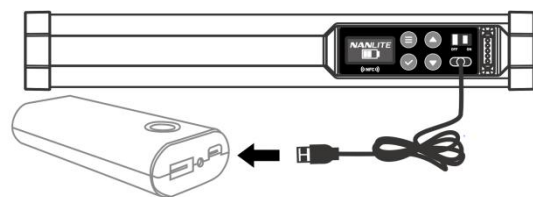

Connect with power bank

5.4. NFC Function

The fixture has a built-in NFC function, allowing it to quickly pair with NFC-enabled devices (with the Nanlink App downloaded), enabling adjustments to DMX control parameters.

6. Troubleshooting for Common Issues

Issues	Troubleshooting Guide
The fixture can't power up.	<ol style="list-style-type: none"> 1. Please check whether the built-in battery is charged. 2. Please check whether the connections between the cable, fixture, and power outlet are loose. 3. Please check whether the power source voltage and frequency is within the specified range.
The fixture can be operated manually, but DMX control is not working.	<ol style="list-style-type: none"> 1. Please check whether the DMX address setting is correct. 2. Please check whether the DMX adapter cable is connected correctly and without damage.

Please scan the QR code for more details



【DMX Charts】



【Nanlite Website】



【Nanlink App】

WWW.NANLITE.COM

NANLITE

✉ info@nanlite.com

☎ +86-754-85751187

☎ +86-754-85300887

📍 Dongli Section, Highway 324, Chenghai, Shantou City, Guangdong Province, China