



2" IC 600 AND 1000 LUMENS LED SQUARE DOWNLIGHT

2LEDTRIM G2 SQ



Project: _____

Fixture Type: _____

Location: _____

Contact/Phone: _____

PRODUCT DESCRIPTION

2 inch aperture recessed downlight is IC rated for insulated or non-insulated applications • Luminaire produces up to 1000 lumens and is available with optical distributions approximating that of 75W MR16 halogen lamps • Low profile form factor allows luminaire to fit in 2 x 6 construction • Designed to provide 50,000 hours of life • 5 year limited warranty on LED Components.

ENVIRONMENTALLY FRIENDLY, ENERGY EFFICIENT

- No harmful ultraviolet or infrared wavelengths
- No lead or mercury, RoHS compliant
- Comparable light output up to a 75W MR16 halogen lamp

PRODUCT SPECIFICATIONS

LED Light Engine Exceptional fixture to fixture color consistency within a 3-step MacAdam ellipse • 2700K, 3000K, 3500K, and 4000K color temperatures are available with 80 CRI or 90 CRI minimum.

Modular Optics Available with field interchangeable optics in 18° Spot, 24° Narrow Flood, or 40° Flood distributions.

Aesthetic Trim Trim features die cast beveled knife edge trim ring for clean ceiling interface available in white, black, satin nickel, or brushed bronze • Die cast baffles are available in white, black, satin nickel, or brushed bronze

LED Driver Choice of dedicated 120 volt (120) driver or universal voltage (MVOLT) driver that accommodates input voltages from 120-277 volts AC at 50/60Hz • Power factor > 0.9 • Dedicated 120 volt driver (120) is dimmable with the use of most incandescent, magnetic low voltage and electronic low voltage dimmers • Universal voltage driver (MVOLT) is dimmable with the use of most 0-10V protocol dimmers • For a list of compatible dimmers, see [JUNO2ING2-DIM](#).

Life Rated for 50,000 hours at 70% lumen maintenance.

Labels ENERGY STAR® Certified • 90CRI fixtures are certified to the high efficacy requirements of California T24 JA8-2016 • Meets energy code Air Leakage requirements per ASTM E283 • UL and cUL listed for wet locations • 2NCHSG option is compatible with spray foam insulation with an R-value of 3.2 per inch or less.

Junction Box Includes (2) 1/2" knock-outs equipped with pryout slots • Push-in electrical connectors for field connections.

Mounting Remodel style plaster frame installs from below the ceiling and accommodates ceiling thicknesses from 1/2" to 1" • For thicker ceilings up to 1 1/2", order 2JCTA150 • New Construction mounting frame, 2NCMF, is also available with Patented (US Patent D552,969) Real Nail 3® telescoping bar hangers to position fixture and locate wiring prior to ceiling installation • Recommend a minimum of 5.5" cavity depth to install properly • Flexible supply is recommended and non-flexible supply requires top access.

Real Nail 3 Bar Hangers 2NCHSG new construction housing and new construction mounting frame, 2NCMF, available with telescoping Real Nail® 3 system which permits quick placement of housing anywhere within 24" O.C. joists or suspended ceilings • Includes removable nail for repositioning of fixture in wood joist construction • Integral T-bar notch and clip for suspended ceilings • Design covered under US Patent D552,969 • 2NCHSG requires 2x8 construction

Specifications subject to change without notice.



Downlight Reflector Finishes

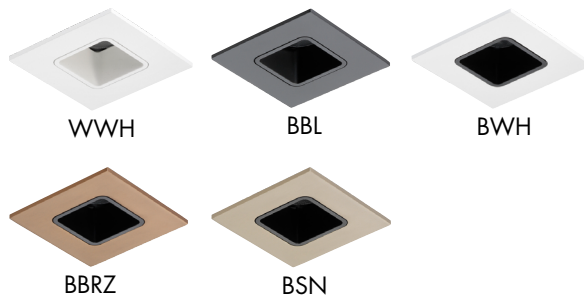

DIMENSIONS

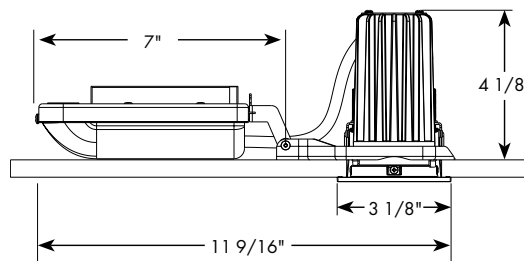

2 5/8" CIRCULAR CEILING CUTOUT
1 1/2" SQ APERTURE

ELECTRICAL DATA (600L)

	Dedicated 120V (120)	Universal Voltage (MVOLT)	
Voltage	120	120	277
Input Power	7.5 (±5%)	7.2	7.5 (±5%)
Input Current	.06	.06	.03
Frequency	50/60Hz	50/60Hz	
Power Factor	>0.9	>0.9	>0.9

ELECTRICAL DATA (1000L)

	Dedicated 120V (120)	Universal Voltage (MVOLT)	
Voltage	120	120	277
Input Power	11.5 (±5%)	10.9	11.4 (±5%)
Input Current	.10	.09	.04
Frequency	50/60Hz	50/60Hz	
Power Factor	>0.9	>0.9	>0.9

2" IC 600 AND 1000 LUMENS LED SQUARE DOWNLIGHT 2LEDTRIM G2 SQ

ORDERING INFORMATION DRIVER AND TRIM EACH ORDERED SEPARATELY.

DRIVER:

Example: 2LEDDRIVER G2 06LM 120 FRPC

Series	Generation	Lumens	Voltage	Driver
2LEDDRIVER Juno Recessed 2" Driver	G2 Generation 2	06LM 600 Nominal Lumens 10LM 1000 Nominal Lumens	120 120V MVOLT Multi-Volt (120-277V)	FRPC Forward/Reverse Phase Cut ZT 0-10V Dimming

Note: 120V must be ordered with FRPC.
MVOLT must be ordered with ZT

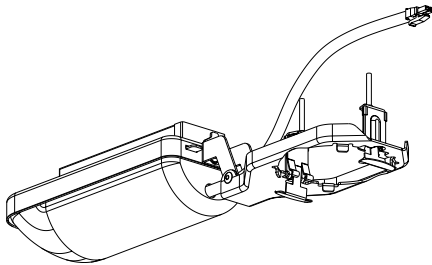

MOUNTING FRAME/DRIVER ASSEMBLY

Note: Driver assembly only intended for use with Gen2 LED trim modules. Not backward compatible with previous generation.

TRIM:

Example: 2LEDTRIM G2 SQ 27K 80CRI FL BBL

Series	Generation	Trim Designation	Color Temperature	CRI	Distribution	Trim Finish
2LEDTRIM Juno Recessed 2" LED Trim	G2 Generation 2	SQ Square Downlight	27K 2700K 30K 3000K 35K 3500K 40K 4000K	80CRI 80+ CRI 90CRI 90+ CRI	FL Flood NFL Narrow Flood SP Spot	BBL Black Baffle, Black Trim Ring BBRZ Black Baffle, Bronze Trim Ring BSN Black Baffle, Satin Nickel Trim BWH Black Baffle, White Trim Ring WWH White Baffle, White Trim Ring

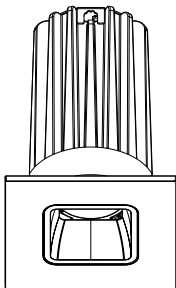

TRIM/LED ASSEMBLY

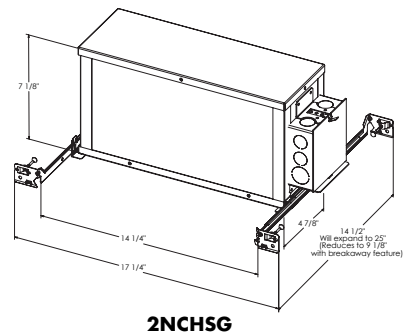
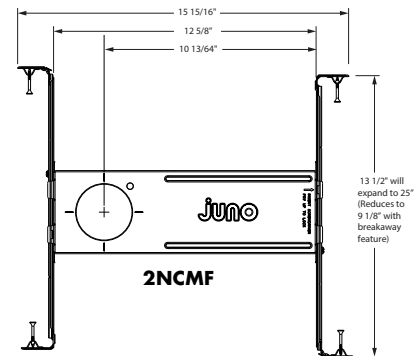

Catalog No.	Description
2NCMF	New Construction Mounting Frame with Real Nail® 3 bar hangers
2NCHSG	2" New Construction Housing for spray foam installation
2DTCA	2" LED Drop Tile Ceiling Adapter
2JCTA150	Thick Ceiling adapter for 1" - 1 1/2" thick ceiling
LEDOPTIC2 SP	18° Spot Optic
LEDOPTIC2 NFL	24° Narrow Flood Optic
LEDOPTIC2 FL	40° Flood Optic

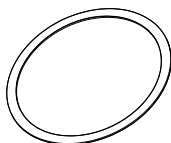

2DTCA

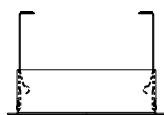

2JCTA150

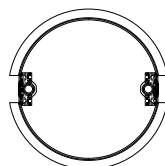

2" IC 600 AND 1000 LUMENS LED SQUARE DOWNLIGHT

2LEDTRIM G2 SQ

PHOTOMETRICS

PHOTOMETRIC REPORT

Test Report#: PT07162007
 Catalog No: 2LEDTRIM G2 SQ 35K 80CRI
 SP WWH (600L), Downlight
 with Spot Optic

Luminaire Spacing Criteria: 0.34
 Luminaire LPW: 92

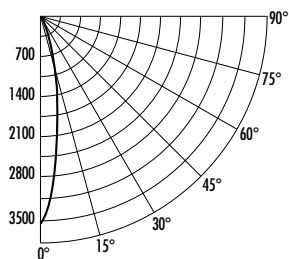

CANDLEPOWER DISTRIBUTION (Candelas)

Degrees Vertical	0°
0	3575
5	3068
15	929
25	134
35	33
45	17
55	15
65	11
75	6
85	2
90	0

AVERAGE INITIAL FOOTCANDLES

Multiple Units (Square Array, 60'x60' room)
 Reflectances: Ceiling 80%, Wall 50%, Floor 20%

Spacing	RCR1	RCR3	RCR5
4'	48	43	40
5'	31	28	26
6'	21	19	18
7'	17	16	14
8'	14	12	11
9'	11	9	9
10'	8	7	6

INITIAL FOOTCANDLES

(One Unit, 7.5W, 19.7° Beam)

Distance to Illuminated Plane (Feet)	Footcandles Beam Center	Beam Diameter
4'	223.4	1.4
6'	99.3	2.1
8'	55.9	2.8
10'	35.8	3.5
12'	24.8	4.2

ZONAL LUMEN SUMMARY

Zone	Lumens	%Lamp	%Fixture
0-30°	618	N/A	89.6
0-40°	643	N/A	93.3
0-60°	670	N/A	97.2
0-90°	689	N/A	100.0

LUMINANCE (Average cd/m²)

Degrees	Average Luminance
45°	17637
55°	18879
65°	18731
75°	18466
85°	13710

PHOTOMETRIC REPORT

Test Report#: PT07162008
 Catalog No: 2LEDTRIM G2 SQ 35K 80CRI
 NFL WWH (600L), Downlight
 with Narrow Flood Optic

Luminaire Spacing Criteria: 0.42
 Luminaire LPW: 86

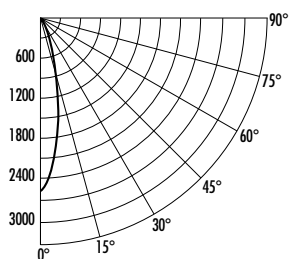

CANDLEPOWER DISTRIBUTION (Candelas)

Degrees Vertical	0°
0	2601
5	2309
15	961
25	174
35	31
45	17
55	14
65	10
75	6
85	1
90	0

AVERAGE INITIAL FOOTCANDLES

Multiple Units (Square Array, 60'x60' room)
 Reflectances: Ceiling 80%, Wall 50%, Floor 20%

Spacing	RCR1	RCR3	RCR5
4'	45	40	37
5'	29	26	24
6'	20	18	16
7'	16	15	13
8'	13	11	11
9'	10	9	8
10'	7	6	6

INITIAL FOOTCANDLES

(One Unit, 7.5W, 24.7° Beam)

Distance to Illuminated Plane (Feet)	Footcandles Beam Center	Beam Diameter
4'	162.5	1.8
6'	72.2	2.6
8'	40.6	3.5
10'	26.0	4.4
12'	18.1	5.3

ZONAL LUMEN SUMMARY

Zone	Lumens	%Lamp	%Fixture
0-30°	575	N/A	88.9
0-40°	600	N/A	93.1
0-60°	627	N/A	97.2
0-90°	645	N/A	100.0

LUMINANCE (Average cd/m²)

Degrees	Average Luminance
45°	18060
55°	18098
65°	17847
75°	17312
85°	11996

PHOTOMETRIC REPORT

Test Report#: PT07162009
 Catalog No: 2LEDTRIM G2 SQ 35K 80CRI
 FL WWH (600L), Downlight
 with Flood Optic

Luminaire Spacing Criteria: 0.68
 Luminaire LPW: 93

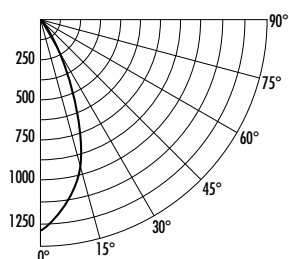

CANDLEPOWER DISTRIBUTION (Candelas)

Degrees Vertical	0°
0	1268
5	1220
15	929
25	400
35	76
45	28
55	15
65	12
75	7
85	2
90	0

AVERAGE INITIAL FOOTCANDLES

Multiple Units (Square Array, 60'x60' room)
 Reflectances: Ceiling 80%, Wall 50%, Floor 20%

Spacing	RCR1	RCR3	RCR5
4'	49	42	38
5'	31	27	24
6'	22	19	17
7'	17	15	14
8'	14	12	11
9'	11	9	8
10'	8	7	6

INITIAL FOOTCANDLES

(One Unit, 7.5W, 41.6° Beam)

Distance to Illuminated Plane (Feet)	Footcandles Beam Center	Beam Diameter
4'	79.3	3.0
6'	35.2	4.6
8'	19.8	6.1
10'	12.7	7.6
12'	8.8	9.1

ZONAL LUMEN SUMMARY

Zone	Lumens	%Lamp	%Fixture
0-30°	572	N/A	81.8
0-40°	639	N/A	91.4
0-60°	677	N/A	96.8
0-90°	700	N/A	100.0

LUMINANCE (Average cd/m²)

Degrees	Average Luminance
45°	29572
55°	18879
65°	21205
75°	21352
85°	16280

Fixtures tested to IES recommended standard for solid state lighting per LM-79-08. Photometric performance on a single unit represents a baseline of performance for the fixture. Results may vary in the field.

Multiplier:	80 CRI	90 CRI
	27K = .94	27K = .83
	30K = .97	30K = .86
	35K = 1.00	35K = .88
	40K = 1.03	40K = .90

2" IC 600 AND 1000 LUMENS LED SQUARE DOWNLIGHT 2LEDTRIM G2 SQ

PHOTOMETRICS

PHOTOMETRIC REPORT

Test Report#: PT07162007R
Catalog No: 2LEDTRIM G2 SQ 35K 80CRI
SP WWH (1000L), Downlight
with Spot Optic
Luminaire Spacing Criteria: 0.34
Luminaire LPW: 91

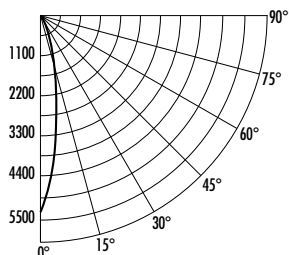

CANDLEPOWER DISTRIBUTION (Candelas)

Degrees Vertical	0°
0	5398
5	4633
15	1403
25	203
35	50
45	25
55	22
65	16
75	10
85	2
90	0

AVERAGE INITIAL FOOTCANDLES Multiple Units (Square Array, 60'x60' room)

Reflectances: Ceiling 80%, Wall 50%, Floor 20%

Spacing	RCR1	RCR3	RCR5
4'	73	66	61
5'	47	42	39
6'	32	29	27
7'	26	24	22
8'	21	19	17
9'	16	14	13
10'	12	11	10

ZONAL LUMEN SUMMARY

Zone	Lumens	%Lamp	%Fixture
0-30°	933	N/A	89.6
0-40°	971	N/A	93.3
0-60°	1012	N/A	97.2
0-90°	1041	N/A	100.0

INITIAL FOOTCANDLES

(One Unit, 11.5W, 19.7° Beam)

Distance to Illuminated Plane (Feet)	Footcandles Beam Center	Beam Diameter
4'	337.4	1.4
6'	149.9	2.1
8'	84.3	2.8
10'	54.0	3.5
12'	37.5	4.2

LUMINANCE (Average cd/m²)

Degrees	Average Luminance
45°	26632
55°	28507
65°	28284
75°	27884
85°	20701

PHOTOMETRIC REPORT

Test Report#: PT07162008R
Catalog No: 2LEDTRIM G2 SQ 35K 80CRI
NFL WWH (1000L), Downlight
with Narrow Flood Optic
Luminaire Spacing Criteria: 0.42
Luminaire LPW: 86

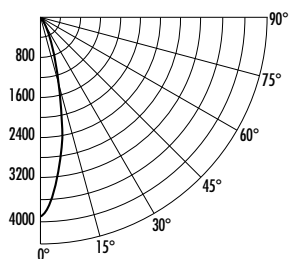

CANDLEPOWER DISTRIBUTION (Candelas)

Degrees Vertical	0°
0	3979
5	3532
15	1469
25	267
35	48
45	26
55	21
65	15
75	9
85	2
90	0

AVERAGE INITIAL FOOTCANDLES Multiple Units (Square Array, 60'x60' room)

Reflectances: Ceiling 80%, Wall 50%, Floor 20%

Spacing	RCR1	RCR3	RCR5
4'	69	62	57
5'	44	39	36
6'	31	27	25
7'	25	22	20
8'	20	18	16
9'	15	13	12
10'	11	10	9

ZONAL LUMEN SUMMARY

Zone	Lumens	%Lamp	%Fixture
0-30°	878	N/A	88.9
0-40°	919	N/A	93.1
0-60°	959	N/A	97.2
0-90°	987	N/A	100.0

INITIAL FOOTCANDLES

(One Unit, 11.5W, 24.7° Beam)

Distance to Illuminated Plane (Feet)	Footcandles Beam Center	Beam Diameter
4'	248.7	1.8
6'	110.5	2.6
8'	62.2	3.5
10'	39.8	4.4
12'	27.6	5.3

LUMINANCE (Average cd/m²)

Degrees	Average Luminance
45°	27631
55°	27690
65°	27306
75°	26488
85°	18354

PHOTOMETRIC REPORT

Test Report#: PT07162009R
Catalog No: 2LEDTRIM G2 SQ 35K 80CRI
FL WWH (1000L), Downlight
with Flood Optic
Luminaire Spacing Criteria: 0.68
Luminaire LPW: 94

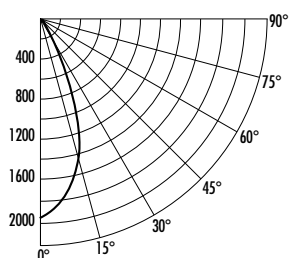

CANDLEPOWER DISTRIBUTION (Candelas)

Degrees Vertical	0°
0	1953
5	1879
15	1430
25	615
35	118
45	43
55	22
65	18
75	11
85	3
90	0

AVERAGE INITIAL FOOTCANDLES Multiple Units (Square Array, 60'x60' room)

Reflectances: Ceiling 80%, Wall 50%, Floor 20%

Spacing	RCR1	RCR3	RCR5
4'	75	65	59
5'	48	42	37
6'	33	29	26
7'	27	24	21
8'	21	19	17
9'	16	14	13
10'	12	10	9

ZONAL LUMEN SUMMARY

Zone	Lumens	%Lamp	%Fixture
0-30°	881	N/A	81.8
0-40°	985	N/A	91.4
0-60°	1043	N/A	96.8
0-90°	1077	N/A	100.0

INITIAL FOOTCANDLES

(One Unit, 11.5W, 41.6° Beam)

Distance to Illuminated Plane (Feet)	Footcandles Beam Center	Beam Diameter
4'	122.1	3.0
6'	54.3	4.6
8'	30.5	6.1
10'	19.5	7.6
12'	13.6	9.1

LUMINANCE (Average cd/m²)

Degrees	Average Luminance
45°	45540
55°	29074
65°	32655
75°	32882
85°	25071

Fixtures tested to IES recommended standard for solid state lighting per LM-79-08. Photometric performance on a single unit represents a baseline of performance for the fixture. Results may vary in the field.

Multiplier:	80 CRI	90 CRI
	27K = .94	27K = .83
	30K = .97	30K = .86
	35K = 1.00	35K = .88
	40K = 1.03	40K = .90