



ANZZI®

FT-AZ067 JERICHO

AIR JETTED FREESTANDING BATHTUB
WITH CHROMA-LIGHTS

INSTALL & OPERATION MANUAL

V3.1

11/18/2024

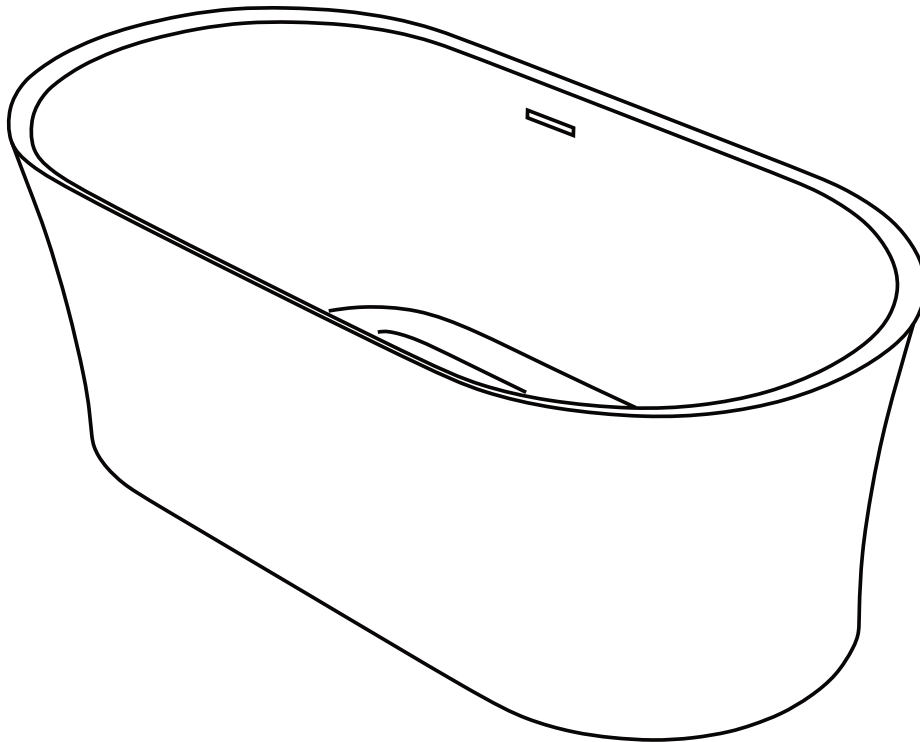

DON'T WAIT! REGISTER NOW!

Register your product within 30 days to ensure your bathtub is recognized as an official purchase and is eligible for warranty coverage.

Register online at <https://anzzi.com/pages/register> or scan the QR code at PG.2.



PRODUCT REGISTRATION*

IMPORTANT: Warranty will not be recognized unless product is registered.

Register online at <https://anzzi.com/pages/register> or Scan the QR code below.

Registering online is fast, secure, and ensures we receive your information.

1

USE YOUR PHONE CAMERA
TO SCAN THE QR CODE

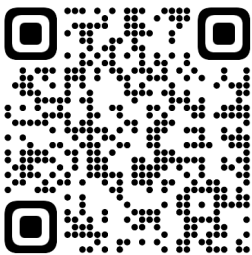

2

FILL IN A QUICK
REGISTRATION FORM

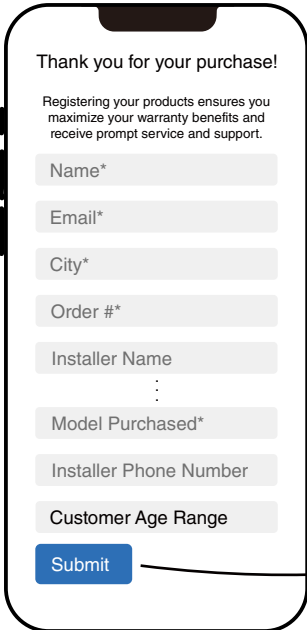

3

CLICK SUBMIT AND
ENJOY PEACE OF MIND

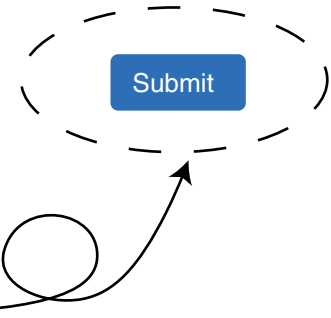

ANZZI®



FT-AZ067

AIR JETTED FREESTANDING BATHTUB

INCLUDES:

AERO-THERAPEUTIC
BUBBLE MASSAGE SYSTEM

4 CHROMA-THERAPEUTIC
BATHING LIGHTS

FEATHER TOUCH LIGHT-UP
CONTROL PAD

BUILT-IN OVERFLOW
AND POP-UP DRAIN

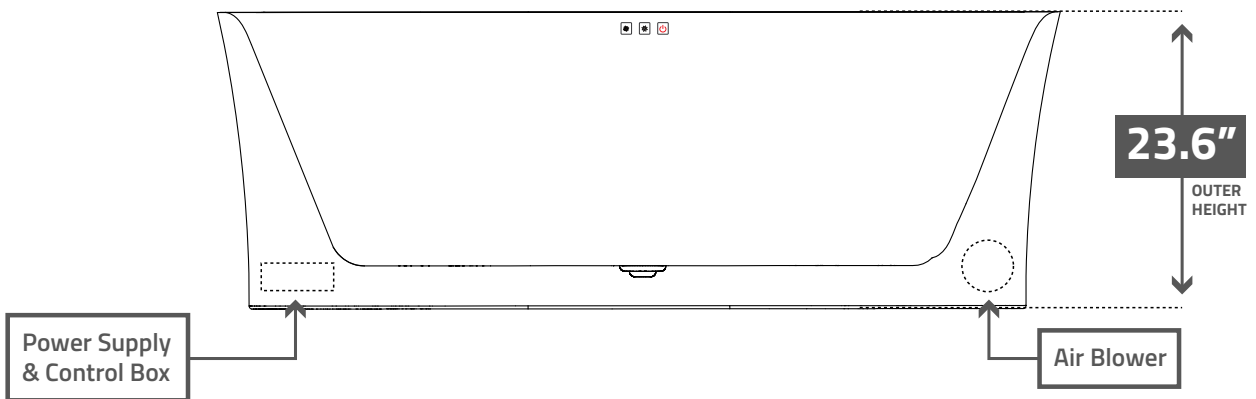
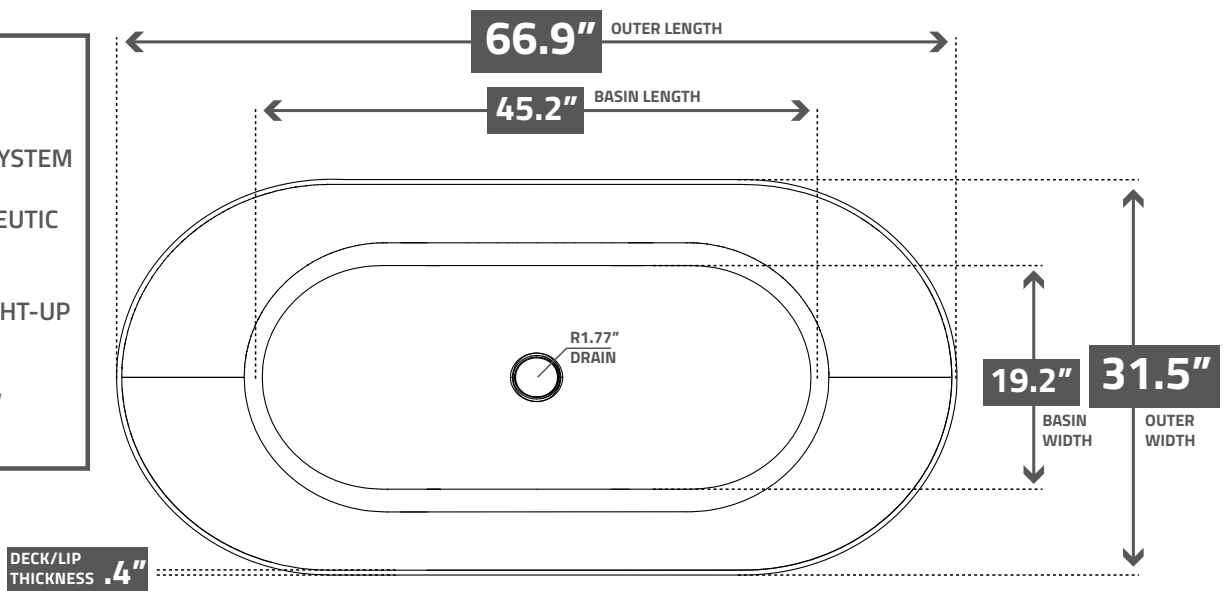



SAVE THIS MANUAL!

READ THESE INSTRUCTIONS COMPLETELY BEFORE INSTALLING THE PRODUCTS. FAILURE TO DO SO COULD RESULT IN AN IMPROPER INSTALLATION AND COULD VOID THE WARRANTY.

RESPONSIBILITY OF THE INSTALLER!

THE INSTALLER MUST INSPECT AND WATER TEST THE PRODUCT PRIOR TO INSTALLATION TO ENSURE THE UNIT IS FREE OF DEFECT OR DAMAGE. IN THE EVENT OF A PROBLEM, THE UNIT MUST NOT BE INSTALLED. IF THE CRATE OR THE PRODUCT HAS BEEN DAMAGED DURING SHIPPING, PLEASE CALL US IMMEDIATELY.

THIS PRODUCT MUST BE INSTALLED BY A LICENSED/CERTIFIED CONTRACTOR!

LICENSED PLUMBERS AND ELECTRICIANS SHOULD BE EMPLOYED TO INSURE PROPER INSTALLATION. INSTALLERS ASSUME ALL LIABILITY FOR THE CORRECT INSTALLATION PROCEDURES. ONLY ACCESSORIES AUTHORIZED BY THE MANUFACTURER SHOULD BE USED WITH THIS PRODUCT.

WARNING! WHEN USING THIS PRODUCT, BASIC PRECAUTIONS SHOULD ALWAYS BE FOLLOWED. READ AND FOLLOW ALL INSTRUCTIONS PERTAINING TO RISK OF FIRE, ELECTRICAL SHOCK, AND/OR OTHER INJURIES.

REPORT DAMAGES RIGHT AWAY! REPORT ANY DAMAGES TO THE BATHTUB WITHIN 5 BUSINESS DAYS. ANY DAMAGES DONE BEYOND THAT WILL BE ASSUMED TO HAVE HAPPENED DURING AND AFTER THE INSTALLATION.

TEST THE TUB BEFORE INSTALLATION! BEFORE PERMANENTLY INSTALLING THE BATHTUB, YOUR INSTALLER MUST TEST THE BATH. USE THE PROVIDED FLEX DRAIN, PLUG IN THE TUB AND POWER IT ON. RUN THE LIGHTS AND AIR JETS. ALSO, INSPECT FOR ANY LEAKING. ONLY IF THERE ARE NO SIGNS OF MALFUNCTION OR LEAKAGE SHOULD YOU PROCEED TO PERMANENTLY INSTALL THE UNIT.

LEVEL THE TUB AND AVOID LEAKAGE! CHECK THE AREA PRIOR TO INSTALLATION. USE THE JERICHO'S ADJUSTABLE FEET TO ENSURE THE BATHTUB IS PERFECTLY LEVEL. IT IS ESSENTIAL THAT ALL THE FEET ARE TOUCHING THE FLOOR/SURFACE. AN UNLEVELED TUB WILL RESULT IN LEAKAGE.



SAFETY INSTRUCTIONS

READ THESE INSTRUCTIONS COMPLETELY BEFORE INSTALLING THE PRODUCTS. FAILURE TO DO SO COULD RESULT IN AN IMPROPER INSTALLATION AND COULD VOID THE WARRANTY.

IMPORTANT SAFETY INSTRUCTIONS. INSTRUCTIONS IMPORTANTES RELATIVES A LA SECURITE.

READ AND FOLLOW ALL INSTRUCTIONS. LIRE ET SUIVRE TOUTES LES INSTRUCTIONS.

SAVE THESE INSTRUCTIONS. CONSERVER CES INSTRUCTIONS.

WARNING: RISK OF ACCIDENTAL INJURY OR DROWNING; CHILDREN SHOULD NOT USE HYDROMASSAGE BATHTUB WITHOUT ADULT SUPERVISION. **AVERTISSEMENT.** RISQUE DE BLESSURE ET DE NOYADE. NE PAS LAISSER UN ENFANT UTILISER LA CUVE A REMOUS EN L'ABSENCE D'UN ADULTE

WARNING: TO AVOID INJURY, EXERCISE CARE WHEN ENTERING OR EXITING THE HYDROMASSAGE BATHTUB. **AVERTISSEMENT.** POUR EVITER LES BLESSURES, USER DE PRUDENCE EN ENTRANT DANS LA CUVE A REMOUS ET EN LA QUITTANT.

WARNING: RISK OF ELECTRIC SHOCK; DO NOT PERMIT ELECTRIC APPLIANCES (SUCH AS A HAIR DRYER, LAMP, TELEPHONE, RADIO, OR TELEVISION) WITHIN 1.5 M OF THIS HYDROMASSAGE BATHTUB. **AVERTISSEMENT.** RISQUE DE CHOC ELECTRIQUE. NE PAS PLACER D'APPAREILS ELECTRIQUES (LUMINAIRE, TÉLÉPHONE, RADIO, TELEVISEUR, ETC.) A MOINS DE 1.5 M DE CETTE CUVE A REMOUS.

CAUTION: TEST THE GROUND FAULT CIRCUIT INTERRUPTER PROTECTING THIS APPLIANCE PERIODICALLY IN ACCORDANCE WITH THE MANUFACTURER'S INSTRUCTIONS. **ATTENTION.** VERIFIER REGULIEREMENT LE FONCTIONNEMENT DU DISJONCTEUR DE FUITE A LA TERRE CONFORMEMENT AUX INSTRUCTIONS DU FABRICANT.

ANZZI®

UNPACK THE BATHTUB

REMOVE THE BATHTUB FROM THE BOX AND PREPARE THE FOLLOWING TOOLS.

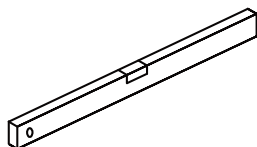
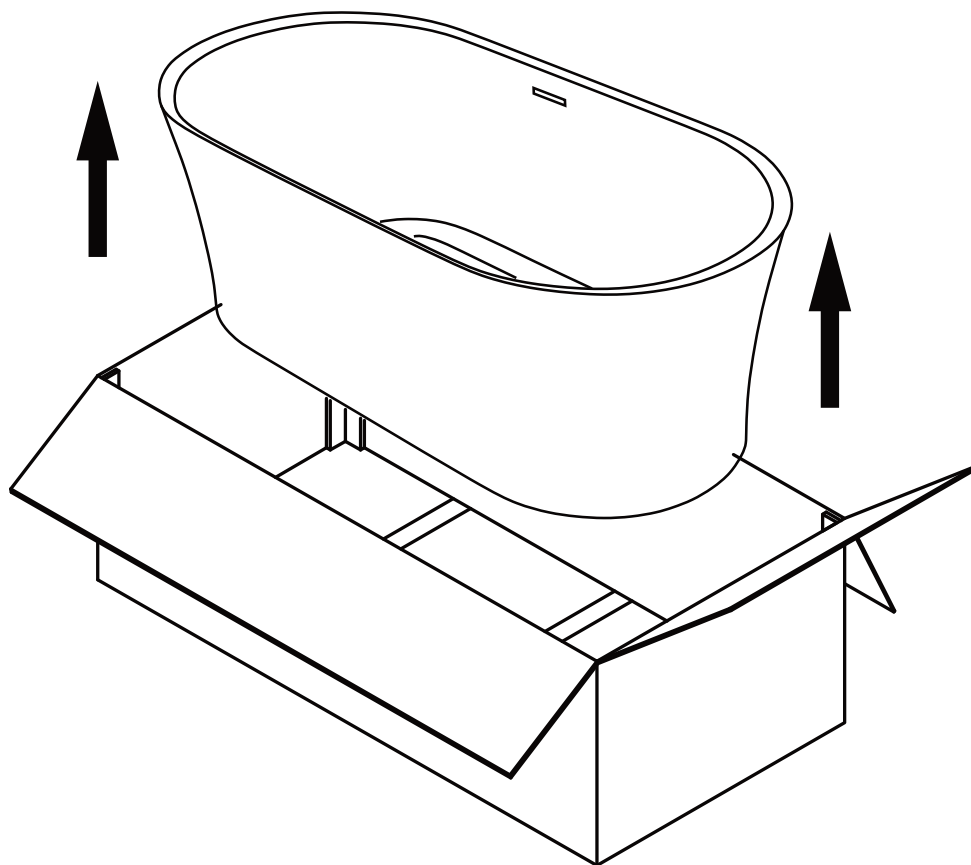

**LEVELER
RULER**
needed



**ADJUSTABLE
WRENCH**
needed



**TEFLON
TAPE**
needed

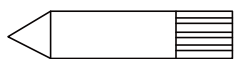

**MARKING
PENCIL**
needed

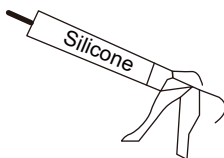

**SILICONE
GUN**
needed

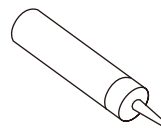

CAULK
needed



** All JERICHO bathtubs are 100% water tested at the factory and certified to be free of leaks. Transportation and mishandling may cause leaks. It is necessary to test the bathtub while there is access to all sides of the bathtub.*

TEST THE BATHTUB WHILE YOU HAVE ACCESS TO THE BOTTOM AND BEFORE PERMANENTLY INSTALLED.

READ AND FOLLOW ALL INSTRUCTIONS

- Place the tub on a completely flat surface in an area where it may be drained after testing.
- Close the drain and fill the tub about half way.
- Allow the water to stand in tub for 30 minutes and then inspect all plumbing and seals for leaks.
- Supply power to unit and run for 10 minutes and inspect for leaks.

NOTE: IF THE PUMPS DO NOT OPERATE, CHECK THE BREAKER TO ENSURE POWER IS ON AND THE CABLE CONNECTING THE CONTROLS TO THE PUMP IS ATTACHED.

WARNING! DO NOT RUN THE PUMP UNLESS THE TUB IS FILLED WITH WATER TO PROPER LEVEL. DAMAGE DUE TO DRY RUNNING PUMPS IS NOT COVERED UNDER WARRANTY. FAILURE TO PERFORM THESE TESTS BEFORE INSTALLATION WILL MAKE THE INSTALLER LIABLE FOR FUTURE REPAIR COSTS.



INSTALLING THE BATHTUB

MOVE THE BATHTUB TO THE SELECTED INSTALLATION POSITION, (MAKE SURE THAT THE FLOOR SURFACE CAN SUPPORT THE LOAD CAPACITY) MAKING SURE IT'S IN THE DESIRED ORIENTATION.

ADD ADHESIVE OR SILICONE AROUND THE BASE AND SUPPORT OF THE TUB.

CAREFULLY SET THE TUB INTO POSITION AND CONNECT THE DRAIN HARDWARE. THE DRAIN SHOULD SLIP INTO THE DRAINAGE PIPE. THEN USE A LEVEL TO ENSURE THE TUB SURFACE IS LEVEL. IF NOT LIFT ONE END OF THE BATHTUB, AND LOOSEN THE ADJUSTING NUT ON THE TUB FOOT AS SHOWN IN THE FIGURE. AFTER ADJUSTING THE LEVELING FOOT TO A SUITABLE POSITION, THEN TIGHTEN SECURING NUT.

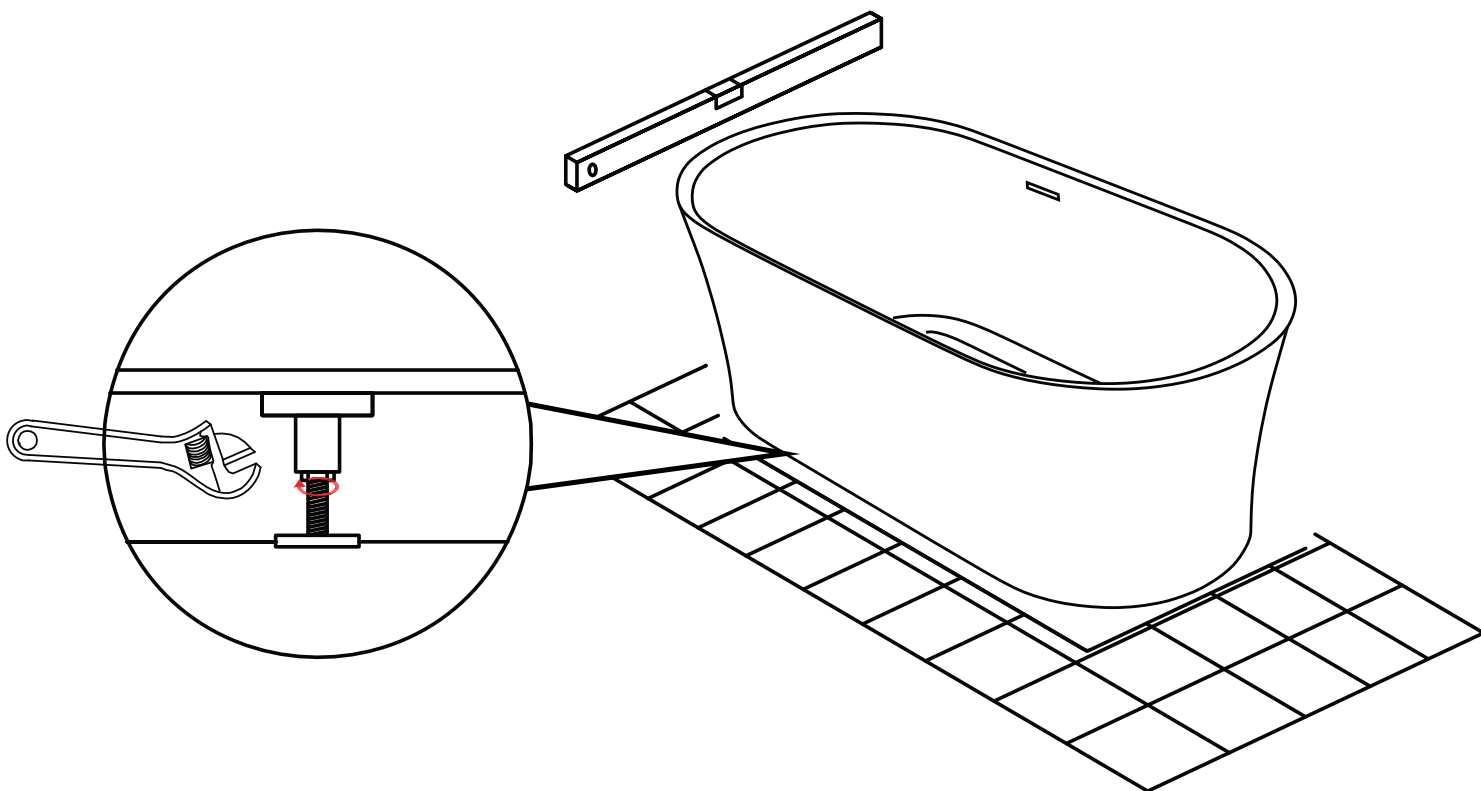



INSTALLING THE BATHTUB

PLUG IN THE ELECTRICAL CORD INTO THE GFCI PROTECTED OUTLET. CONNECT THE DRAIN LINE TO THE TUB DRAIN USING TEFLON TAPE.



ELECTRICAL REQUIREMENTS FOR AIR JETTED BATHTUB

THE UNIT MUST BE CONNECTED ONLY TO A SUPPLY CIRCUIT THAT IS PROTECTED BY A GROUND-FAULT CIRCUIT INTERRUPTER (GFCI). SUCH A GFCI SHOULD BE PROVIDED BY THE INSTALLER.

1. ONE (1) DEDICATED 15AMP 110V GFCI BREAKER IS REQUIRED.

INCOMING POWER

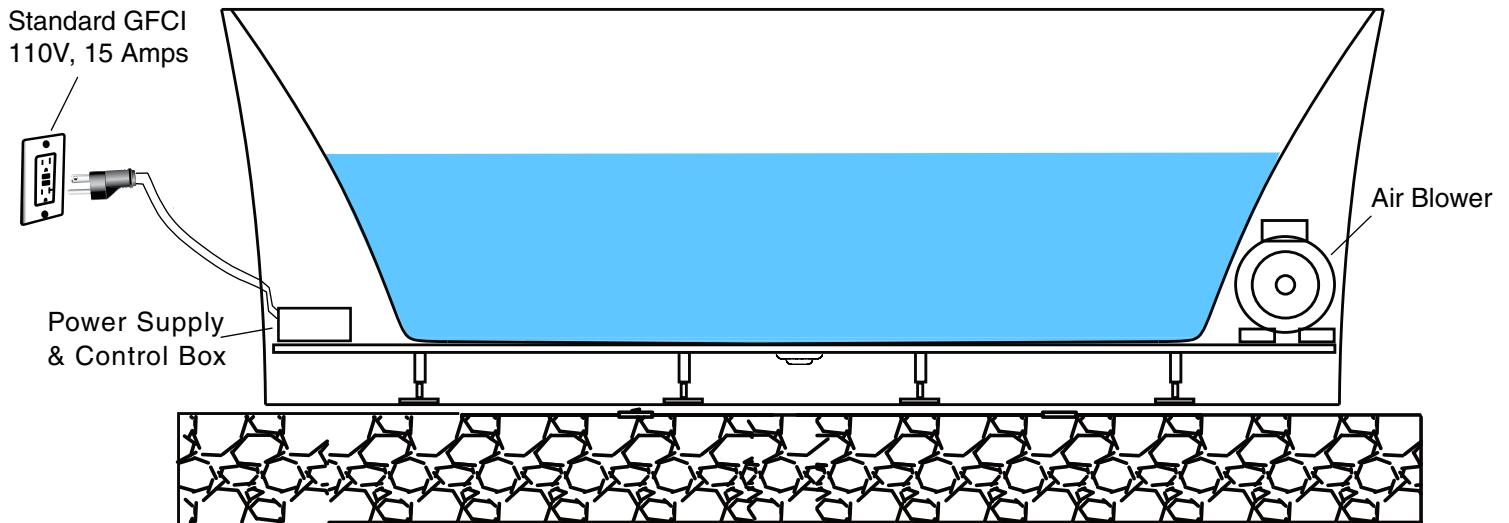
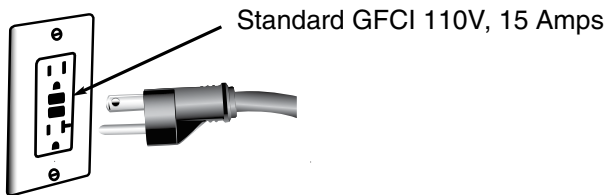

ANZZI®

FILL THE BATHTUB

FINALLY FILL THE BATHTUB WITH WATER. REMEMBER TO ONLY RUN THE AIR JETS WHEN THE TUB IS FILLED WITH WATER.

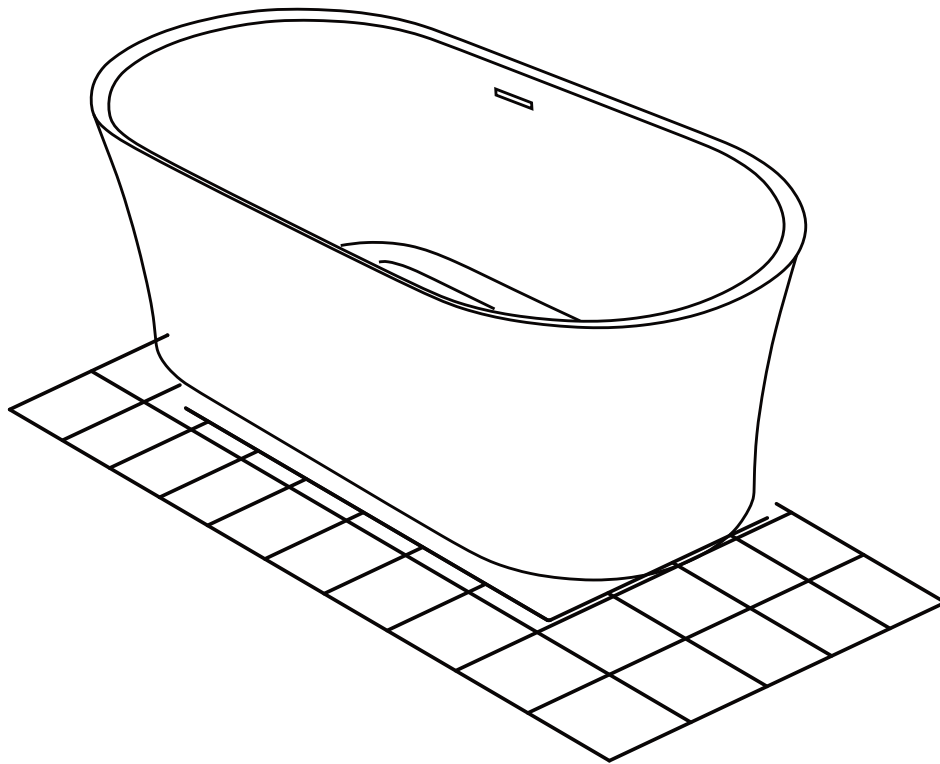

ANZZI®

OPERATING GUIDE

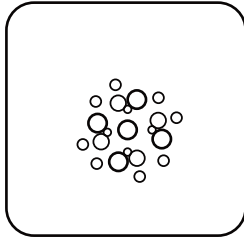

**BUBBLE MASSAGE
ON / OFF BUTTON**

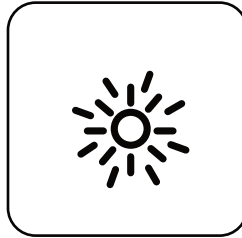

**CHROMA-LIGHT
ON / OFF BUTTON**

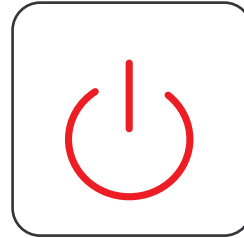

**BATHTUB POWER
ON / OFF BUTTON**



POWER THE BATHTUB

To turn on the system, press the power button, and the indicator light will come on. Then press either the “Light” Button or “Air Pump” button to turn on the desired Function, press again to turn off the function. (While the functions are active, the button will have a red back light, when powered off it will have a white back light).

If no button is pressed for 10 seconds the control buttons will lock, and the “Power” button will begin to flash. To unlock, press and hold the power button for 2 seconds, until the button stops flashing. You can now activate the other buttons as desired. Please note, the system will automatically power itself off after 60 minutes.

Press the “Power” button. If system is locked press and hold the “Power” button for 2 seconds, then press the power button again to turn off the system.

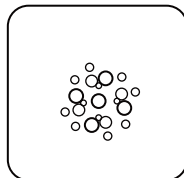

AIR BUBBLE MESSAGE ON/OFF BUTTON

Press to turn the air jets ON or OFF. The air blower should be used when the tub is filled correctly.

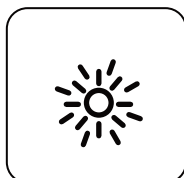

CHROMA-LIGHT ON/OFF BUTTON

To be used for turning the light on / off and changing the light color;

1. Turn on the bath power, the white light is on.
2. Press one time the light button, the light starts the color-setting mode, one press one different color, total eight colors.
3. Long press the light button for 2 seconds till the light button is flashing, the light goes to color auto-cycle mode, 8 colors change automatically.
4. Press the flashing light button, the light color auto-cycle mode stops and starts the color-setting mode. Or long press the flashing light button for 2 seconds, turn off the light.
5. Above operation needs to be in unlocked status. If the system is locked, long press the “Power” button for 2 seconds to unlock.



NEED A FREESTANDING FAUCET OR SHOWER HEAD SYSTEM FOR YOUR NEW BATHTUB? CHECK OUT ANZZI'S EXPANSIVE LUXURY BATH CATALOG.

VISIT WWW.AZZI.COM AND BROWSE THROUGH OUR COLLECTION OF BATHROOM FIXTURES AND ACCESSORIES INSPIRED BY THE LATEST TRENDS AND STYLES.

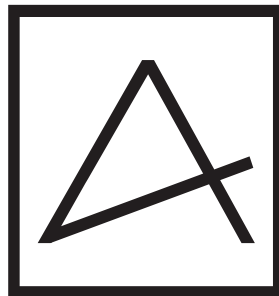

ANZZI®