

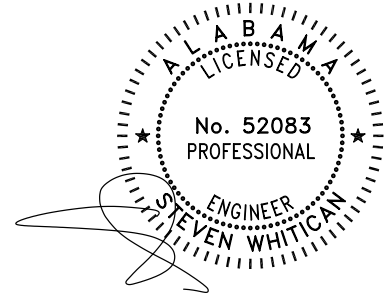

January 30, 2025

To: Whom it may concern,
From: Building Drops, Inc.
On behalf of: Glass Warehouse LLC / FutureGlass
1319 Rocky Point Drive, Suite 200
Oceanside, CA 92056
Report: PER 9361
Subject: Fabrikasi Posted Glass Railing System



Scope:

The purpose of this report is to evaluate the performance of the Fabrikasi Posted Glass Railing System manufactured by Glass Warehouse LLC / FutureGlass. The conditions in this report meet all the applicable requirements of the current International Building Code. Glass thicknesses and properties were extracted from ASTM E1300. Aluminum members and connections were designed according to ADM Design Guides. ICC Acceptance Criteria AC439 and ASTM E2358 were used for determining applicable design criteria for railing systems. A summary of standards can be found on the following pages.

Only rectangular glass is covered within this report, different glass shapes do not apply to this analysis. Gaskets may be modified according to different glass thicknesses as long as thickness is specified in this analysis.

The posted glass railing system uses Aluminum 6063-T5 posts and top rails to support the glass lights specified herein. The posted glass system has been designed for the following loading conditions:

- 200 lb concentrated load at the top of glass or at the top rail
- 50 lbs linear load applied at the top of glass or at the top rail
- Allowable wind load as shown on the tables within this report

This report provides glass thicknesses the posts have been designed to support. Other glass thicknesses may be used but are outside of the scope of this report.

Instructions for Use

1. Select post spacing and height based on jobsite wind loads using tables 2, 4, and 6.
2. Select anchor type with allowable wind load higher than step 1 from tables 7 through 10.
3. Select Glass Type with allowable wind load higher than step 1 from tables 12 through 18.

Project Description: Glass Warehouse LLC / FutureGlass – Fabrikasi Posted Glass Railing System	Date: January 30, 2025	Customer: Glass Warehouse LLC / FutureGlass	
		Project #: EEV-24-0628	
	Engineer: SH	PER: 9361	Page #: Page 1 of 39

Fabrikasi Posted Glass Railing System

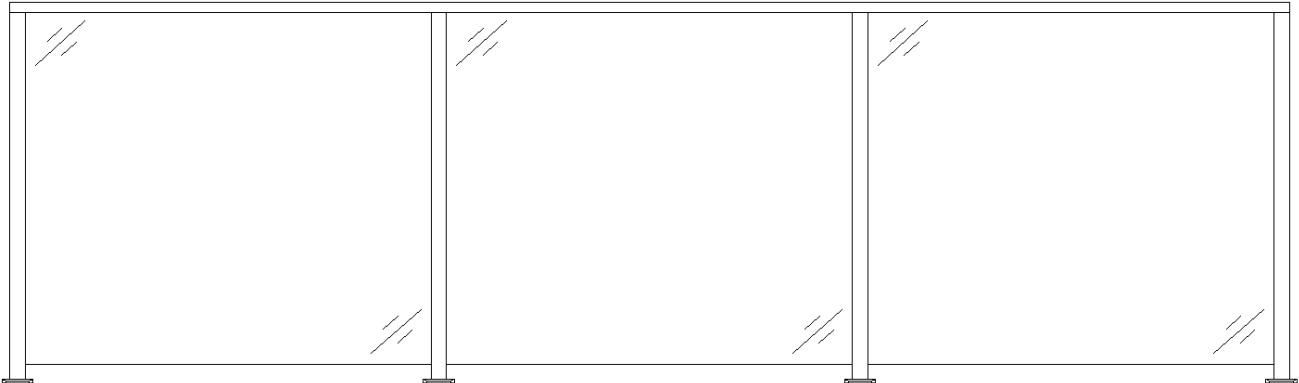

Standards/Referenced Publications

ASTM E1300	IBC 1607.8.1	ICC AC439
ASTM E2358	AISC Design Guides	ASTM C1048-97b
CPSC 16 CFR 1201	ANSI Z97.1	AAMA CW-12-84, Structural Properties for glass
ADM 2018	IBC 2407.1.1	NDS 2018
ASTM E6.2.1.1	SEI/ASCE 8-02	

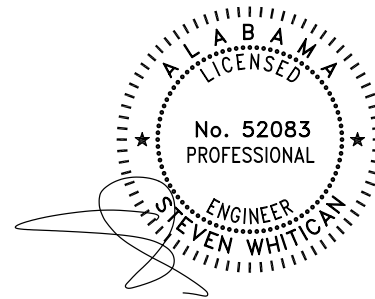

Limits of Use:

1. This product has been evaluated and is in compliance with the 2015, 2018, and 2021 editions of the International Building Code.
2. Product installation shall be as listed herein. Site conditions that deviate from those specified shall require further engineering analysis by a licensed engineer or registered architect.
3. When used in areas requiring wind borne debris protection this product complies with chapter 16 of the 2015, 2018, and 2021 editions of the International Building Code and does require an impact resistant covering in areas requiring impact resistance.

Project Description: Glass Warehouse LLC / FutureGlass – Fabrikasi Posted Glass Railing System	Date: January 30, 2025	Customer: Glass Warehouse LLC / FutureGlass	
		Project #: EEV-24-0628	
	Engineer: SH	PER: 9361	Page #: Page 2 of 39



YOU ENVISION IT – WE ENGINEER IT

1900 NE Miami Ct., Ste. 2-15
Miami, FL 33132
TEL: 954.399-8478 | FAX: 954.744.4738
WEB: www.buildingdrops.com

Conclusion:

In my professional opinion, the Fabrikasi Posted Glass Railing System manufactured by Glass Warehouse LLC / FutureGlass is adequate for use under the limitations provided within this report.

I trust that this will satisfy your needs, however, feel free to call if you have any questions.

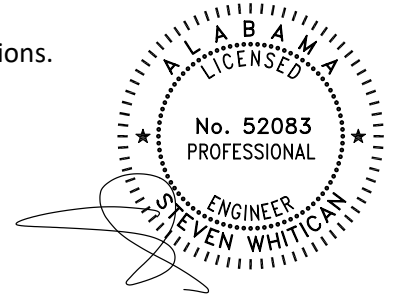

Certification of Independence: Please note that I do not have nor will I acquire a financial interest in any company manufacturing or distributing the product(s) for which this report is being issued. Also, I do not have nor will I acquire a financial interest in any other entity involved in the approval process of the listed product(s).

Project Description: Glass Warehouse LLC / FutureGlass – Fabrikasi Posted Glass Railing System	Date: January 30, 2025	Customer: Glass Warehouse LLC / FutureGlass	
		Project #: EEV-24-0628	
	Engineer: SH	PER: 9361	Page #: Page 3 of 39



Analysis and Findings:

Posts Allowable Heights and Wind Loads:

The stainless-steel post was analyzed for the maximum allowable heights at various post spacings due to the following design loads:

- 200 lb Concentrated Load at the top of the post
- 50 lb/ft Linear Load along the handrail or along the top of the glass
- Allowable Wind Load due to Post Spacing and Height

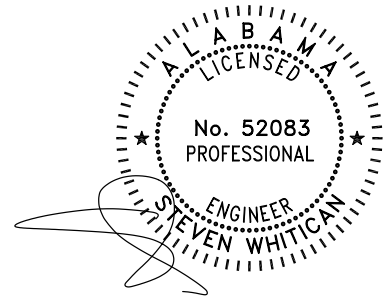

Intermediate Post Analysis:

Table 1: Maximum Allowable Height of Post

Max. Allowable Height (in.)							
Post Spacing (in.)							
36	42	48	54	60	66	72	78
78.11	78.11	78.11	69.43	62.49	56.81	52.07	48.07

Table 2: Maximum Allowable Wind Load of Post

ALLOWABLE POST WIND LOAD (PSF)								
POST HEIGHT (IN.)	POST SPACING (IN.)							
	36	42	48	54	60	66	72	78
36	87.66	75.14	65.75	58.44	52.60	47.82	43.83	40.46
42	64.41	55.21	48.31	42.94	38.64	35.13	32.20	29.73
48	49.31	42.27	36.98	32.87	29.59	26.90	24.66	22.76
54	38.96	33.40	29.22	25.97	23.38	21.25	-	-
60	31.56	27.05	23.67	21.04	18.94	-	-	-

*Note: Cells in table which have a “-” are not qualified under this report due to the maximum height being exceeded from the values shown in table 1.

Project Description: Glass Warehouse LLC / FutureGlass – Fabrikasi Posted Glass Railing System	Date: January 30, 2025	Customer: Glass Warehouse LLC / FutureGlass	
	Engineer: SH	Project #: EEV-24-0628	
	PER: 9361	Page #: Page 4 of 39	

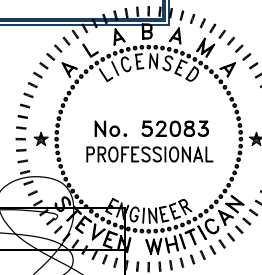

End Post Analysis:

Table 3: Maximum Allowable Height of Post

Max. Allowable Height (in.)							
Trib. Post Spacing (in.)							
36	42	48	54	60	66	72	78
74.34	74.34	74.34	74.34	74.34	74.34	74.34	74.34

Table 4: Maximum Allowable Wind Load of Post

ALLOWABLE POST WIND LOAD (PSF)								
POST HEIGHT (IN.)	POST SPACING (IN.)							
	36	42	48	54	60	66	72	78
36	166.87	143.03	125.15	111.25	100.12	91.02	83.43	77.02
42	122.60	105.08	91.95	81.73	73.56	66.87	61.30	56.58
48	93.86	80.45	70.40	62.58	56.32	51.20	46.93	43.32
54	74.16	63.57	55.62	49.44	44.50	40.45	37.08	34.23
60	60.07	51.49	45.05	40.05	36.04	32.77	30.04	27.73

90° Corner Post Analysis:

Table 5: Maximum Allowable Height of Post

Max. Allowable Height (in.)							
Trib. Post Spacing (in.)							
36	42	48	54	60	66	72	78
59.47	59.47	59.47	59.47	59.47	59.47	59.47	59.47

Table 6: Maximum Allowable Wind Load of Post

ALLOWABLE POST WIND LOAD (PSF)								
POST HEIGHT (IN.)	POST SPACING (IN.)							
	36	42	48	54	60	66	72	78
36	133.49	114.42	100.12	89.00	80.10	72.82	66.75	61.61
42	98.08	84.07	73.56	65.39	58.85	53.50	49.04	45.27
48	75.09	64.36	56.32	50.06	45.05	40.96	37.55	34.66
54	59.33	50.86	44.50	39.55	35.60	32.36	29.67	27.38
60	-	-	-	-	-	-	-	-

Project Description: Glass Warehouse LLC / FutureGlass – Fabrikasi Posted Glass Railing System	Date: January 30, 2025	Customer: Glass Warehouse LLC / FutureGlass	
	Engineer: SH	Project #: EEV-24-0628	
	PER: 9361	Page #: Page 5 of 39	



YOU ENVISION IT – WE ENGINEER IT

1900 NE Miami Ct., Ste. 2-15
 Miami, FL 33132
 TEL: 954.399-8478 | FAX: 954.744.4738
 WEB: www.buildingdrops.com

Post Installation Analysis:

Anchor Summary Table

Anchor Schedule						
Option	Anchor Type	Brand	Substrate Capacity	Anchor Diameter (in.)	Embedment (in.)	Edge Distance (in.)
A	Wood	5/16" Lag Screw	0.55 S.G.	0.3125	1.50	0.75
B		3/8" Lag Screw	0.55 S.G.	0.375	1.50	0.75
C		1/2" Lag Screw	0.55 S.G.	0.5	1.50	0.75
D	Steel	5/16" Self-Tapping Screw	45000 psi	0.3125	3 Threads	0.50
E		3/8" Self-Tapping Screw	45000 psi	0.375	3 Threads	0.50
F		1/2" Self-Tapping Screw	45000 psi	0.5	3 Threads	0.50
G	Concrete	1/4" Dewalt Screw-Bolt+	3000 psi	0.25	2.50	3.00
H		3/8" Dewalt Screw-Bolt+	3000 psi	0.375	2.50	3.00
I		1/2" Dewalt Screw-Bolt+	3000 psi	0.5	2.50	3.00

Table 7: Anchor Type G

ALLOWABLE ANCHOR WIND LOAD (PSF)								
POST HEIGHT (IN.)	POST SPACING (IN.)							
	36	42	48	54	60	66	72	78
36	43.59	37.36	32.69	29.06	26.15	23.78	21.80	20.12
42	32.03	27.45	24.02	21.35	19.22	17.47	16.01	14.78
48	24.52	21.02	18.39	16.35	14.71	13.37	12.26	11.32
54	19.37	16.61	14.53	12.92	11.62	10.57	9.69	8.94
60	15.69	13.45	11.77	10.46	9.42	8.56	7.85	7.24

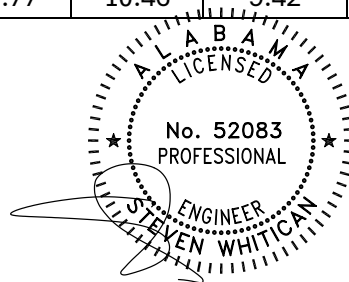

Project Description: Glass Warehouse LLC / FutureGlass – Fabrikasi Posted Glass Railing System	Date: January 30, 2025	Customer: Glass Warehouse LLC / FutureGlass	
	Engineer: SH	Project #: EEV-24-0628	
	PER: 9361	Page #: Page 6 of 39	



Table 8: Anchor Types A & D

ALLOWABLE ANCHOR WIND LOAD (PSF)								
POST HEIGHT (IN.)	POST SPACING (IN.)							
	36	42	48	54	60	66	72	78
36	48.44	41.52	36.33	32.30	29.07	26.42	24.22	22.36
42	35.59	30.51	26.69	23.73	21.36	19.41	17.80	16.43
48	27.25	23.36	20.44	18.17	16.35	14.86	13.63	12.58
54	21.53	18.46	16.15	14.35	12.92	11.74	10.77	9.94
60	17.44	14.95	13.08	11.63	10.46	9.51	8.72	8.05

Table 9: Anchor Types B, E, & H

ALLOWABLE ANCHOR WIND LOAD (PSF)								
POST HEIGHT (IN.)	POST SPACING (IN.)							
	36	42	48	54	60	66	72	78
36	56.70	48.60	42.53	37.80	34.02	30.93	28.35	26.17
42	41.66	35.71	31.24	27.77	24.99	22.72	20.83	19.23
48	31.89	27.34	23.92	21.26	19.14	17.40	15.95	14.72
54	25.20	21.60	18.90	16.80	15.12	13.75	12.60	11.63
60	20.41	17.50	15.31	13.61	12.25	11.13	10.21	9.42

Table 10: Anchor Types C, F, & I

ALLOWABLE ANCHOR WIND LOAD (PSF)								
POST HEIGHT (IN.)	POST SPACING (IN.)							
	36	42	48	54	60	66	72	78
36	70.44	60.38	52.83	46.96	42.26	38.42	35.22	32.51
42	51.75	44.36	38.81	34.50	31.05	28.23	25.88	23.88
48	39.62	33.96	29.72	26.41	23.77	21.61	19.81	18.29
54	31.31	26.83	23.48	20.87	18.78	17.08	15.65	14.45
60	25.36	21.74	19.02	16.91	15.21	13.83	12.68	11.70

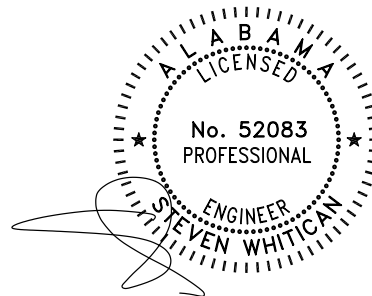

Project Description: Glass Warehouse LLC / FutureGlass – Fabrikasi Posted Glass Railing System	Date: January 30, 2025	Customer: Glass Warehouse LLC / FutureGlass	
	Engineer: SH	Project #: EEV-24-0628	
		PER: 9361	Page #: Page 7 of 39



Glass Strength

Table 11: Glass properties extracted from ASTM E1300

Glass Properties				
Glass types	Modulus of rupture, psi	All. Bending Stress, psi	All. Compressive Stress, psi	All. Glass Stress per ASTM E1300, psi
Tempered	24000	6000	6000	9600
Heat Strengthened	12000	3000	3000	5300
Annealed	6000	1500	1500	2900

Table 12: 5/16" Monolithic Tempered Glass Allowable Wind Loads

Allowable Wind Load Table (PSF) - 5/16" Tempered Glass								
Glass Height (in.)	Post Spacing (in.)							
	36.0	42.0	48.0	54.0	60.0	66.0	72.0	78.0
36.0	121.26	89.09	68.21	-	-	-	-	-
42.0	121.26	89.09	68.21	53.90	-	-	-	-
48.0	121.26	89.09	68.21	53.90	43.66	-	-	-
54.0	121.26	89.09	68.21	53.90	43.66	36.08	-	-
60.0	121.26	89.09	68.21	53.90	43.66	36.08	30.32	-

Table 13: 3/8" Monolithic Tempered Glass Allowable Wind Loads

Allowable Wind Load Table (PSF) - 3/8" Tempered Glass								
Glass Height (in.)	Post Spacing (in.)							
	36.0	42.0	48.0	54.0	60.0	66.0	72.0	78.0
36.0	179.24	131.68	100.82	79.66	64.52	53.33	44.81	-
42.0	179.24	131.68	100.82	79.66	64.52	53.33	44.81	38.18
48.0	179.24	131.68	100.82	79.66	64.52	53.33	44.81	38.18
54.0	179.24	131.68	100.82	79.66	64.52	53.33	44.81	38.18
60.0	179.24	131.68	100.82	79.66	64.52	53.33	44.81	38.18

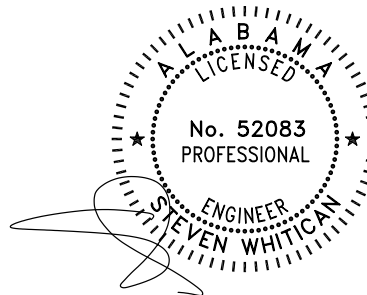

Project Description: Glass Warehouse LLC / FutureGlass – Fabrikasi Posted Glass Railing System	Date: January 30, 2025	Customer: Glass Warehouse LLC / FutureGlass	
	Engineer: SH	Project #: EEV-24-0628	
	PER: 9361	Page #: Page 8 of 39	



Table 14: 1/2" Monolithic Tempered Glass Allowable Wind Loads

Allowable Wind Load Table (PSF) - 1/2" Tempered Glass								
Glass Height (in.)	Post Spacing (in.)							
	36.0	42.0	48.0	54.0	60.0	66.0	72.0	78.0
36.0	312.89	229.88	176.00	139.06	112.64	93.09	78.22	66.65
42.0	312.89	229.88	176.00	139.06	112.64	93.09	78.22	66.65
48.0	312.89	229.88	176.00	139.06	112.64	93.09	78.22	66.65
54.0	312.89	229.88	176.00	139.06	112.64	93.09	78.22	66.65
60.0	312.89	229.88	176.00	139.06	112.64	93.09	78.22	66.65

Table 15: 7/16" Laminated Glass: 3/16" Tempered Glass – 0.060" PVB – 3/16" Tempered Glass

Allowable Wind Load Table (PSF)								
Glass Height (in.)	Post Spacing (in.)							
	36.0	42.0	48.0	54.0	60.0	66.0	72.0	78.0
36.0	136.76	108.18	88.40	73.92	-	-	-	-
42.0	136.76	108.18	88.40	73.92	62.87	54.18	-	-
48.0	136.76	108.18	88.40	73.92	62.87	54.18	47.19	41.46
54.0	136.76	108.18	88.40	73.92	62.87	54.18	47.19	41.46
60.0	136.76	108.18	88.40	73.92	62.87	54.18	47.19	41.46

Table 16: 7/16" Laminated Glass: 3/16" Tempered Glass – 0.060" SentryGlas – 3/16" Tempered Glass

Allowable Wind Load Table (PSF)								
Glass Height (in.)	Post Spacing (in.)							
	36.0	42.0	48.0	54.0	60.0	66.0	72.0	78.0
36.0	234.71	175.24	135.62	107.97	87.93	72.97	61.51	52.54
42.0	234.71	175.24	135.62	107.97	87.93	72.97	61.51	52.54
48.0	234.71	175.24	135.62	107.97	87.93	72.97	61.51	52.54
54.0	234.71	175.24	135.62	107.97	87.93	72.97	61.51	52.54
60.0	234.71	175.24	135.62	107.97	87.93	72.97	61.51	52.54

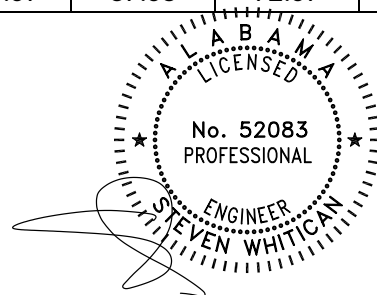

Project Description: Glass Warehouse LLC / FutureGlass – Fabrikasi Posted Glass Railing System	Date: January 30, 2025	Customer: Glass Warehouse LLC / FutureGlass	
	Engineer: SH	Project #: EEV-24-0628	
	PER: 9361	Page #: Page 9 of 39	



YOU ENVISION IT – WE ENGINEER IT

1900 NE Miami Ct., Ste. 2-15
 Miami, FL 33132
 TEL: 954.399-8478 | FAX: 954.744.4738
 WEB: www.buildingdrops.com

Table 17: 9/16" Laminated Glass: 1/4" Tempered Glass – 0.060" PVB – 1/4" Tempered Glass

Allowable Wind Load Table (PSF)								
Glass Height (in.)	Post Spacing (in.)							
	36.0	42.0	48.0	54.0	60.0	66.0	72.0	78.0
36.0	188.09	147.78	120.28	100.39	85.34	73.58	64.16	-
42.0	188.09	147.78	120.28	100.39	85.34	73.58	64.16	56.47
48.0	188.09	147.78	120.28	100.39	85.34	73.58	64.16	56.47
54.0	188.09	147.78	120.28	100.39	85.34	73.58	64.16	56.47
60.0	188.09	147.78	120.28	100.39	85.34	73.58	64.16	56.47

Table 18: 9/16" Laminated Glass: 1/4" Tempered Glass – 0.060" SentryGlas – 1/4" Tempered Glass

Allowable Wind Load Table (PSF)								
Glass Height (in.)	Post Spacing (in.)							
	36.0	42.0	48.0	54.0	60.0	66.0	72.0	78.0
36.0	326.39	244.36	189.49	151.07	123.16	102.29	86.27	73.73
42.0	326.39	244.36	189.49	151.07	123.16	102.29	86.27	73.73
48.0	326.39	244.36	189.49	151.07	123.16	102.29	86.27	73.73
54.0	326.39	244.36	189.49	151.07	123.16	102.29	86.27	73.73
60.0	326.39	244.36	189.49	151.07	123.16	102.29	86.27	73.73

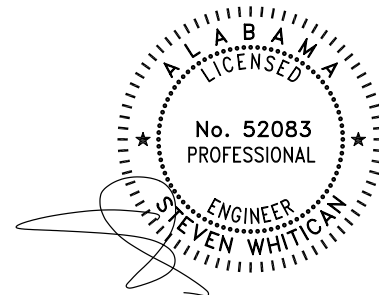

Project Description: Glass Warehouse LLC / FutureGlass – Fabrikasi Posted Glass Railing System	Date: January 30, 2025	Customer: Glass Warehouse LLC / FutureGlass	
	Engineer: SH	Project #: EEV-24-0628	
	PER: 9361	Page #: Page 10 of 39	

Cap Rail Allowable Span Calculations

Guard applications require a top rail or handrail. The rail shall have adequate strength to support the live load of 200 lb concentrated or 50 plf distributed load assuming the failure of one glass light at the location of the loading. No US building codes or adopted standards define the limit state of the guard cap rail for this condition. IBC 2407.1.2 states “shall be otherwise supported to remain in place should one baluster fail.” There is no additional explanation in the IBC as to how this is to be determined. ICC Acceptance Criteria 439 was adopted to provide a methodology for determining if a glass balustrade guard meets the requirements of IBC 2407. ICC AC 439 requires the rail to be capable of supporting a 334# load (SF = 1.67 for 200# load) with no more than 12” deflection, yielding or other damage is permitted since the loss of a glass light will necessitate guard repairs. For light failure only the horizontal load case applies for laminated glass.

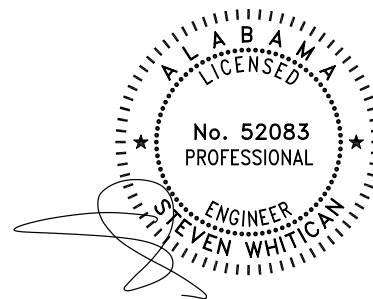
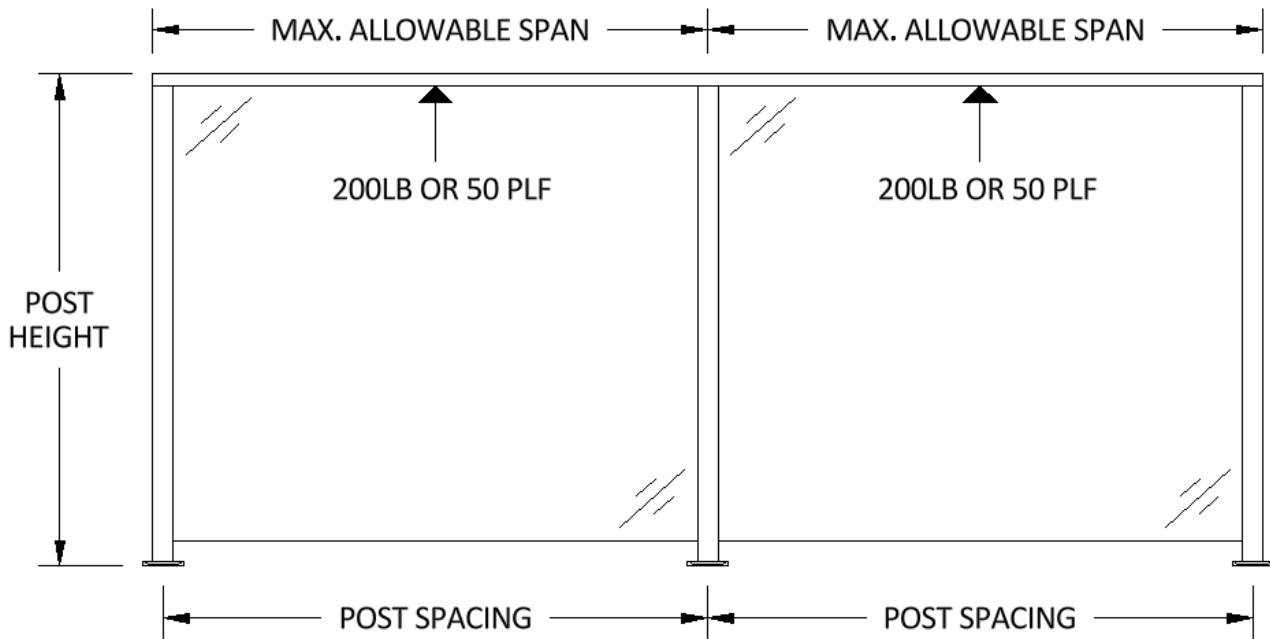

Project Description: Glass Warehouse LLC / FutureGlass – Fabrikasi Posted Glass Railing System	Date: January 30, 2025	Customer: Glass Warehouse LLC / FutureGlass	
	Engineer: SH	Project #: EEV-24-0628	
	PER: 9361	Page #: Page 11 of 39	

GSW005/006 Top Rail Allowable Span

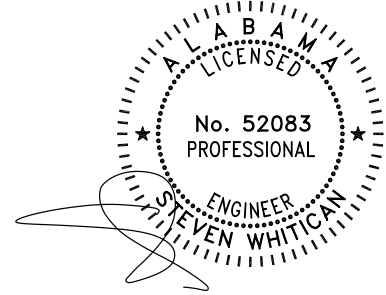

Top Rail = GSW 005/006

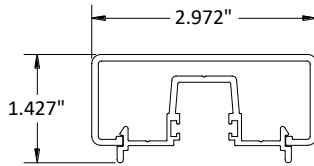

- Area = 0.8653 in²
- Perim. = 22.1741 in
- Ixx = 0.1840 in⁴
- Iyy = 0.8134 in⁴
- rx = 0.4611 in
- ry = 0.9695 in
- Cxx = 1.4862 in
- Cyy = 0.8367 in
- Sxx = 0.2199 in³
- Syy = 0.5473 in³
- t = 0.087 in
- w = 0.8349 in

Material = 6063-T5

- Fy = 21 ksi
- Fu = 27 ksi

$$M_n = 1.25 S_e F_y$$

- M_{n Vertical Load} = 5.7727 k-in
- M_{n Horizontal Load} = 14.3667 k-in

Simply Supported Rail

$$M_w = wL^2/10$$

- L_{uniform Vert.} = 117.70 in
- L_{uniform Horiz.} = 185.69 in

$$M_c = PL/5$$

- L_{concentrated vert.} = 144.32 in
- L_{concentrated horiz.} = 359.17 in

Allowable Rail Span = 117 in = 9.75 ft

Project Description: Glass Warehouse LLC / FutureGlass – Fabrikasi Posted Glass Railing System	Date: January 30, 2025	Customer: Glass Warehouse LLC / FutureGlass	
		Project #: EEV-24-0628	
	Engineer: SH	PER: 9361	Page #: Page 12 of 39



YOU ENVISION IT – WE ENGINEER IT

1900 NE Miami Ct., Ste. 2-15
Miami, FL 33132
TEL: 954.399-8478 | FAX: 954.744.4738
WEB: www.buildingdrops.com

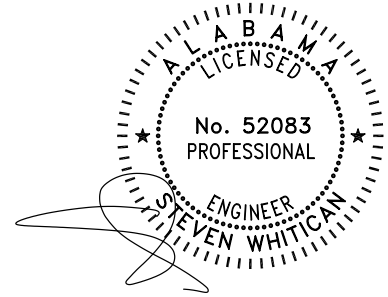

APPENDIX

Project Description: Glass Warehouse LLC / FutureGlass – Fabrikasi Posted Glass Railing System	Date: January 30, 2025	Customer: Glass Warehouse LLC / FutureGlass	
		Project #: EEV-24-0628	
	Engineer: SH	PER: 9361	Page #: Page 13 of 39



Aluminum Post

Post Name = Intermediate Post
 Post Material = 6063-T5
 Modulus of Elasticity = 10100000 lbs/in²
 $F_y = 21000$ lbs/in²
 $I_{xx} = 0.5762$ in⁴
 $I_{yy} = 0.3996$ in⁴
 $S_{xx} = 0.5854$ in³
 $S_{yy} = 0.4060$ in³
 $Z_{xx} = 0.7439$ in³
 $Z_{yy} = 0.5640$ in³
 Allowable Post Moment, $M_a = 15621.9$ lbs-in

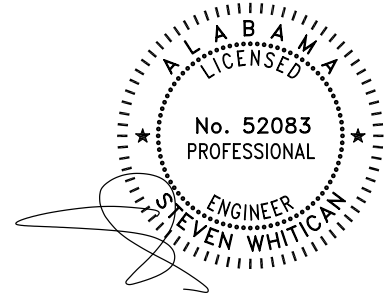

Max. Height Due to 200lb Concentrated Load at Top of Post

$M_{200} = 200 * H$
 Max. Post Height = 78.11 in

Max. Heights Due to 50 lb/ft Load at Various Post Spacings

$M_{50plf} = 50/12 * H * S$

Max. Height (in.)							
Post Spacing (in.)							
36	42	48	54	60	66	72	78
104.15	89.27	78.11	69.43	62.49	56.81	52.07	48.07

Max. Allowable Height

Max. Allowable Height (in.)							
Post Spacing (in.)							
36	42	48	54	60	66	72	78
78.11	78.11	78.11	69.43	62.49	56.81	52.07	48.07

Allowable Wind Load Due to Allowable Moment of Post

$W = (144 * M_a) / (0.55 * S * H^2)$

Allowable Wind Load (PSF)								
Post Height (in)	Post Spacing (in.)							
	36	42	48	54	60	66	72	78
36	87.66	75.14	65.75	58.44	52.60	47.82	43.83	40.46
42	64.41	55.21	48.31	42.94	38.64	35.13	32.20	29.73
48	49.31	42.27	36.98	32.87	29.59	26.90	24.66	22.76
54	38.96	33.40	29.22	25.97	23.38	21.25	-	-
60	31.56	27.05	23.67	21.04	18.94	-	-	-

Project Description: Glass Warehouse LLC / FutureGlass – Fabrikasi Posted Glass Railing System	Date: January 30, 2025	Customer: Glass Warehouse LLC / FutureGlass	
	Engineer: SH	Project #: EEV-24-0628	
	PER: 9361	Page #: Page 14 of 39	



YOU ENVISION IT – WE ENGINEER IT

1900 NE Miami Ct., Ste. 2-15
 Miami, FL 33132
 TEL: 954.399-8478 | FAX: 954.744.4738
 WEB: www.buildingdrops.com

Aluminum Post

PostName = End Post
 Post Material = 6063-T5
 Modulus of Elasticity = 10100000 lbs/in²
 F_y = 21000 lbs/in²
 I_{xx} = 0.5587 in⁴
 I_{yy} = 0.4328 in⁴
 S_{xx} = 0.5676 in³
 S_{yy} = 0.4306 in³
 Z_{xx} = 0.7080 in³
 Z_{yy} = 0.5838 in³
 Allowable Post Moment, M_a = 14868.0 lbs-in

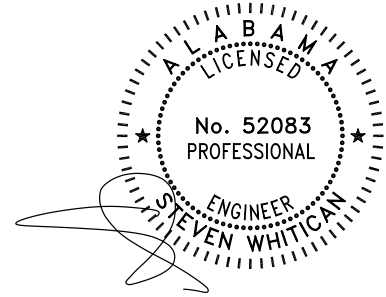

Max. Height Due to 200lb Concentrated Load at Top of Post

M₂₀₀ = 200 * H
 Max. Post Height = 74.34 in

Max. Heights Due to 50 lb/ft Load at Various Post Spacings

M_{50aft} = 50/12 * H * S

Max. Height (in.)							
Trib. Post Spacing (in.)							
18	21	24	27	30	33	36	39
198.24	169.92	148.68	132.16	118.94	108.13	99.12	91.50

Max. Allowable Height

Max. Allowable Height (in.)							
Trib. Post Spacing (in.)							
18	21	24	27	30	33	36	39
74.34	74.34	74.34	74.34	74.34	74.34	74.34	74.34

Allowable Wind Load Due to Allowable Moment of Post

W = (144 * M_a) / (0.55 * S * H²)

Allowable Wind Load (PSF)								
Post Height (in)	Trib. Post Spacing (in.)							
	18	21	24	27	30	33	36	39
36	166.87	143.03	125.15	111.25	100.12	91.02	83.43	77.02
42	122.60	105.08	91.95	81.73	73.56	66.87	61.30	56.58
48	93.86	80.45	70.40	62.58	56.32	51.20	46.93	43.32
54	74.16	63.57	55.62	49.44	44.50	40.45	37.08	34.23
60	60.07	51.49	45.05	40.05	36.04	32.77	30.04	27.73

Project Description: Glass Warehouse LLC / FutureGlass – Fabrikasi Posted Glass Railing System	Date: January 30, 2025	Customer: Glass Warehouse LLC / FutureGlass	
	Engineer: SH	Project #: EEV-24-0628	
	PER: 9361	Page #: Page 15 of 39	



YOU ENVISION IT – WE ENGINEER IT

1900 NE Miami Ct., Ste. 2-15
 Miami, FL 33132
 TEL: 954.399-8478 | FAX: 954.744.4738
 WEB: www.buildingdrops.com

Aluminum Post

Post Name = 90° Post
 Post Material = 6063-T5
 Modulus of Elasticity = 10100000 lbs/in²
 F_y = 21000 lbs/in²
 I_{xx} = 0.4294 in⁴
 I_{yy} = 0.4294 in⁴
 S_{xx} = 0.4283 in³
 S_{yy} = 0.4283 in³
 Z_{xx} = 0.5664 in³
 Z_{yy} = 0.5664 in³
 Allowable Post Moment, M_a = 11894.4 lbs-in

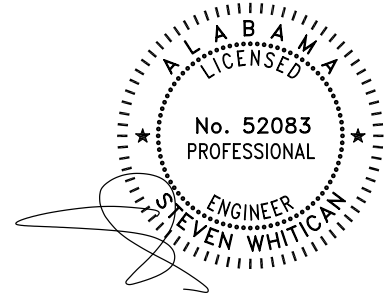

Max. Height Due to 200lb Concentrated Load at Top of Post

M₂₀₀ = 200 * H
 Max. Post Height = 59.47 in

Max. Heights Due to 50 lb/ft Load at Various Post Spacings

M_{50pft} = 50/12 * H * S

Max. Height (in.)							
Trib. Post Spacing (in.)							
18	21	24	27	30	33	36	39
158.59	135.94	118.94	105.73	95.16	86.50	79.30	73.20

Max. Allowable Height

Max. Allowable Height (in.)							
Trib. Post Spacing (in.)							
18	21	24	27	30	33	36	39
59.47	59.47	59.47	59.47	59.47	59.47	59.47	59.47

Allowable Wind Load Due to Allowable Moment of Post

W = (144 * M_a) / (0.55 * S * H²)

Allowable Wind Load (PSF)								
Post Height (in)	Trib. Post Spacing (in.)							
	18	21	24	27	30	33	36	39
36	133.49	114.42	100.12	89.00	80.10	72.82	66.75	61.61
42	98.08	84.07	73.56	65.39	58.85	53.50	49.04	45.27
48	75.09	64.36	56.32	50.06	45.05	40.96	37.55	34.66
54	59.33	50.86	44.50	39.55	35.60	32.36	29.67	27.38
60	-	-	-	-	-	-	-	-

Project Description: Glass Warehouse LLC / FutureGlass – Fabrikasi Posted Glass Railing System	Date: January 30, 2025	Customer: Glass Warehouse LLC / FutureGlass	
	Engineer: SH	Project #: EEV-24-0628	
	PER: 9361	Page #: Page 16 of 39	

5/16" Lag Screw into Mixed Maple-Southern Pine w/ 0 in. of Gap Space.

Base Plate Installation

Calculations herein are performed in accordance with the National Design Specification for Wood Construction - 2018, Chapter 12.3 and Technical Report 12- General Dowel Equations for Calculating Lateral Connection Values, published by the American Wood Council

Wood Screw Type=	5/16"	Lag Screw
Wood Screw Length=	2.00	in
Wood Screw Embedment=	1.50	in
Wood Screw Thread Length=	1.50	in
D =	0.313	in , Dowel Diameter
D _m =	0.227	in , Dowel Diameter at max. stress in main member
D _s =	0.227	in , Dowel Diameter at max. stress in side member
F _b =	60,000	psi , Dowel bending strength

Wood Screw Withdrawal Calculations

Substrate:	Mixed Maple-Southern Pine
Tabulated withdrawal design value:	W = 306 lbs
Penetration Factor:	C _p = 1.50 in
Duration Factor:	C _d = 1.60

Withdrawal Allowable (W') = 734.0 lbs

Wood Screw Lateral Calculations - Solid Main Member - Solid Side Member

Substrate (Main Member):	Mixed Maple-Southern Pine
Frame (Side Member):	Aluminum 6063-T6
Cantilever Distance:	0 in , Frame hollow space+ shim
ℓ _m =	1.500 in , Main member dowel bearing length
ℓ _s =	0.438 in , Side member dowel bearing length
F _{em} =	4,586 psi , Main member dowel bearing strength
F _{es} =	35,000 psi , Side member dowel bearing strength
q _m =	1,041 lbs/in , Main member dowel bearing resistance = F _{em} D _m
q _s =	7,945 lbs/in , Side member dowel bearing resistance = F _{es} D _s
M _m =	116.97 in-lbs , Main member dowel moment resistance = F _b (D _m ³ /6)
M _s =	116.97 in-lbs , Side member dowel moment resistance = F _b (D _s ³ /6)
θ =	90 degrees , Maximum angle of load to grain (0° ≤ θ ≤ 90°) for any member in a connection
K _θ =	1.25
K _D =	2.770

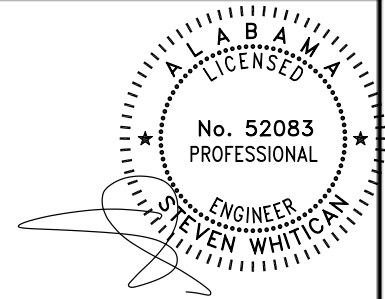

Project Description: Glass Warehouse LLC / FutureGlass – Fabrikasi Posted Glass Railing System	Date: January 30, 2025	Customer: Glass Warehouse LLC / FutureGlass	
	Engineer: SH	Project #: EEV-24-0628	
	PER: 9361	Page #: Page 17 of 39	



YOU ENVISION IT – WE ENGINEER IT

1900 NE Miami Ct., Ste. 2-15
 Miami, FL 33132
 TEL: 954.399-8478 | FAX: 954.744.4738
 WEB: www.buildingdrops.com

5/16" Lag Screw into Mixed Maple-Southern Pine w/ 0 in. of Gap Space.
Base Plate Installation

Yield Limit Equations per Table 11.3.1A of ANSI/AWC NDS-2018 and Table 1-1 of Technical Report 12 from AWC

		Single Shear		Double Shear		
Mode I _m	Z _F	1561.52	lbs	1561.52	lbs	, Main Member Bearing , Reduction Term
				5.00		
Mode I_m	Z_F	312.30	lbs	312.30	lbs	
Mode I _s	Z _F	3440.19	lbs	6880.37	lbs	, Side Member Bearing , Reduction Term
				5.00		
Mode I_s	Z_F	688.04	lbs	1376.07	lbs	
Mode II	Z _{IF}	807.79	lbs			, Side and Main Member Bearing
	A =	0.0003				
	B =	0.967				
	C =	-957.97				
				4.50		, Reduction Term
Mode II	Z_{IF}	179.51	lbs			
Mode III _m	Z _{IF}	724.57	lbs			, Main Member Bearing and Dowel Yielding in the Side Member
	A =	0.0003				
	B =	0.750				
	C =	-702.54				
				4.00		, Reduction Term
Mode III_m	Z_{IF}	181.14	lbs			
Mode III _s	Z _{IF}	788.97	lbs	1577.93	lbs	, Side Member Bearing and Dowel Yielding in the Main Member
	A =	0.0005				
	B =	0.217				
	C =	-489.37				
				4.00		, Reduction Term
Mode III_s	Z_{IF}	197.24	lbs	394.48	lbs	
Mode IV	Z _{IF}	656.24	lbs	1312.47	lbs	, Dowel Yielding in the Side and Main Member
	A =	0.0005				
	B =	0.000				
	C =	-233.94				
				4.00		, Reduction Term
Mode IV	Z_{IF}	164.06	lbs	328.12	lbs	

C_d = 1.6 , Load Duration
 C_p = 1.000 , Penetration Factor

Single Lateral Allowable (Z'_s) = 262.495 lbs

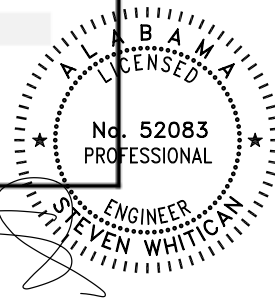

Project Description: Glass Warehouse LLC / FutureGlass – Fabrikasi Posted Glass Railing System	Date: January 30, 2025	Customer: Glass Warehouse LLC / FutureGlass	
	Engineer: SH	Project #: EEV-24-0628	
	PER: 9361	Page #: Page 18 of 39	

3/8" Lag Screw into Mixed Maple-Southern Pine w/ 0 in. of Gap Space.

Base Plate Installation

Calculations herein are performed in accordance with the National Design Specification for Wood Construction - 2018, Chapter 12.3 and Technical Report 12- General Dowel Equations for Calculating Lateral Connection Values, published by the American Wood Council

Wood Screw Type=	3/8"	Lag Screw
Wood Screw Length=	2.00	in
Wood Screw Embedment=	1.50	in
Wood Screw Thread Length=	1.50	in
D =	0.375	in , Dowel Diameter
D _m =	0.265	in , Dowel Diameter at max. stress in main member
D _s =	0.265	in , Dowel Diameter at max. stress in side member
F _b =	45,000	psi , Dowel bending strength

Wood Screw Withdrawal Calculations

Substrate:	Mixed Maple-Southern Pine
Tabulated withdrawal design value:	W = 351 lbs
Penetration Factor:	C _p = 1.50 in
Duration Factor:	C _d = 1.60
Withdrawal Allowable (W') = 842.0 lbs	

Wood Screw Lateral Calculations - Solid Main Member - Solid Side Member

Substrate (Main Member):	Mixed Maple-Southern Pine
Frame (Side Member):	Aluminum 6063-T6
Cantilever Distance:	0 in , Frame hollow space+ shim
ℓ _m =	1.500 in , Main member dowel bearing length
ℓ _s =	0.438 in , Side member dowel bearing length
F _{em} =	4,186 psi , Main member dowel bearing strength
F _{es} =	35,000 psi , Side member dowel bearing strength
q _m =	1,109 lbs/in , Main member dowel bearing resistance = F _{em} D _m
q _s =	9,275 lbs/in , Side member dowel bearing resistance = F _{es} D _s
M _m =	139.57 in-lbs , Main member dowel moment resistance = F _b (D _m ³ /6)
M _s =	139.57 in-lbs , Side member dowel moment resistance = F _b (D _s ³ /6)
θ =	90 degrees , Maximum angle of load to grain (0° ≤ θ ≤ 90°) for any member in a connection
K _θ =	1.25
K _D =	N/A

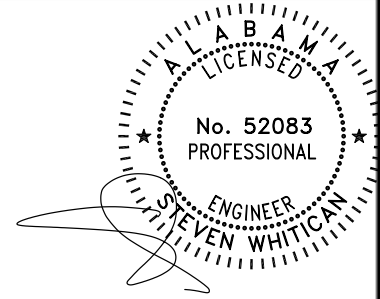

Project Description: Glass Warehouse LLC / FutureGlass – Fabrikasi Posted Glass Railing System	Date: January 30, 2025	Customer: Glass Warehouse LLC / FutureGlass	
	Engineer: SH	Project #: EEV-24-0628	
	PER: 9361	Page #: Page 19 of 39	

**3/8" Lag Screw into Mixed Maple-Southern Pine w/ 0 in. of Gap Space.
 Base Plate Installation**

Yield Limit Equations per Table 11.3.1A of ANSI/AWC NDS-2018 and Table 1-1 of Technical Report 12 from AWC

		Single Shear		Double Shear		
Mode I _m	Z _r =	1664.09	lbs	1664.09	lbs	, Main Member Bearing , Reduction Term
Mode I_m	Z_r=	332.82	lbs	332.82	lbs	
Mode I _s	Z _r =	4016.08	lbs	8032.15	lbs	, Side Member Bearing , Reduction Term
Mode I_s	Z_r=	803.22	lbs	1606.43	lbs	
Mode II	Z _r =	889.11	lbs			, Side and Main Member Bearing
	A =	0.0003				
	B =	0.967				
	C =	-1058.77				
				4.50		, Reduction Term
Mode II	Z_r=	197.58	lbs			
Mode III _m	Z _{ri} =	787.33	lbs			, Main Member Bearing and Dowel Yielding in the Side Member
	A =	0.0003				
	B =	0.750				
	C =	-763.61				
				4.00		, Reduction Term
Mode III_m	Z_{ri}=	196.83	lbs			
Mode III _s	Z _{ri} =	898.07	lbs	1786.14	lbs	, Side Member Bearing and Dowel Yielding in the Main Member
	A =	0.0005				
	B =	0.217				
	C =	-574.31				
				4.00		, Reduction Term
Mode III_s	Z_{ri}=	223.27	lbs	446.54	lbs	
Mode IV	Z _{ri} =	743.77	lbs	1487.54	lbs	, Dowel Yielding in the Side and Main Member
	A =	0.0005				
	B =	0.000				
	C =	-279.14				
				4.00		, Reduction Term
Mode IV	Z_{ri}=	185.94	lbs	371.89	lbs	

C_d = 1.6 , Load Duration
 C_p = 1.000 , Penetration Factor

Single Lateral Allowable (Z'_r) = 297.508 lbs

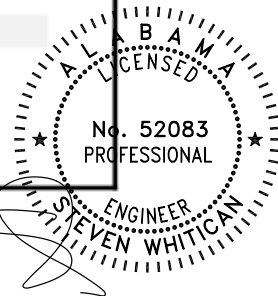

Project Description: Glass Warehouse LLC / FutureGlass – Fabrikasi Posted Glass Railing System	Date: January 30, 2025	Customer: Glass Warehouse LLC / FutureGlass	
	Engineer: SH	Project #: EEV-24-0628	
	PER: 9361	Page #: Page 20 of 39	

1/2" Lag Screw into Mixed Maple-Southern Pine w/0 in. of Gap Space.

Base Plate Installation

Calculations herein are performed in accordance with the National Design Specification for Wood Construction - 2018, Chapter 12.3 and Technical Report 12- General Dowel Equations for Calculating Lateral Connection Values, published by the American Wood Council

Wood Screw Type=	1/2"	Lag Screw
Wood Screw Length=	2.00	in
Wood Screw Embedment=	1.50	in
Wood Screw Thread Length=	1.50	in
D =	0.500	in , Dowel Diameter
D _m =	0.371	in , Dowel Diameter at max. stress in main member
D _s =	0.371	in , Dowel Diameter at max. stress in side member
F _b =	45,000	psi , Dowel bending strength

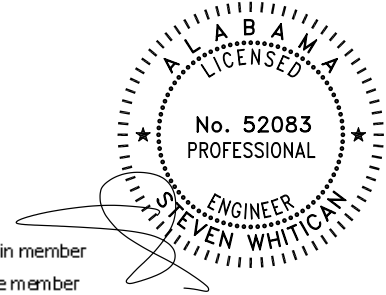

Wood Screw Withdrawal Calculations

Substrate:	Mixed Maple-Southern Pine
Tabulated withdrawal design value:	W = 436 lbs
Penetration Factor:	C _p = 1.50 in
Duration Factor:	C _d = 1.60

Withdrawal Allowable (W') = 1046.0 lbs

Wood Screw Lateral Calculations - Solid Main Member - Solid Side Member

Substrate (Main Member):	Mixed Maple-Southern Pine
Frame (Side Member):	Aluminum 6063-T6
Cantilever Distance:	0 in , Frame hollow space+ shim
ℓ _m =	1.500 in , Main member dowel bearing length
ℓ _s =	0.438 in , Side member dowel bearing length
F _{em} =	3,626 psi , Main member dowel bearing strength
F _{es} =	35,000 psi , Side member dowel bearing strength
q _m =	1,345 lbs/in , Main member dowel bearing resistance = F _{em} D _m
q _s =	12,985 lbs/in , Side member dowel bearing resistance = F _{es} D _s
M _m =	382.99 in-lbs , Main member dowel moment resistance = F _b (D _m ³ /6)
M _s =	382.99 in-lbs , Side member dowel moment resistance = F _b (D _s ³ /6)
θ =	90 degrees , Maximum angle of load to grain (0° ≤ θ ≤ 90°) for any member in a connection
K _θ =	1.25
K _D =	N/A

Project Description: Glass Warehouse LLC / FutureGlass – Fabrikasi Posted Glass Railing System	Date: January 30, 2025	Customer: Glass Warehouse LLC / FutureGlass	
		Project #: EEV-24-0628	
	Engineer: SH	PER: 9361	Page #: Page 21 of 39

1/2" Lag Screw into Mixed Maple-Southern Pine w/ 0 in. of Gap Space.
Base Plate Installation

Yield Limit Equations per Table 11.3.1A of ANSI/AWC NDS-2018 and Table 1-1 of Technical Report 12 from AWC

		Single Shear		Double Shear		
Mode I _m	Z _F	2017.60	lbs	2017.60	lbs	, Main Member Bearing
				5.00		, Reduction Term
Mode I_m	Z_F	403.52	lbs	403.52	lbs	
Mode I _s	Z _F	5622.51	lbs	11245.01	lbs	, Side Member Bearing
				5.00		, Reduction Term
Mode I_s	Z_F	1124.50	lbs	2249.00	lbs	
Mode II	Z _{IF}	1137.81	lbs			, Side and Main Member Bearing
	A =	0.0002				
	B =	0.967				
	C =	-1365.24				
				4.50		, Reduction Term
Mode II	Z_{IF}	252.85	lbs			
Mode III _m	Z _{IF}	1134.44	lbs			, Main Member Bearing and Dowel
	A =	0.0002				Yielding in the Side Member
	B =	0.750				
	C =	-1139.59				
				4.00		, Reduction Term
Mode III_m	Z_{IF}	283.61	lbs			
Mode III _s	Z _{IF}	1339.58	lbs	2679.16	lbs	, Side Member Bearing and Dowel
	A =	0.0004				Yielding in the Main Member
	B =	0.217				
	C =	-991.62				
				4.00		, Reduction Term
Mode III_s	Z_{IF}	334.89	lbs	669.79	lbs	
Mode IV	Z _{IF}	1366.44	lbs	2732.88	lbs	, Dowel Yielding in the Side and Main
	A =	0.0004				Member
	B =	0.000				
	C =	-765.97				
				4.00		, Reduction Term
Mode IV	Z_{IF}	341.61	lbs	683.22	lbs	

C_d = 1.6 , Load Duration
 C_p = 1.000 , Penetration Factor

Single Lateral Allowable (Z'_s) = 404.554 lbs

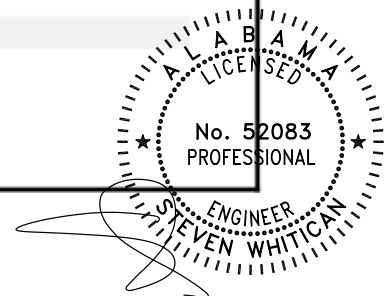

Project Description: Glass Warehouse LLC / FutureGlass – Fabrikasi Posted Glass Railing System	Date: January 30, 2025	Customer: Glass Warehouse LLC / FutureGlass	
	Engineer: SH	Project #: EEV-24-0628	
	PER: 9361	Page #: Page 22 of 39	

E4.3.1 Shear Strength Limited by Tilting and Bearing: 5/16" Self-Tapping Screw

Reference: AISI Cold Formed Steel Specifications, E4.3.1

The nominal shear strength [resistance] per screw, P_{ns} , shall be determined in accordance with this section.

For $t_2/t_1 \leq 1.0$, P_{ns} shall be taken as the smallest of

$P_{ns} = 4.2 (t_2^3 d)^{1/2} F_{u2}$ (Eq. E4.3.1-1)
 $P_{ns} = 2.7 t_1 d F_{u1}$ (Eq. E4.3.1-2)
 $P_{ns} = 2.7 t_2 d F_{u2}$ (Eq. E4.3.1-3)

For $t_2/t_1 \geq 2.5$, P_{ns} shall be taken as the smaller of

$P_{ns} = 2.7 t_1 d F_{u1}$ (Eq. E4.3.1-4)
 $P_{ns} = 2.7 t_2 d F_{u2}$ (Eq. E4.3.1-5)

For $1.0 < t_2/t_1 < 2.5$, P_{ns} shall be calculated by linear interpolation between the above two cases.

Figure 1: Typical Connection Detail

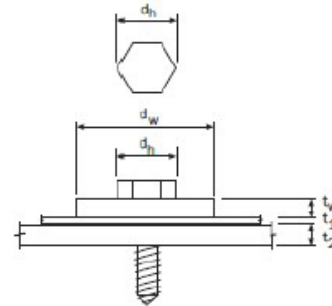

Where,

Nominal screw diameter,

$d = 0.3125$ in.

Thickness of member in contact with screw head,

$t_1 = 0.433$ in.

Thickness of member not in contact with screw head,

$t_2 = 0.125$ in.

Ratio of thickness,

$t_2/t_1 = 0.28868$

Tensile strength of mem. in contact with screw head,

$F_{u1} = 35000$ psi

Tensile strength of mem. not in contact with screw head,

$F_{u2} = 45000$ psi

Eq. E4.3.1-1,

$P_{ns} = 4669.3$ lbs

Eq. E4.3.1-2,

$P_{ns} = 12787$ lbs

Eq. E4.3.1-3,

$P_{ns} = 4746.09$ lbs

Eq. E4.3.1-4,

$P_{ns} = 12787$ lbs

Eq. E4.3.1-5,

$P_{ns} = 4746.09$ lbs

For $t_2/t_1 \leq 1.0$,

$P_{ns} = 4669.3$ lbs

Use This Value

For $t_2/t_1 \geq 2.5$,

$P_{ns} = 4746.09$ lbs

Not Applicable

For $1.0 < t_2/t_1 < 2.5$,

$P_{ns} = 4632.88$ lbs

Not Applicable

Per ASD,

$P_{ns}/\Omega = 1556.43$ lbs, $\Omega = 3$

Per LRFD,

$\Phi P_{ns} = 2334.65$ lbs, $\Phi = 0.5$

Check Shear Capacity of Screw.

5/16" Self Tapping Screw,

$D = 0.3125$ in.

$P_n/\Omega = 1299$ lbs, per AAMATIR A9-14

Check Combined Bending & Shear.

Nom. Diameter, $D = 0.313$ in. $S = 0.0030$ in.³ $A = 0.0767$ in.²

Screw Strength, $F_u = 120.0$ ksi $F_y = 92.0$ ksi $F_v = 27$ ksi $F_b = 45.0$ ksi

Gap Screw, $g = 0.0$

Eff. Cantilever, $d = 0.00$ in.

Allowable Load, $R_n/\Omega = 2070.9$ lbs (based on unity equation)

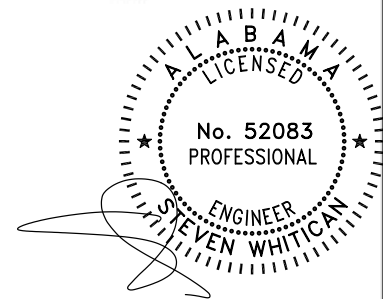

Project Description: Glass Warehouse LLC / FutureGlass – Fabrikasi Posted Glass Railing System	Date: January 30, 2025	Customer: Glass Warehouse LLC / FutureGlass	
	Engineer: SH	Project #: EEV-24-0628	
		PER: 9361	Page #: Page 23 of 39

E4.4.1 Pull-Out Strength: 5/16" Self-Tapping Screw

Reference: AISI Cold Formed Steel Specifications, E4.4.1

E4.4.1 Pull-Out Strength [Resistance]

The nominal pull-out strength [resistance], P_{not} , shall be calculated as follows:
 $P_{not} = 0.85 t_c d F_{u2}$ (Eq. E4.4.1-1)

Same formula is referenced in AAMA TIR A9-14 for thickness of 1/4" or less.

Figure 1: Typical Connection Detail

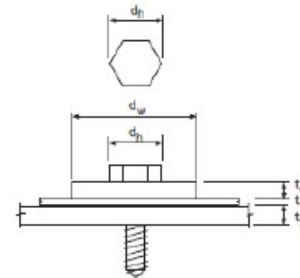

Where,

Nominal screw diameter,

$d = 0.3125$ in.

Thickness of member in contact with screw head,

$t_1 = 0.433$ in.

Thickness of member not in contact with screw head,

$t_2 = 0.125$ in.

Tensile strength of mem. not in contact with screw head,

$F_{u2} = 65000$ psi

Eq. E4.4.1

$P_{not} = 2158.2$ lbs

Per ASD,

$Pns/\Omega = 719.401$ lbs, $\Omega = 3$

Per LRFD,

$\Phi Pns = 1079.1$ lbs, $\Phi = 0.5$

E4.4.2 Pull-Over Strength

Reference: AISI Cold Formed Steel Specifications, E4.4.2

$P_{nov} = 1.5 * t_1 * d_w * F_{u1}$ (Eq. E4.4.2-1)

Where,

Thickness of member in contact with screw head,

$t_1 = 0.433$ in.

Tensile strength of mem. in contact with screw head,

$F_{u1} = 35000$ psi

Effective Pull-over Diameter,

$d_w = 0.625$ in.

Eq. E4.4.2-1

Per ASD,

$Pns/\Omega = 4735.94$ lbs, $\Omega = 3$

Per LRFD,

$\Phi Pns = 7103.91$ lbs, $\Phi = 0.5$

Check Tensile Capacity of Screw.

5/16" Self Tapping Screw,

$D = 0.3125$ in.

$Pn/\Omega = 2517$ lbs, per AAMA TIR A9-14

Design Value

$T = 719.401$ lbs

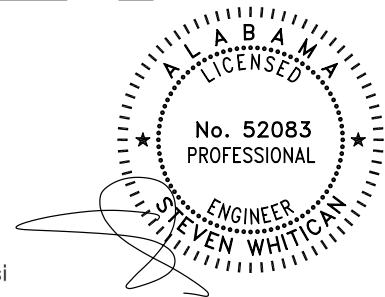

Project Description: Glass Warehouse LLC / FutureGlass – Fabrikasi Posted Glass Railing System	Date: January 30, 2025	Customer: Glass Warehouse LLC / FutureGlass	
	Engineer: SH	Project #: EEV-24-0628	
	PER: 9361	Page #: Page 24 of 39	

E4.3.1 Shear Strength Limited by Tilting and Bearing: 3/8" Self-Tapping Screw

Reference: AISI Cold Formed Steel Specifications, E4.3.1

The nominal shear strength [resistance] per screw, P_{ns} , shall be determined in accordance with this section.

For $t_2/t_1 \leq 1.0$, P_{ns} shall be taken as the smallest of

$P_{ns} = 4.2 (t_2^3 d)^{1/2} F_{u2}$ (Eq. E4.3.1-1)
 $P_{ns} = 2.7 t_1 d F_{u1}$ (Eq. E4.3.1-2)
 $P_{ns} = 2.7 t_2 d F_{u2}$ (Eq. E4.3.1-3)

For $t_2/t_1 \geq 2.5$, P_{ns} shall be taken as the smaller of

$P_{ns} = 2.7 t_1 d F_{u1}$ (Eq. E4.3.1-4)
 $P_{ns} = 2.7 t_2 d F_{u2}$ (Eq. E4.3.1-5)

For $1.0 < t_2/t_1 < 2.5$, P_{ns} shall be calculated by linear interpolation between the above two cases.

Figure 1: Typical Connection Detail

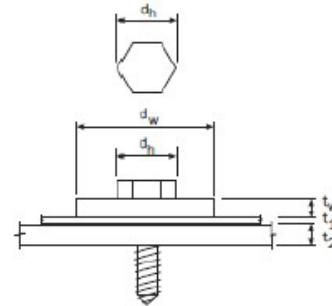

Where,

Nominal screw diameter,

$d = 0.375$ in.

Thickness of member in contact with screw head,

$t_1 = 0.433$ in.

Thickness of member not in contact with screw head,

$t_2 = 0.125$ in.

Ratio of thickness,

$t_2/t_1 = 0.28868$

Tensile strength of mem. in contact with screw head,

$F_{u1} = 35000$ psi

Tensile strength of mem. not in contact with screw head,

$F_{u2} = 45000$ psi

- Eq. E4.3.1-1,
- Eq. E4.3.1-2,
- Eq. E4.3.1-3,
- Eq. E4.3.1-4,
- Eq. E4.3.1-5,

- $P_{ns} = 5114.96$ lbs
- $P_{ns} = 15344.4$ lbs
- $P_{ns} = 5695.31$ lbs
- $P_{ns} = 15344.4$ lbs
- $P_{ns} = 5695.31$ lbs

For $t_2/t_1 \leq 1.0$,

$P_{ns} = 5114.96$ lbs

Use This Value

For $t_2/t_1 \geq 2.5$,

$P_{ns} = 5695.31$ lbs

Not Applicable

For $1.0 < t_2/t_1 < 2.5$,

$P_{ns} = 4839.75$ lbs

Not Applicable

Per ASD,

$P_{ns}/\Omega = 1704.99$ lbs, $\Omega = 3$

Per LRFD,

$\Phi P_{ns} = 2557.48$ lbs, $\Phi = 0.5$

Check Shear Capacity of Screw.

3/8" Self Tapping Screw,

$D = 0.375$ in.

$P_n/\Omega = 1937$ lbs, per AAMA TIR A9-14

Check Combined Bending & Shear.

Nom. Diameter, $D = 0.375$ in. $S = 0.0052$ in.³ $A = 0.11045$ in.²

Screw Strength, $F_u = 120.0$ ksi $F_y = 92.0$ ksi $F_v = 27$ ksi $F_b = 45.0$ ksi

Gap Screw, $g = 0.0$

Eff. Cantilever, $d = 0.00$ in.

Allowable Load, $R_n/\Omega = 2982.1$ lbs (based on unity equation)

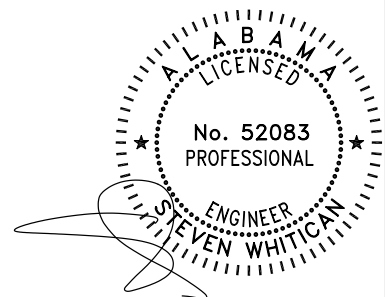

Project Description: Glass Warehouse LLC / FutureGlass – Fabrikasi Posted Glass Railing System	Date: January 30, 2025	Customer: Glass Warehouse LLC / FutureGlass	
	Engineer: SH	Project #: EEV-24-0628	
	PER: 9361	Page #: Page 25 of 39	

E4.4.1 Pull-Out Strength: 3/8" Self-Tapping Screw

Reference: AISI Cold Formed Steel Specifications, E4.4.1

E4.4.1 Pull-Out Strength [Resistance]

The nominal pull-out strength [resistance], P_{not} , shall be calculated as follows:
 $P_{not} = 0.85 t_c d F_{u2}$ (Eq. E4.4.1-1)

Same formula is referenced in AAMA TIR A9-14 for thickness of 1/4" or less.

Figure 1: Typical Connection Detail

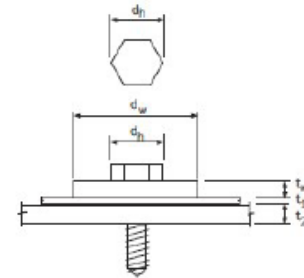

Where,

Nominal screw diameter,

$d = 0.375$ in.

Thickness of member in contact with screw head,

$t_1 = 0.433$ in.

Thickness of member not in contact with screw head,

$t_2 = 0.125$ in.

Tensile strength of mem. not in contact with screw head,

$F_{u2} = 65000$ psi

Eq. E4.4.1

$P_{not} = 2589.84$ lbs

Per ASD,

$P_{ns}/\Omega = 863.281$ lbs, $\Omega = 3$

Per LRFD,

$\Phi P_{ns} = 1294.92$ lbs, $\Phi = 0.5$

E4.4.2 Pull-Over Strength

Reference: AISI Cold Formed Steel Specifications, E4.4.2

$P_{nov} = 1.5 * t_1 * d_w * F_{u1}$ (Eq. E4.4.2-1)

Where,

Thickness of member in contact with screw head,

$t_1 = 0.433$ in.

Tensile strength of mem. in contact with screw head,

$F_{u1} = 35000$ psi

Effective Pullover Diameter,

$d_w = 0.625$ in.

Eq. E4.4.2-1

Per ASD,

$P_{ns}/\Omega = 4735.94$ lbs, $\Omega = 3$

Per LRFD,

$\Phi P_{ns} = 7103.91$ lbs, $\Phi = 0.5$

Check Tensile Capacity of Screw.

3/8" Self Tapping Screw,

$D = 0.375$ in.

$P_n/\Omega = 3719$ lbs, per AAMA TIR A9-14

Design Value

$T = 863.281$ lbs

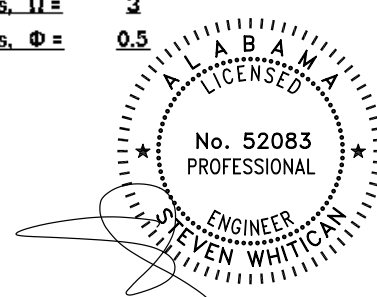

Project Description: Glass Warehouse LLC / FutureGlass – Fabrikasi Posted Glass Railing System	Date: January 30, 2025	Customer: Glass Warehouse LLC / FutureGlass	
	Engineer: SH	Project #: EEV-24-0628	
	PER: 9361	Page #: Page 26 of 39	

E4.3.1 Shear Strength Limited by Tilting and Bearing: 1/2" Self-Tapping Screw

Reference: AISI Cold Formed Steel Specifications, E4.3.1

The nominal shear strength [resistance] per screw, P_{ns} , shall be determined in accordance with this section.

For $t_2/t_1 \leq 1.0$, P_{ns} shall be taken as the smallest of

$P_{ns} = 4.2 (t_2^3 d)^{1/2} F_{u2}$ (Eq. E4.3.1-1)

$P_{ns} = 2.7 t_1 d F_{u1}$ (Eq. E4.3.1-2)

$P_{ns} = 2.7 t_2 d F_{u2}$ (Eq. E4.3.1-3)

For $t_2/t_1 \geq 2.5$, P_{ns} shall be taken as the smaller of

$P_{ns} = 2.7 t_1 d F_{u1}$ (Eq. E4.3.1-4)

$P_{ns} = 2.7 t_2 d F_{u2}$ (Eq. E4.3.1-5)

For $1.0 < t_2/t_1 < 2.5$, P_{ns} shall be calculated by linear interpolation between the above two cases.

Figure 1: Typical Connection Detail

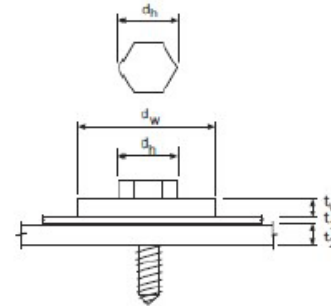

Where,

Nominal screw diameter,

$d = 0.5$ in.

Thickness of member in contact with screw head,

$t_1 = 0.433$ in.

Thickness of member not in contact with screw head,

$t_2 = 0.125$ in.

Ratio of thickness,

$t_2/t_1 = 0.28868$

Tensile strength of mem. in contact with screw head,

$F_{u1} = 35000$ psi

Tensile strength of mem. not in contact with screw head,

$F_{u2} = 45000$ psi

Eq. E4.3.1-1,

$P_{ns} = 5906.25$ lbs

Eq. E4.3.1-2,

$P_{ns} = 20459.3$ lbs

Eq. E4.3.1-3,

$P_{ns} = 7593.75$ lbs

Eq. E4.3.1-4,

$P_{ns} = 20459.3$ lbs

Eq. E4.3.1-5,

$P_{ns} = 7593.75$ lbs

For $t_2/t_1 \leq 1.0$,

$P_{ns} = 5906.25$ lbs

Use This Value

For $t_2/t_1 \geq 2.5$,

$P_{ns} = 7593.75$ lbs

Not Applicable

For $1.0 < t_2/t_1 < 2.5$,

$P_{ns} = 5106.02$ lbs

Not Applicable

Per ASD,

$P_{ns}/\Omega = 1968.75$ lbs, $\Omega = 3$

Per LRFD,

$\Phi P_{ns} = 2953.13$ lbs, $\Phi = 0.5$

Check Shear Capacity of Screw.

1/2" Self Tapping Screw,

$D = 0.5$ in.

$P_n/\Omega = 3581$ lbs, per AAMA TIR A9-14

Check Combined Bending & Shear.

Nom. Diameter, $D = 0.500$ in. $S = 0.0123$ in.³ $A = 0.19635$ in.²

Screw Strength, $F_u = 120.0$ ksi $F_y = 92.0$ ksi $F_v = 27$ ksi $F_b = 45.0$ ksi

Gap Screw, $g = 0.0$

Eff. Cantilever, $d = 0.00$ in.

Allowable Load, $R_n/\Omega = 5301.4$ lbs (based on unity equation)

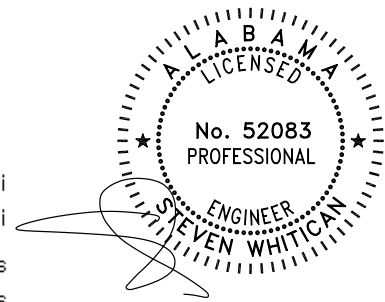

Project Description: Glass Warehouse LLC / FutureGlass – Fabrikasi Posted Glass Railing System	Date: January 30, 2025	Customer: Glass Warehouse LLC / FutureGlass	
	Engineer: SH	Project #: EEV-24-0628	
	PER: 9361	Page #: Page 27 of 39	

E4.4.1 Pull-Out Strength: 1/2" Self-Tapping Screw

Reference: AISI Cold Formed Steel Specifications, E4.4.1

E4.4.1 Pull-Out Strength [Resistance]

The nominal pull-out strength [resistance], P_{not} , shall be calculated as follows:
 $P_{not} = 0.85 t_c d F_{u2}$ (Eq. E4.4.1-1)

Same formula is referenced in AAMA TIR A9-14 for thickness of 1/4" or less.

Figure 1: Typical Connection Detail

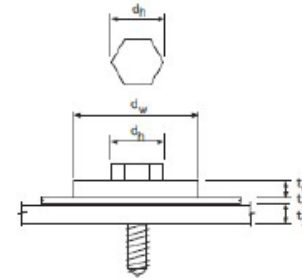

Where,

Nominal screw diameter,

$d = 0.5$ in.

Thickness of member in contact with screw head,

$t_1 = 0.433$ in.

Thickness of member not in contact with screw head,

$t_2 = 0.125$ in.

Tensile strength of mem. not in contact with screw head,

$F_{u2} = 65000$ psi

Eq. E4.4.1

$P_{not} = 3453.13$ lbs

Per ASD,

$Pns/\Omega = 1151.04$ lbs, $\Omega = 3$

Per LRFD,

$\Phi Pns = 1726.56$ lbs, $\Phi = 0.5$

E4.4.2 Pull-Over Strength

Reference: AISI Cold Formed Steel Specifications, E4.4.2

$P_{nov} = 1.5 * t_1 * d_w * F_{u1}$ (Eq. E4.4.2-1)

Where,

Thickness of member in contact with screw head,

$t_1 = 0.433$ in.

Tensile strength of mem. in contact with screw head,

$F_{u1} = 35000$ psi

Effective Pull-over Diameter,

$d_w = 0.625$ in.

Eq. E4.4.2-1

Per ASD,

$Pns/\Omega = 4735.94$ lbs, $\Omega = 3$

Per LRFD,

$\Phi Pns = 7103.91$ lbs, $\Phi = 0.5$

Check Tensile Capacity of Screw.

1/2" Self Tapping Screw,

$D = 0.5$ in.

$P_n/\Omega = 6811$ lbs, per AAMA TIR A9-14

Design Value

$T = 1151.04$ lbs

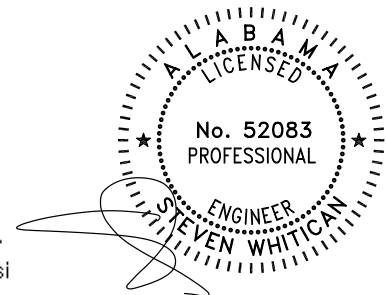

Project Description: Glass Warehouse LLC / FutureGlass – Fabrikasi Posted Glass Railing System	Date: January 30, 2025	Customer: Glass Warehouse LLC / FutureGlass	
	Engineer: SH	Project #: EEV-24-0628	
	PER: 9361	Page #: Page 28 of 39	



YOU ENVISION IT – WE ENGINEER IT

1900 NE Miami Ct., Ste. 2-15
 Miami, FL 33132
 TEL: 954.399-8478 | FAX: 954.744.4738
 WEB: www.buildingdrops.com

Product Evaluation Report			
Manufacture: Glass Warehouse			
Product: Fabrikasi Posted Glass Railing			
Tension Design Value			
Concrete Anchor Calculations		Masonry Anchor Calculations	
Fastener type: 1/4" Dewalt Screw-Bolt+		Fastener type: 1/4" Dewalt Screw-Bolt+	
Reference: Manufacturer Published Data		Reference: Manufacturer Published Data	
Substrate: 3000 PSI Concrete or Greater		Substrate: Hollow Block CMU (Per ASTM C-90)	
Minimum embedment:	2.50 in	Minimum embedment:	- in
Minimum Spacing:	3.00 in	Minimum Spacing:	- in
Minimum edge distance:	3.00 in	Minimum edge distance:	- in
Allowable Design Value:	W = 647 lbs / anchor	Allowable Design Value:	W' = - lbs / anchor
Shear Design Value			
Concrete Anchor Calculations		Masonry Anchor Calculations	
Fastener type: 1/4" Dewalt Screw-Bolt+		Fastener type: 1/4" Dewalt Screw-Bolt+	
Reference: Manufacturer Published Data		Reference: Manufacturer Published Data	
Substrate: 3000 PSI Concrete or Greater		Substrate: Hollow Block CMU (Per ASTM C-90)	
Minimum embedment:	2.50 in	Minimum embedment:	- in
Minimum Spacing:	3.00 in	Minimum Spacing:	- in
Minimum edge distance:	3.00 in	Minimum edge distance:	- in
Allowable Design Value:	Z' = 375 lbs / anchor	Allowable Design Value:	Z' = - lbs / anchor

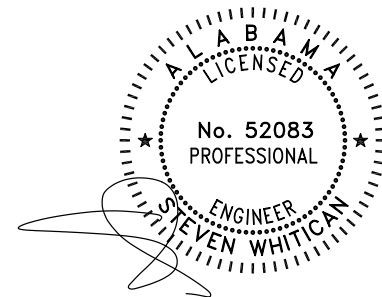

Project Description: Glass Warehouse LLC / FutureGlass – Fabrikasi Posted Glass Railing System	Date: January 30, 2025	Customer: Glass Warehouse LLC / FutureGlass	
	Engineer: SH	Project #: EEV-24-0628	
	PER: 9361	Page #: Page 29 of 39	



YOU ENVISION IT – WE ENGINEER IT

1900 NE Miami Ct., Ste. 2-15
 Miami, FL 33132
 TEL: 954.399-8478 | FAX: 954.744.4738
 WEB: www.buildingdrops.com

Product Evaluation Report			
Manufacture: Glass Warehouse			
Product: Fabrikasi Posted Glass Railing			
Tension Design Value			
Concrete Anchor Calculations		Masonry Anchor Calculations	
Fastener type: 3/8" Dewalt Screw-Bolt+		Fastener type: 3/8" Dewalt Screw-Bolt+	
Reference: Manufacturer Published Data		Reference: Manufacturer Published Data	
Substrate: 3000 PSI Concrete or Greater		Substrate: Hollow Block CMU (Per ASTM C-90)	
Minimum embedment:	2.50 in	Minimum embedment:	- in
Minimum Spacing:	3.00 in	Minimum Spacing:	- in
Minimum edge distance:	3.00 in	Minimum edge distance:	- in
Allowable Design Value:	W' = 1041 lbs / anchor	Allowable Design Value:	W' = - lbs / anchor
Shear Design Value			
Concrete Anchor Calculations		Masonry Anchor Calculations	
Fastener type: 3/8" Dewalt Screw-Bolt+		Fastener type: 3/8" Dewalt Screw-Bolt+	
Reference: Manufacturer Published Data		Reference: Manufacturer Published Data	
Substrate: 3000 PSI Concrete or Greater		Substrate: Hollow Block CMU (Per ASTM C-90)	
Minimum embedment:	2.50 in	Minimum embedment:	- in
Minimum Spacing:	3.00 in	Minimum Spacing:	- in
Minimum edge distance:	3.00 in	Minimum edge distance:	- in
Allowable Design Value:	Z' = 575 lbs / anchor	Allowable Design Value:	Z' = - lbs / anchor

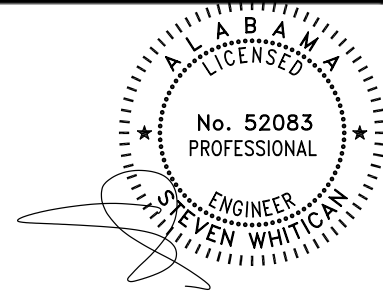

Project Description: Glass Warehouse LLC / FutureGlass – Fabrikasi Posted Glass Railing System	Date: January 30, 2025	Customer: Glass Warehouse LLC / FutureGlass	
	Engineer: SH	Project #: EEV-24-0628	Page #: Page 30 of 39
	PER: 9361		



YOU ENVISION IT – WE ENGINEER IT

1900 NE Miami Ct., Ste. 2-15
 Miami, FL 33132
 TEL: 954.399-8478 | FAX: 954.744.4738
 WEB: www.buildingdrops.com

Product Evaluation Report			
Manufacture: Glass Warehouse Product: Fabrikasi Posted Glass Railing			
Tension Design Value			
Concrete Anchor Calculations		Masonry Anchor Calculations	
Fastener type: 1/2" Dewalt Screw-Bolt+ Reference: Manufacturer Published Data Substrate: 3000 PSI Concrete or Greater Minimum embedment: 2.50 in Minimum Spacing: 3.00 in Minimum edge distance: 3.00 in Allowable Design Value: W' = 1347 lbs / anchor		Fastener type: 1/2" Dewalt Screw-Bolt+ Reference: Manufacturer Published Data Substrate: Hollow Block CMU (Per ASTM C-90) Minimum embedment: - in Minimum Spacing: - in Minimum edge distance: - in Allowable Design Value: W' = - lbs / anchor	
Shear Design Value			
Concrete Anchor Calculations		Masonry Anchor Calculations	
Fastener type: 1/2" Dewalt Screw-Bolt+ Reference: Manufacturer Published Data Substrate: 3000 PSI Concrete or Greater Minimum embedment: 2.50 in Minimum Spacing: 3.00 in Minimum edge distance: 3.00 in Allowable Design Value: Z' = 700 lbs / anchor		Fastener type: 1/2" Dewalt Screw-Bolt+ Reference: Manufacturer Published Data Substrate: Hollow Block CMU (Per ASTM C-90) Minimum embedment: - in Minimum Spacing: - in Minimum edge distance: - in Allowable Design Value: Z' = - lbs / anchor	

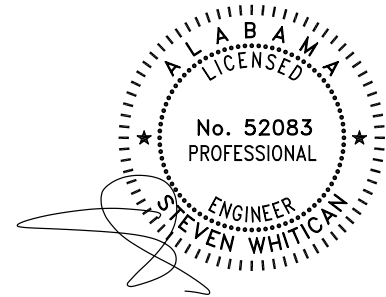

Project Description: Glass Warehouse LLC / FutureGlass – Fabrikasi Posted Glass Railing System	Date: January 30, 2025	Customer: Glass Warehouse LLC / FutureGlass	
	Engineer: SH	Project #: EEV-24-0628	Page #: Page 31 of 39
	PER: 9361		

Product Evaluation Report

Manufacture: Glass Warehouse
Product: Fabrikasi Posted Glass Railing

Manufacturer Published Data

Allowable Load Capacities for Screw-Bolt+ in Normal-Weight Concrete^{1,2,3,4,5}



Nominal Anchor Diameter in.	Minimum Nominal Embedment Depth in. (mm)	Minimum Concrete Compressive Strength									
		F _c = 2,500 psi (17.3 MPa)		F _c = 3,000 psi (20.7 MPa)		F _c = 4,000 psi (27.6 MPa)		F _c = 6,000 psi (41.4 MPa)		F _c = 8,000 psi (55.2 MPa)	
		Tension lbs (kN)	Shear lbs (kN)	Tension lbs (kN)	Shear lbs (kN)	Tension lbs (kN)	Shear lbs (kN)	Tension lbs (kN)	Shear lbs (kN)	Tension lbs (kN)	Shear lbs (kN)
1/4	1 (25)	330 (1.5)	415 (1.8)	350 (1.6)	440 (2.0)	385 (1.7)	480 (2.1)	430 (1.9)	520 (2.3)	430 (1.9)	520 (2.3)
	1-5/8 (41)	710 (3.2)	415 (1.8)	750 (3.3)	440 (2.0)	815 (3.6)	480 (2.1)	815 (3.6)	520 (2.3)	815 (3.6)	520 (2.3)
	2-1/2 (64)	915 (4.1)	505 (2.2)	965 (4.3)	535 (2.4)	1,050 (4.7)	585 (2.6)	1,070 (4.8)	635 (2.8)	1,070 (4.8)	635 (2.8)
3/8	1-1/2 (38)	660 (2.9)	890 (4.0)	720 (3.2)	975 (4.3)	835 (3.7)	1,125 (5.0)	1,020 (4.5)	1,375 (6.1)	1,020 (4.5)	1,590 (7.1)
	2 (51)	920 (4.1)	1,080 (4.8)	1,005 (4.5)	1,185 (5.3)	1,160 (5.2)	1,365 (6.1)	1,180 (5.2)	1,585 (7.1)	1,365 (6.1)	1,585 (7.1)
	2-1/2 (64)	1,295 (5.8)	1,080 (4.8)	1,415 (6.3)	1,185 (5.3)	1,600 (7.1)	1,365 (6.1)	1,615 (7.2)	1,585 (7.1)	1,855 (8.3)	1,585 (7.1)
	3-1/4 (83)	1,855 (8.3)	1,580 (7.0)	2,035 (9.1)	1,735 (7.7)	2,265 (10.1)	2,000 (8.9)	2,265 (10.1)	2,140 (9.5)	2,590 (11.5)	2,140 (9.5)
	4-1/2 (114)	2,725 (12.1)	1,580 (7.0)	2,985 (13.3)	1,735 (7.7)	3,450 (15.3)	2,000 (8.9)	3,770 (16.8)	2,140 (9.5)	3,770 (16.8)	2,140 (9.5)
1/2	1-3/4 (44)	710 (3.2)	1,495 (6.7)	780 (3.5)	1,640 (7.3)	900 (4.0)	1,895 (8.4)	1,100 (4.9)	2,320 (10.3)	1,100 (4.9)	2,675 (11.9)
	2-1/2 (64)	1,670 (7.4)	2,010 (8.9)	1,830 (8.1)	2,200 (9.8)	2,115 (9.4)	2,540 (11.3)	2,115 (9.4)	2,885 (12.8)	2,115 (9.4)	2,885 (12.8)
	3 (76)	2,140 (9.5)	2,010 (8.9)	2,345 (10.4)	2,200 (9.8)	2,690 (11.9)	2,540 (11.3)	2,690 (11.9)	2,885 (12.8)	2,690 (11.9)	2,885 (12.8)
	4-1/4 (108)	3,315 (14.7)	2,350 (10.5)	3,630 (16.1)	2,575 (11.5)	4,120 (18.3)	2,970 (13.2)	4,120 (18.3)	3,380 (15.0)	4,120 (18.3)	3,380 (15.0)
	5-1/2 (140)	3,935 (17.5)	2,350 (10.5)	4,310 (19.2)	2,575 (11.5)	4,975 (22.1)	2,970 (13.2)	5,330 (23.7)	3,380 (15.0)	5,330 (23.7)	3,380 (15.0)

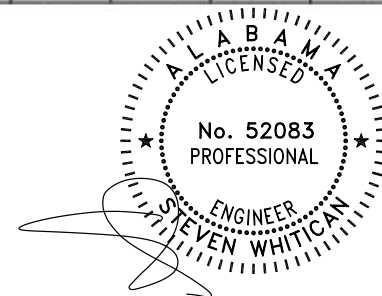

Project Description: Glass Warehouse LLC / FutureGlass – Fabrikasi Posted Glass Railing System	Date: January 30, 2025	Customer: Glass Warehouse LLC / FutureGlass	
	Engineer: SH	Project #: EEV-24-0628	Page #: Page 32 of 39
	PER: 9361		



YOU ENVISION IT – WE ENGINEER IT

1900 NE Miami Ct., Ste. 2-15
 Miami, FL 33132
 TEL: 954.399-8478 | FAX: 954.744.4738
 WEB: www.buildingdrops.com

5/16" Monolithic Tempered Glass - Supported Only by Posts

- Glass Thickness = 5/16 in
- Minimum Thickness = 0.292 in
- Average Thickness = 0.313 in
- Glass Temper = Fully Tempered:
- Glass Moment of Inertia = 0.025 in⁴
- Glass Section Modulus = 0.171 in³
- Glass MOR (Fr) = 24000 lbs/in²
- Glass Allowable Bearing Stress = 6000 lbs/in²
- Allowable Stress (Wind Load) = 9600 lbs/in²
- Glass MOE = 10400000 lbs/in²
- Allowable Moment Live Loads, M_L = 1023.17 in-lb/ft
- Allowable Moment Wind Load, M_w = 1637.07 in-lb/ft

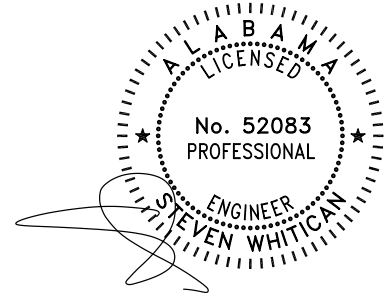

$$W = M_{aw} * 8 / L^2$$

Allowable Wind Load (PSF) - 5/16" Tempered Glass							
Post Spacing (in.)							
36.0	42.0	48.0	54.0	60.0	66.0	72.0	78.0
121.26	89.09	68.21	53.90	43.66	36.08	30.32	25.83

$$M_e = PL / (4 * H^{0.8})$$

Max. Post Spacing (in.) for 200lb Concentrated Load - 5/16" Tempered Glass							
Glass Height (in.)							
36.0	42.0	48.0	54.0	60.0	66.0	72.0	78.0
49.28	55.75	62.03	68.16	74.16	80.03	85.80	91.48

Max. Post Spacing (in.) for 50plf Live Load - 5/16" Tempered Glass							
Glass Height (in.)							
36.0	42.0	48.0	54.0	60.0	66.0	72.0	78.0
68.78	73.15	77.17	80.89	84.37	87.65	90.76	94.44

Allowable Wind Load Table (PSF) - 5/16" Tempered Glass								
Glass Height (in.)	Post Spacing (in.)							
	36.0	42.0	48.0	54.0	60.0	66.0	72.0	78.0
36.0	121.26	89.09	68.21	-	-	-	-	-
42.0	121.26	89.09	68.21	53.90	-	-	-	-
48.0	121.26	89.09	68.21	53.90	43.66	-	-	-
54.0	121.26	89.09	68.21	53.90	43.66	36.08	-	-
60.0	121.26	89.09	68.21	53.90	43.66	36.08	30.32	-

Project Description: Glass Warehouse LLC / FutureGlass – Fabrikasi Posted Glass Railing System	Date: January 30, 2025	Customer: Glass Warehouse LLC / FutureGlass	
	Engineer: SH	Project #: EEV-24-0628	
	PER: 9361	Page #: Page 33 of 39	



YOU ENVISION IT – WE ENGINEER IT

1900 NE Miami Ct., Ste. 2-15
 Miami, FL 33132
 TEL: 954.399-8478 | FAX: 954.744.4738
 WEB: www.buildingdrops.com

3/8" Monolithic Tempered Glass - Supported Only by Posts

- Glass Thickness = 3/8 in
- Minimum Thickness = 0.355 in
- Average Thickness = 0.375 in
- Glass Temper = Fully Tempered
- Glass Moment of Inertia = 0.045 in⁴
- Glass Section Modulus = 0.252 in³
- Glass MOR (Fr) = 24000 lbs/in²
- Glass Allowable Bearing Stress = 6000 lbs/in²
- Allowable Stress (Wind Load) = 9600 lbs/in²
- Glass MOE = 10400000 lbs/in²
- Allowable Moment Live Loads, M_L = 1512.30 in-lb/ft
- Allowable Moment Wind Load, M_w = 2419.68 in-lb/ft

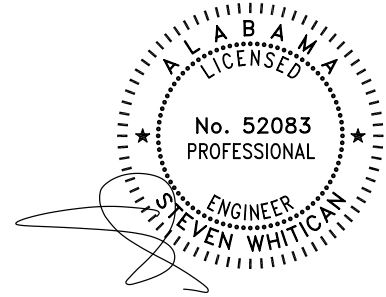

$$W = M_{aw} * 8 / L^2$$

Allowable Wind Load (PSF) - 3/8" Tempered Glass							
Post Spacing (in.)							
36.0	42.0	48.0	54.0	60.0	66.0	72.0	78.0
179.24	131.68	100.82	79.66	64.52	53.33	44.81	38.18

$$M_e = PL / (4 * H^{0.8})$$

Max. Post Spacing (in.) for 200lb Concentrated Load - 3/8" Tempered Glass							
Glass Height (in.)							
36.0	42.0	48.0	54.0	60.0	66.0	72.0	78.0
72.84	82.40	91.69	100.75	109.61	118.29	126.82	135.21

Max. Post Spacing (in.) for 50plf Live Load - 3/8" Tempered Glass							
Glass Height (in.)							
36.0	42.0	48.0	54.0	60.0	66.0	72.0	78.0
83.62	88.93	93.82	98.34	102.56	106.56	110.33	114.84

Allowable Wind Load Table (PSF) - 3/8" Tempered Glass								
Glass Height (in.)	Post Spacing (in.)							
	36.0	42.0	48.0	54.0	60.0	66.0	72.0	78.0
36.0	179.24	131.68	100.82	79.66	64.52	53.33	44.81	-
42.0	179.24	131.68	100.82	79.66	64.52	53.33	44.81	38.18
48.0	179.24	131.68	100.82	79.66	64.52	53.33	44.81	38.18
54.0	179.24	131.68	100.82	79.66	64.52	53.33	44.81	38.18
60.0	179.24	131.68	100.82	79.66	64.52	53.33	44.81	38.18

Project Description: Glass Warehouse LLC / FutureGlass – Fabrikasi Posted Glass Railing System	Date: January 30, 2025	Customer: Glass Warehouse LLC / FutureGlass	
	Engineer: SH	Project #: EEV-24-0628	
		PER: 9361	Page #: Page 34 of 39



YOU ENVISION IT – WE ENGINEER IT

1900 NE Miami Ct., Ste. 2-15
 Miami, FL 33132
 TEL: 954.399-8478 | FAX: 954.744.4738
 WEB: www.buildingdrops.com

1/2" Monolithic Tempered Glass - Supported Only by Posts

- Glass Thickness = 1/2 in
- Minimum Thickness = 0.469042 in
- Average Thickness = 0.500 in
- Glass Temper = Fully Tempered:
- Glass Moment of Inertia = 0.103 in⁴
- Glass Section Modulus = 0.440 in³
- Glass MOR (Fr) = 24000 lbs/in²
- Glass Allowable Bearing Stress = 6000 lbs/in²
- Allowable Stress (Wind Load) = 9600 lbs/in²
- Glass MOE = 10400000 lbs/in²
- Allowable Moment Live Loads, M_L = 2640.00 in-lb/ft
- Allowable Moment Wind Load, M_w = 4224.01 in-lb/ft

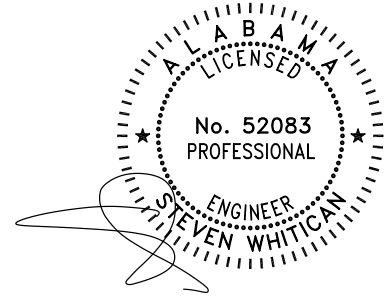

$$W = M_{aw} * 8 / L^2$$

Allowable Wind Load (PSF) - 1/2" Tempered Glass							
Post Spacing (in.)							
36.0	42.0	48.0	54.0	60.0	66.0	72.0	78.0
312.89	229.88	176.00	139.06	112.64	93.09	78.22	66.65

$$M_e = PL / (4 * H^{0.8})$$

Max. Post Spacing (in.) for 200lb Concentrated Load - 1/2" Tempered Glass							
Glass Height (in.)							
36.0	42.0	48.0	54.0	60.0	66.0	72.0	78.0
127.15	143.84	160.06	175.88	191.34	206.50	221.39	236.03

Max. Post Spacing (in.) for 50plf Live Load - 1/2" Tempered Glass							
Glass Height (in.)							
36.0	42.0	48.0	54.0	60.0	66.0	72.0	78.0
110.99	118.04	124.52	130.52	136.15	141.43	146.45	152.28

Allowable Wind Load Table (PSF) - 1/2" Tempered Glass								
Glass Height (in.)	Post Spacing (in.)							
	36.0	42.0	48.0	54.0	60.0	66.0	72.0	78.0
36.0	312.89	229.88	176.00	139.06	112.64	93.09	78.22	66.65
42.0	312.89	229.88	176.00	139.06	112.64	93.09	78.22	66.65
48.0	312.89	229.88	176.00	139.06	112.64	93.09	78.22	66.65
54.0	312.89	229.88	176.00	139.06	112.64	93.09	78.22	66.65
60.0	312.89	229.88	176.00	139.06	112.64	93.09	78.22	66.65

Project Description: Glass Warehouse LLC / FutureGlass – Fabrikasi Posted Glass Railing System	Date: January 30, 2025	Customer: Glass Warehouse LLC / FutureGlass	
	Engineer: SH	Project #: EEV-24-0628	
	PER: 9361	Page #: Page 35 of 39	



YOU ENVISION IT – WE ENGINEER IT

1900 NE Miami Ct., Ste. 2-15
 Miami, FL 33132
 TEL: 954.399-8478 | FAX: 954.744.4738
 WEB: www.buildingdrops.com

Effective Thickness of Laminated Glass: (ASTM E1300 APPENDIX X9)

3/16 + 0.06 PVB + 3/16 = 7/16 Laminated Glass

Glass Ply 1 Nominal Thickness: 3/16 in
 Glass Ply 2 Nominal Thickness: 3/16 in
 Interlayer Type: PVB
 Interlayer Complex Shear Modulus: 70 psi

Laminate Nominal Thickness: 7/16 in
 Glass Temper: Fully Tempered:

Glass Ply 1 min. Thickness (h1): 0.18 in
 Glass Ply 2 min. Thickness (h2): 0.18 in
 Interlayer Thickness (hv): 0.060 in

Laminate Minimum Thickness (hs): 0.240 in
 Ply 1 weighted Thickness (hs1): 0.120 in
 Ply 2 weighted Thickness (hs2): 0.120 in

Glass Inertia (Is): 0.0052 in³

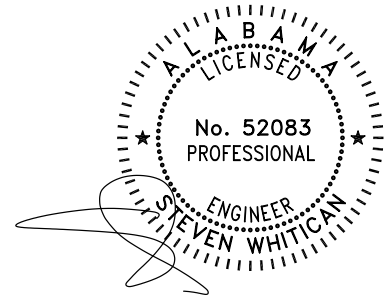

Glass Dimension (in)	Shear Transfer Coefficient (Γ)	Effective Thickness for Deflection (hef,w)	Effective thickness for Bending (h1;ef,σ)	Effective thickness for Bending (h2;ef,σ)	Section Modulus (in ³)	Allowable Moment (WL) (in-lb/ft)	Allowable Moment (LL) (in-lb/ft)
36	0.144	0.274	0.310	0.310	0.1923	1846.2	1153.9
42	0.186	0.285	0.322	0.322	0.2071	1987.7	1242.3
48	0.230	0.296	0.332	0.332	0.2210	2121.7	1326.1
54	0.275	0.306	0.342	0.342	0.2339	2245.4	1403.4
60	0.319	0.316	0.350	0.350	0.2456	2357.6	1473.5
66	0.361	0.324	0.358	0.358	0.2561	2458.4	1536.5
72	0.402	0.332	0.364	0.364	0.2654	2548.1	1592.6
78	0.441	0.339	0.370	0.370	0.2737	2627.7	1642.3

Allowable Stress (Fb_{WL}): 9600.00 psi

Allowable Stress (Fb_{LL}): 6000.00 psi

Project Description: Glass Warehouse LLC / FutureGlass – Fabrikasi Posted Glass Railing System	Date: January 30, 2025	Customer: Glass Warehouse LLC / FutureGlass	
	Engineer: SH	Project #: EEV-24-0628	
		PER: 9361	Page #: Page 36 of 39



YOU ENVISION IT – WE ENGINEER IT

1900 NE Miami Ct., Ste. 2-15
 Miami, FL 33132
 TEL: 954.399-8478 | FAX: 954.744.4738
 WEB: www.buildingdrops.com

Effective Thickness of Laminated Glass: (ASTM E1300 APPENDIX X9)

3/16 + 0.06 SGP + 3/16 = 7/16 Laminated Glass

Glass Ply 1 Nominal Thickness: 3/16 in
 Glass Ply 2 Nominal Thickness: 3/16 in
 Interlayer Type: SGP
 Interlayer Complex Shear Modulus: 1638.9 psi

Laminate Nominal Thickness: 7/16 in
 Glass Temper: Fully Tempered:

Glass Ply 1 min. Thickness (h1): 0.18 in
 Glass Ply 2 min. Thickness (h2): 0.18 in
 Interlayer Thickness (hv): 0.060 in

Laminate Minimum Thickness (hs): 0.240 in
 Ply 1 weighted Thickness (hs1): 0.120 in
 Ply 2 weighted Thickness (hs2): 0.120 in

Glass Inertia (Is): 0.0052 in⁴

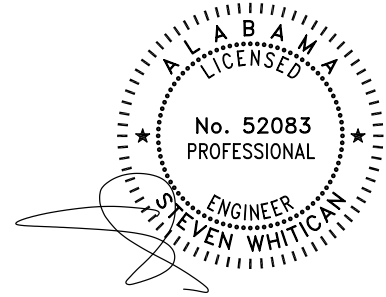

Glass Dimension (in)	Shear Transfer Coefficient (Γ)	Effective Thickness for Deflection (hef,w)	Effective thickness for Bending (h1;ef, σ)	Effective thickness for Bending (h2;ef, σ)	Section Modulus (in ³)	Allowable Moment (WL) (in-lb/ft)	Allowable Moment (LL) (in-lb/ft)
36	0.798	0.394	0.406	0.406	0.3301	3168.6	1980.4
42	0.843	0.400	0.410	0.410	0.3354	3220.0	2012.5
48	0.875	0.404	0.412	0.412	0.3391	3254.9	2034.3
54	0.899	0.407	0.413	0.413	0.3416	3279.5	2049.7
60	0.916	0.410	0.414	0.414	0.3435	3297.5	2060.9
66	0.930	0.411	0.415	0.415	0.3449	3311.0	2069.4
72	0.940	0.412	0.416	0.416	0.3460	3321.4	2075.9
78	0.949	0.413	0.416	0.416	0.3468	3329.6	2081.0

Allowable Stress (Fb_{WL}): 9600.00 psi

Allowable Stress (Fb_{LL}): 6000.00 psi

Project Description: Glass Warehouse LLC / FutureGlass – Fabrikasi Posted Glass Railing System	Date: January 30, 2025	Customer: Glass Warehouse LLC / FutureGlass	
	Engineer: SH	Project #: EEV-24-0628	
	PER: 9361	Page #: Page 37 of 39	



Effective Thickness of Laminated Glass: (ASTM E1300 APPENDIX X9)

1/4 + 0.06 PVB + 1/4 = 9/16 Laminated Glass

Glass Ply 1 Nominal Thickness: 1/4 in
 Glass Ply 2 Nominal Thickness: 1/4 in
 Interlayer Type: PVB
 Interlayer Complex Shear Modulus: 70 psi

Laminate Nominal Thickness: 9/16 in
 Glass Temper: Fully Tempered:

Glass Ply 1 min. Thickness (h1): 0.219 in
 Glass Ply 2 min. Thickness (h2): 0.219 in
 Interlayer Thickness (hv): 0.060 in

Laminate Minimum Thickness (hs): 0.279 in
 Ply 1 weighted Thickness (hs1): 0.140 in
 Ply 2 weighted Thickness (hs2): 0.140 in

Glass Inertia (Is): 0.0085 in³

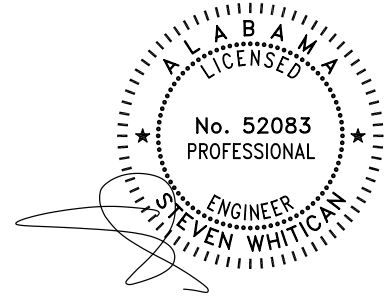

Glass Dimension (in)	Shear Transfer Coefficient (Γ)	Effective Thickness for Deflection ($h_{ef,w}$)	Effective thickness for Bending ($h1;ef,\sigma$)	Effective thickness for Bending ($h2;ef,\sigma$)	Section Modulus (in ³)	Allowable Moment (WL) (in-lb/ft)	Allowable Moment (LL) (in-lb/ft)
36	0.121	0.322	0.364	0.364	0.2645	2539.2	1587.0
42	0.158	0.334	0.376	0.376	0.2829	2715.4	1697.1
48	0.197	0.345	0.388	0.388	0.3007	2886.8	1804.2
54	0.237	0.356	0.399	0.399	0.3176	3049.2	1905.8
60	0.278	0.367	0.408	0.408	0.3334	3200.3	2000.2
66	0.317	0.377	0.417	0.417	0.3478	3338.9	2086.8
72	0.356	0.386	0.425	0.425	0.3609	3464.9	2165.5
78	0.394	0.394	0.432	0.432	0.3728	3578.6	2236.6

Allowable Stress (Fb_{WL}): 9600.00 psi

Allowable Stress (Fb_{LL}): 6000.00 psi

Project Description: Glass Warehouse LLC / FutureGlass – Fabrikasi Posted Glass Railing System	Date: January 30, 2025	Customer: Glass Warehouse LLC / FutureGlass	
	Engineer: SH	Project #: EEV-24-0628	
	PER: 9361	Page #: Page 38 of 39	



YOU ENVISION IT – WE ENGINEER IT

1900 NE Miami Ct., Ste. 2-15
 Miami, FL 33132
 TEL: 954.399-8478 | FAX: 954.744.4738
 WEB: www.buildingdrops.com

Effective Thickness of Laminated Glass: (ASTM E1300 APPENDIX X9)

1/4 + 0.06 SGP + 1/4 = 9/16 Laminated Glass

Glass Ply 1 Nominal Thickness: 1/4 in
 Glass Ply 2 Nominal Thickness: 1/4 in
 Interlayer Type: SGP
 Interlayer Complex Shear Modulus: 1638.9 psi

Laminate Nominal Thickness: 9/16 in
 Glass Temper: Fully Tempered:

Glass Ply 1 min. Thickness (h1): 0.219 in
 Glass Ply 2 min. Thickness (h2): 0.219 in
 Interlayer Thickness (hv): 0.060 in

Laminate Minimum Thickness (hs): 0.279 in
 Ply 1 weighted Thickness (hs1): 0.140 in
 Ply 2 weighted Thickness (hs2): 0.140 in

Glass Inertia (Is): 0.0085 in³

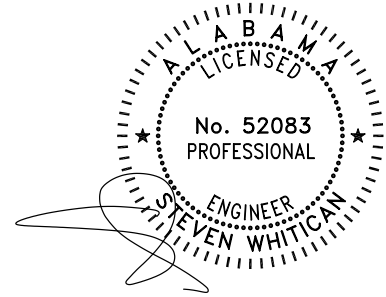

Glass Dimension (in)	Shear Transfer Coefficient (Γ)	Effective Thickness for Deflection (hef,w)	Effective thickness for Bending (h1;ef,σ)	Effective thickness for Bending (h2;ef,σ)	Section Modulus (in ³)	Allowable Moment (WL) (in-lb/ft)	Allowable Moment (LL) (in-lb/ft)
36	0.764	0.463	0.479	0.479	0.4590	4406.2	2753.9
42	0.815	0.471	0.484	0.484	0.4677	4490.2	2806.4
48	0.852	0.476	0.487	0.487	0.4737	4547.7	2842.3
54	0.879	0.481	0.489	0.489	0.4780	4588.6	2867.9
60	0.900	0.484	0.490	0.490	0.4811	4618.6	2886.6
66	0.916	0.486	0.492	0.492	0.4835	4641.3	2900.8
72	0.928	0.488	0.493	0.493	0.4853	4658.7	2911.7
78	0.938	0.489	0.493	0.493	0.4867	4672.5	2920.3

Allowable Stress (Fb_{WL}): 9600.00 psi

Allowable Stress (Fb_{LL}): 6000.00 psi

Project Description: Glass Warehouse LLC / FutureGlass – Fabrikasi Posted Glass Railing System	Date: January 30, 2025	Customer: Glass Warehouse LLC / FutureGlass	
	Engineer: SH	Project #: EEV-24-0628	
	PER: 9361	Page #: Page 39 of 39	