

SIDES

BOTTOM

Material: Aluminum Powder Coating Silver Grey

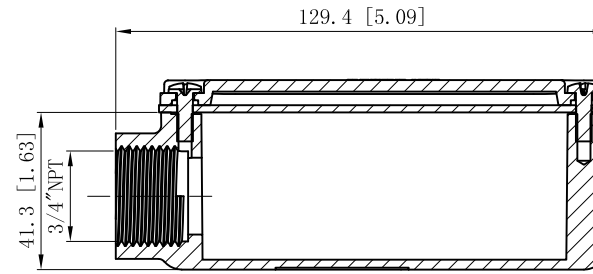
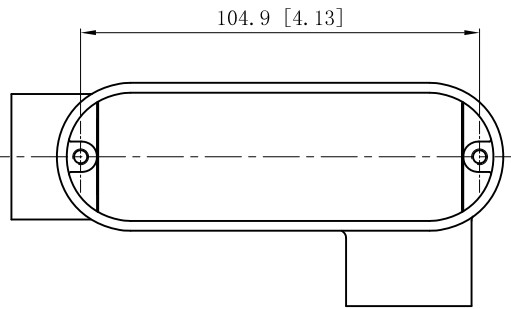

CUTAWAY VIEW A-A

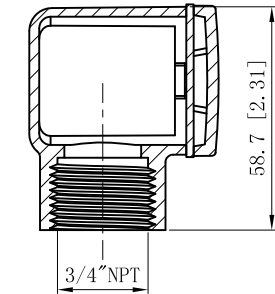
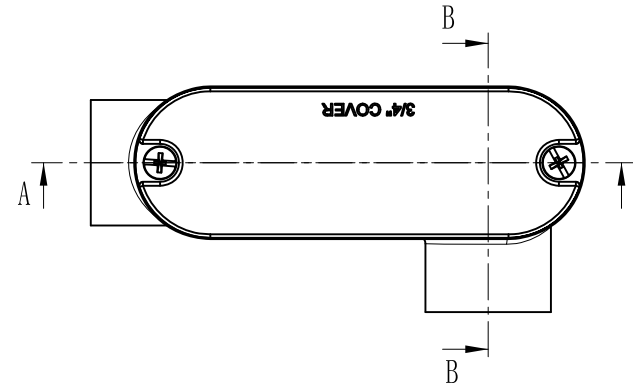
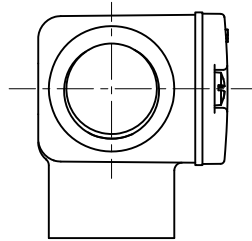

CUTAWAY VIEW B-B

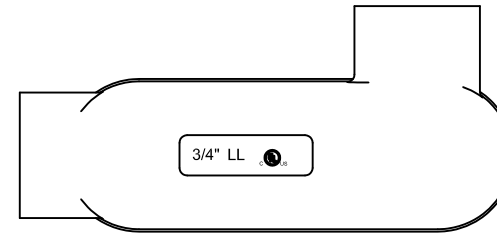
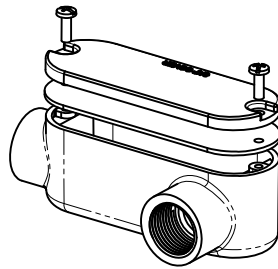

This data sheet is for reference only .GARVIN INDUSTRIES reserves the right to make changes to the design without prior notice.

DESCRIPTION

STANDARD PACKING

10 PCS

GARVIN INDUSTRIES

"LL" ALUMINUM CONDUIT BODY

TRADE REFERENCE TERMS

TITLE

SIZE

A4

DWG NO.

LL75

REV

DATA SHEET