

SPECIFICATIONS

DESCRIPTION

- 4364 4-function handshower
- Ø 3/4" (19mm) slide bar
- 59" (150 cm) shower hose with 2 check valves

FLOW

- 7.6 L/min (2 gpm) (80psi) max / 5.7 L/min (1.5 gpm) (45 psi) min
- 6.8L/min (1.8 gpm) (80psi) max / 5.1 L/min (1.3 gpm) (45 psi) min (4824-WS)

STANDARDS

- ASME A112.18.1 / CSA B125.1

WARRANTY

- Most products or parts carry "Limited Warranties" against manufacturing defects. For US customers please visit houseofrohl.com/support and for Canadian customers please visit houseofrohl.ca/support for complete product and finish warranty.



Handshower Set With 36" Slide Bar and 4-Function Handshower

MODELS: 4824

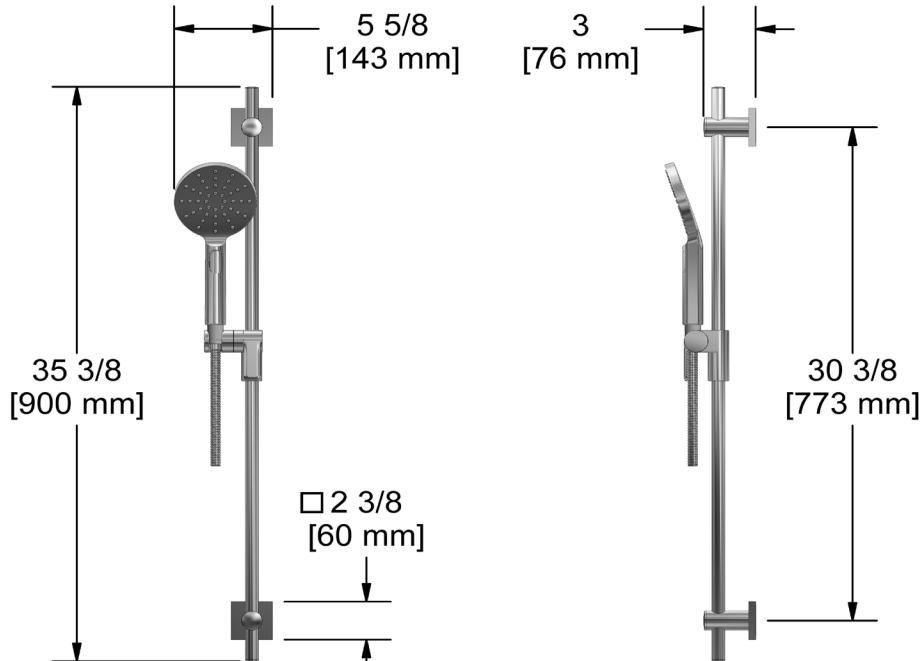

For warranty or additional information, contact:

US Customers

U.S.A.
houseofrohl.com/support
 1-800-777-9762

QUEBEC / MARITIMES / WESTERN CANADA
 QUÉBEC / MARITIMES / OUEST CANADIEN
 QUEBEC / MARITIMOS / CANADA OCCIDENTAL
houseofrohl.ca/support
 1-866-473-8442

Canadian Customers

ONTARIO
houseofrohl.ca/support
 1-800-287-5354

SPÉCIFICATIONS

DESCRIPTION

- 4364 douchette 4 fonctions
- Barre Ø 19mm (3/4")
- Boyau de douche 150 cm (59") avec 2 clapets anti-retour

DÉBITS DISPONIBLES

- 7.6 L/min (2 gpm) (80psi) max / 5.7 L/min (1.5 gpm) (45 psi) min
- 6.8L/min (1.8 gpm) (80psi) max / 5.1 L/min (1.3 gpm) (45 psi) min (4824-WS)

CERTIFICATIONS

- ASME A112.18.1 / CSA B125.1

GARANTIE

- La plupart des produits ou pièces comprend des «garanties limitées» contre les défauts de fabrication. Pour les clients des États-Unis: veuillez consulter houseofrohl.com/support; Pour les clients du Canada : veuillez consulter houseofrohl.ca/support pour connaître les conditions complètes de la garantie des produits et finis.



Douchette sur rail

MODÈLES : 4824

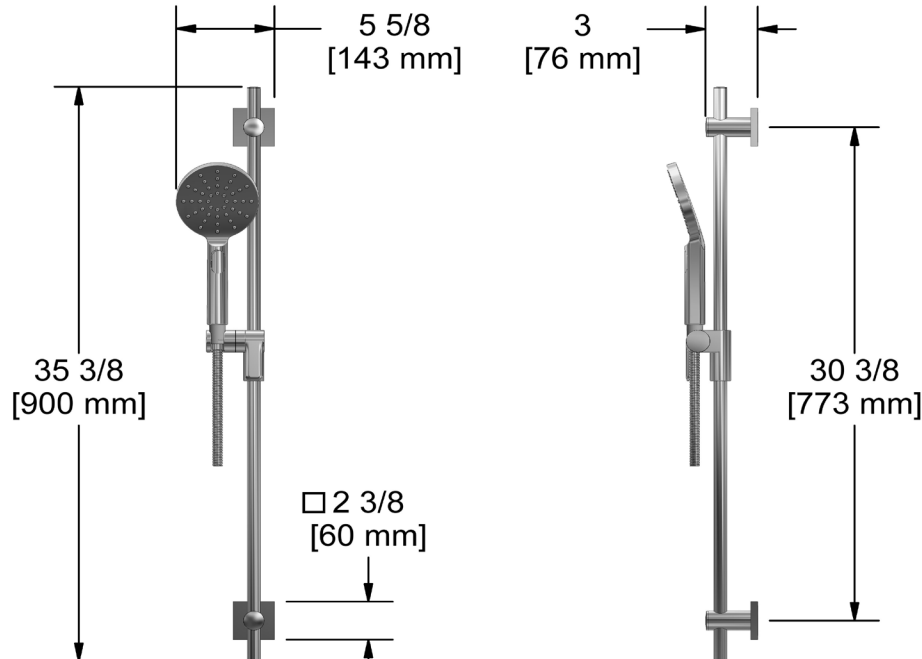

For warranty or additional information, contact:

US Customers

U.S.A.
houseofrohl.com/support
 1-800-777-9762

QUEBEC / MARITIMES / WESTERN CANADA
 QUÉBEC / MARITIMES / OUEST CANADIEN
 QUEBEC / MARITIMOS / CANADA OCCIDENTAL
houseofrohl.ca/support
 1-866-473-8442

Canadian Customers

ONTARIO
houseofrohl.ca/support
 1-800-287-5354

ESPECIFICACIONES

DESCRIPCIÓN

- Ducha de mano de 4 funciones 4364
- Ø 19 mm (¾") barra de ducha
- Flexo de 150 cm (59") y 2 válvulas anti retorno

FLUJO

- 7.6 L/min (2 gpm) (80psi) max / 5.7 L/min (1.5 gpm) (45 psi) min
- 6.8L/min (1.8 gpm) (80psi) max / 5.1 L/min (1.3 gpm) (45 psi) min (4824-WS)

ESTÁNDARES

- ASME A112.18.1 / CSA B125.1

GARANTÍA

- La mayoría de los productos o piezas cuentan con "Garantías Limitadas" por defectos de fabricación. A los clientes en EE. UU. se les recomienda visitar houseofrohl.com/support y a los clientes en Canadá, houseofrohl.ca/support, para consultar las condiciones completas de la garantía de los productos y acabados.



Barra de ducha de mano

MODELOS: 4824

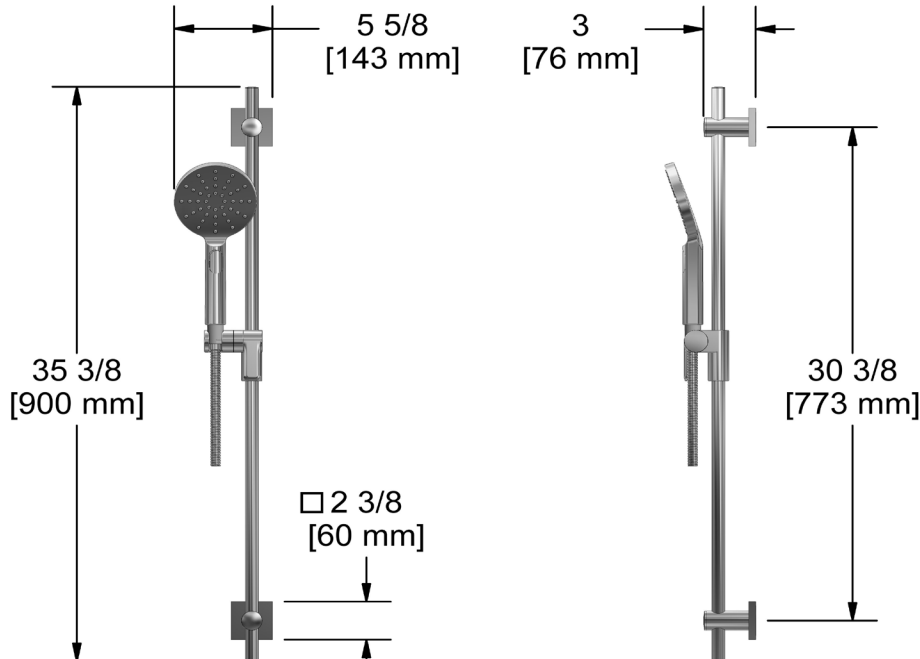

For warranty or additional information, contact:

US Customers

U.S.A.
houseofrohl.com/support
 1-800-777-9762

QUEBEC / MARITIMES / WESTERN CANADA
 QUÉBEC / MARITIMES / OUEST CANADIEN
 QUEBEC / MARITIMOS / CANADA OCCIDENTAL
houseofrohl.ca/support
 1-866-473-8442

Canadian Customers

ONTARIO
houseofrohl.ca/support
 1-800-287-5354