

SIDES	BOTTOM
Material: 316 Stainless steel	

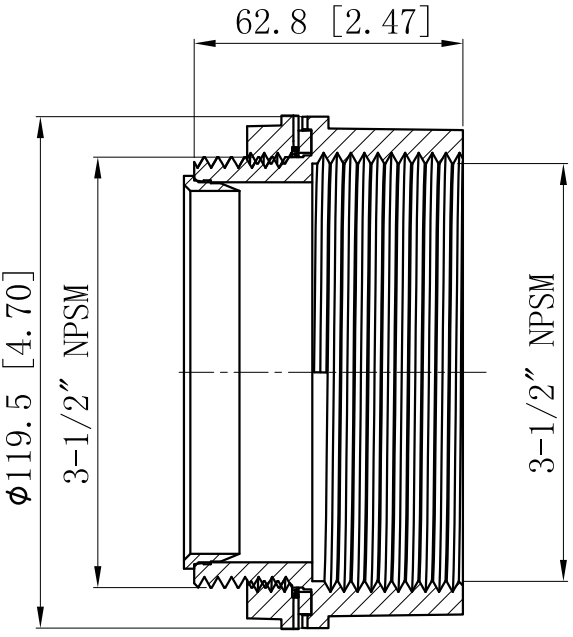

CUTAWAY VIEW A-A

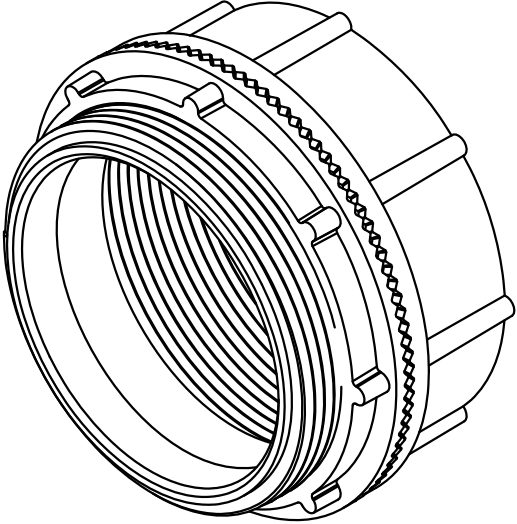
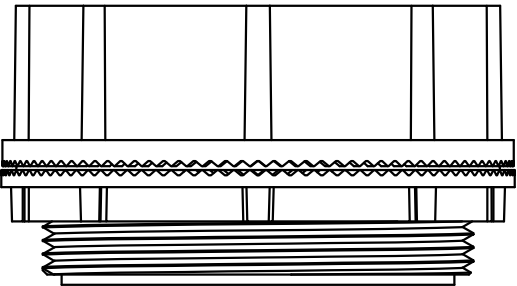
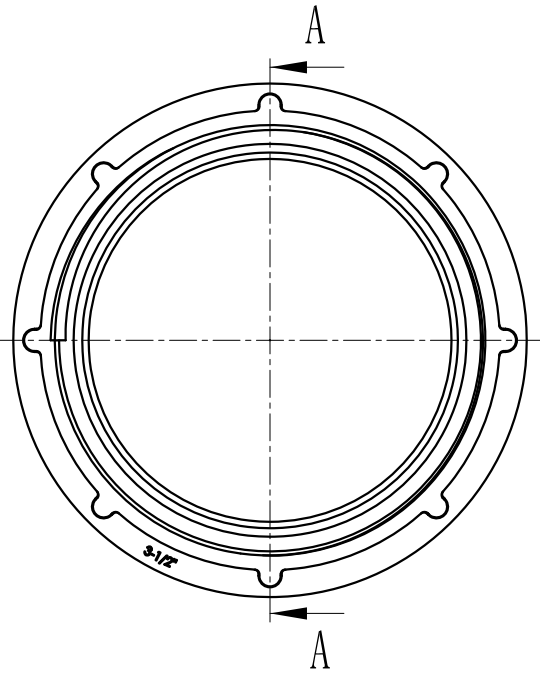

DESCRIPTION
TRADE REFERENCE TERMS

This data sheet is for reference only .GARVIN INDUSTRIES reserves the right to make changes to the design without prior notice.

STANDARD PACKING	<h1 style="text-align: center;">GARVIN INDUSTRIES</h1> <h2 style="text-align: center;">WATERTIGHT HUB (INSULATED THROAT)</h2>		
5 PCS			
	TITLE	DWG NO.	REV
	SIZE A4	WH350-SS	
	DATA SHEET		