





Assembly Instructions

Smita KD Tray Table

HARDWARE LIST:-

NO.	DESCRIPTION	IMAGE	QTY
A	ALLEN KEY (4mm)		1
B	ALLEN BOLT (10X13mm)		1
C	L PATTI		1

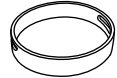
PART LIST:-

NO.	DESCRIPTION	IMAGE	QTY
D	WOOD TRAY		1
E	STAND		1

Step :- 1

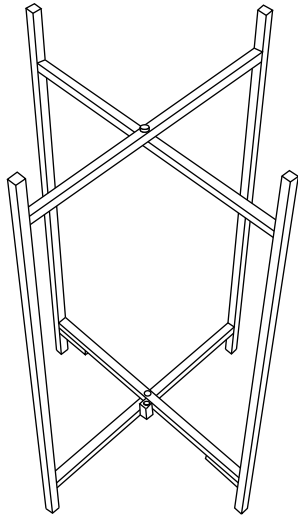

Step :- 2

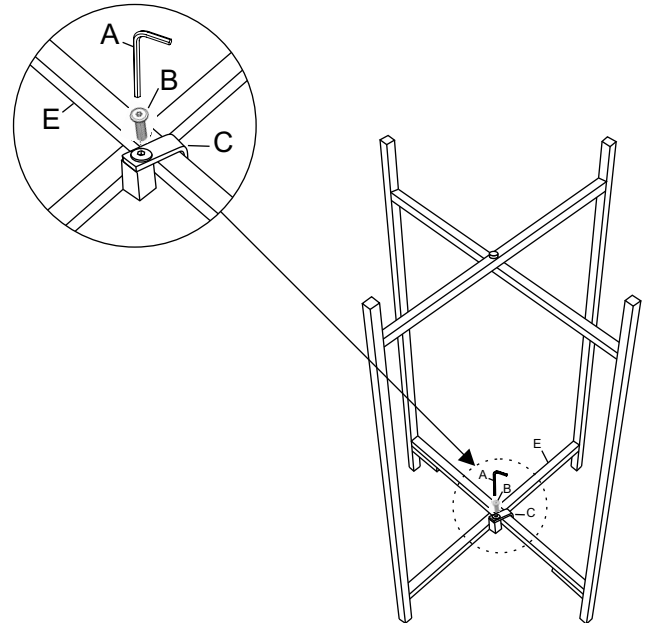

Step :- 3

