

USER'S MANUAL

BV7335B

BLUETOOTH® | DVD/MP3/CD
AM/FM RECEIVER

FEATURING 3.2" (81mm) WIDESCREEN DIGITAL TFT MONITOR



BOSS®
AUDIO SYSTEMS

Thank you for choosing Boss Audio Systems! This unit will bring you years of enjoyment.

CONTENTS

Safety Precautions.....	2-3
Installation.....	4-6
Wiring Connections.....	7
Controls Of The Unit.....	8
Basic Operation.....	9
Radio Operation.....	10
DVD/VCD/CD/MP3/WMA Operation.....	11-15
Bluetooth Operation.....	16
Other Operation.....	17
Maintenance.....	18
IR Remote Control.....	19
Troubleshooting Guide.....	20
Specifications.....	20

SAFETY PRECAUTIONS

- ⚠ Important Warnings to Take Note of BEFORE Starting the Installation**
- ⚠ Damage Caused By Incorrect Installation or Usage is NOT Covered By Warranty. PLEASE Take the Time to Read the Installation Notes Carefully.**
- ⚠ Please make all necessary connections and terminate any unused wires so they do not short. If you feel uncomfortable performing the install consult a professional installer.**

- To ensure safety while driving and to comply with laws, drivers should not watch video or operate the video device while driving
- To avoid any possible damage to your vehicles electrical system, be sure to disconnect the battery cable before beginning installation.
- The unit is intended for vehicles with a 12-volt battery and negative grounding.
- Before installing the unit in a recreational vehicle, truck, or bus, check that the battery voltage is 12 volts.
- Remove the two transport screws from the top of the unit before installation.
- Be sure to connect the negative (-) speaker leads to the negative (-) speaker terminal. Never connect the negative (-) speaker leads to chassis ground.
- This unit is only designed for use with 4 speakers. Do not combine outputs for use with 2 speakers. Do not ground negative speaker leads to the chassis ground.
- Speakers connected to this unit must be 4 to 8 ohms. Connecting speakers with output and/or impedance values other than those noted there will result in damage to the head unit and the speakers.
- Check the condition of your speakers carefully - connecting the unit to old or degraded speakers may result in a fault which will damage the audio IC and invalidate the warranty.
- If this unit is installed in a vehicle that does not have an ACC (accessory) position on the ignition switch, the red lead of the unit should be connected to a terminal coupled with ignition switch ON/OFF operations. If this is not done, the vehicle battery may be drained when you are away from the vehicle for several hours.

SAFETY PRECAUTIONS

- Secure the wiring with zip ties or electrical tape. . To protect the wiring, wrap adhesive tape around them where they lie against metal parts. To avoid short-circuiting, cover all disconnected lead with insulating tape. There is a possibility of short-circuiting if the leads are not insulated.
 - Route and secure all wiring so it cannot touch any moving parts, such as the gear lever and handbrake. Do not route wiring in places that get hot, such as near the heater outlet. If the insulation of the wiring melts or gets torn, there is a danger of the wiring short circuiting to the vehicle's body.
 - Don't pass the yellow lead through a hole into the engine compartment to connect to the battery. This will damage the lead's insulation and cause a very dangerous short.
 - Do not shorten any leads, if you do, the protection circuit may fail to work when it should.
 - Never feed power to other equipment by cutting the insulation of the power supply lead of the unit and tapping into the lead. The current capacity of the lead will be exceeded, causing overheating.
 - Since a unique audio I/C circuit is employed, never wire so the speaker leads are directly grounded or the left and right - speaker leads are common.
 - When this product's source is switched ON, a control signal is turned on through the Blue/White lead. Connect to an external power amp's system remote control or the car's Auto-antenna relay control terminal (max. 500mA 12V DC).
 - Do not block any vents or heater panels, Blocking them will cause heat to build up and may result in fire.
 - When replacing the fuse(s) the replacement must be of the same amperage as shown on the fuse holder. Never replace a fuse with another of a different value. If the fuse blows again please contact your installation company.
 - Double check that all wiring and connections are correct before re-connecting the battery and turning on the unit.
- After completing the installation and before operating the unit, reconnect the battery, then press the (RES) button with a pointed object, such as a ball-point pen to set to unit to it's initial status. After pushing the button, wait a few seconds for the red light to flash.

INSTALLATION

Tools for Installation

2 removal wrenches are supplied for taking out the old unit and place with this brand name car radio. The following tools and supplies may also be needed for the installation:

Tools for Installation: Philips Screw-drivers /Machine Screws /Wire Stripper /Wire Cutter /Hammer /Pencil /Electrical Tape /Electric Drill

Supplies for Installation: Machine Screws /Crimp Connectors /14 Gauge Wire for Power Connections /14-16 Gauge Speaker Wires

The above are not supplied.

Before you install

We strongly recommend that this unit should be professionally installed by a VAT registered installer (this is a requirement to validate the warranty).

IMPORTANT: Remove the two transport screws from the top fo the unit before installing.

Remove the Old Unit from the Dashboard

1. Remove the outer trim frame.
2. Insert the keys supplied with the old unit into both sides of the unit as shown in figure below until they click. Pull to remove the old unit from the dashboard.

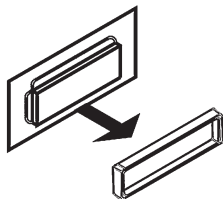

DIN Front Mount

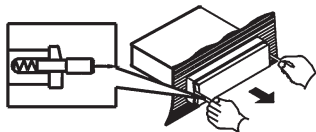

**DO NOT DISCONNECT WIRES
AT THIS TIME!**

Mark Polarity of the Speaker Wires

Marking the polarity of the speaker wires will make it easier to connect the existing speakers to your car radio. Consult wiring diagram of existing head unit before disconnecting any wires. If you are not positive of the polarity of the existing wires from the speakers to the head unit, install new wires.

1. While the old unit is playing, disconnect the wires from one speaker.
2. Take a length of masking tape and fold it around the wire so it forms a flag.
3. On the masking tape mark the polarity of the speaker wires (+&-), as well as left or right, and front or rear.
4. Double check that you marked the first speaker correctly by checking that the speaker wires are the same at the head unit.
5. Repeat this procedure for all of the speakers.
6. Mark the power, ground, and any other wires also.

INSTALLATION

WARNING!

Disconnect negative battery terminal from battery before starting installation.

NOTE: Mark the polarity of the existing speaker wires before disconnecting battery.

NOTE: Remove the two transport screws from the top of the unit before installing.

DIN Front Mount

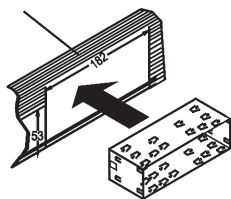

1. After removing the old radio and mounting sleeve, insert supplied mounting sleeve into opening.

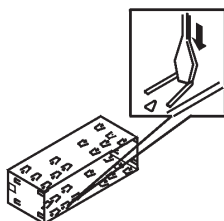

2. Bend the tabs on the mounting sleeve to keep the mounting sleeve firmly in place.

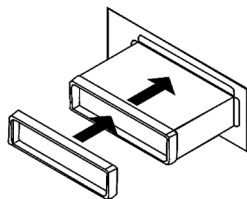

3. Attach wires from the unit to existing wires. See wiring connections diagram. Insert radio into dashboard. Then apply the trim frame to outside of radio.

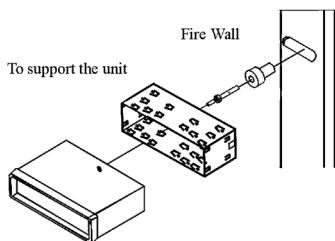

4. Support radio using rear mounting bolt and steel bar. (not included)

INSTALLATION

DIN Rear Mount

NOTE: Outer trim frame, hook, and mounting sleeve are not used for this installation

This is only intended as a general guide; contact the vehicle's manufacturer for specific instructions.

This method of installation uses the screw holes at the sides of the unit and the holes of the existing vehicle mounting bracket.

1. Remove the hooks on both sides.
2. Align the screw holes of the mounting bracket supplied with the car and the screw holes of the main unit. Tighten the 2 screws on each side of the unit. Then fasten the brackets to the car.
3. Attach wires of the unit to existing speaker wires. See wiring diagram.

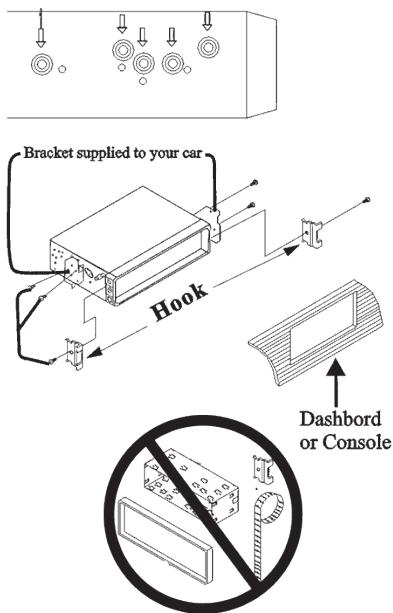

WIRING DIAGRAM

General Wiring Notes:

Black-Ground

Connect to vehicle body/chassis. Make sure you have a good chassis ground. This will eliminate most electrical noise from the motor and alternator. A good chassis ground requires a tight connection to ground. The area should be free from rust, paint or any form of dirt.

Light Green (Hand Brake)

Connect this wire to the hand brake wire of your car so that the display will be on only when the car is fully stopped.

Purple-White (Reverse, +12 V)

Connect this wire to the rear gear wire of your car so that the backup camera function can be activated when you car is in reverse gear.

Yellow (Constant, +12 V)

Connect to electrical terminal always supplied with power regardless of ignition switch position.

Blue/White Remote Output (+)

Connect to Auto-antenna or power amp control wire/remote connection. Maximum current 500mA.

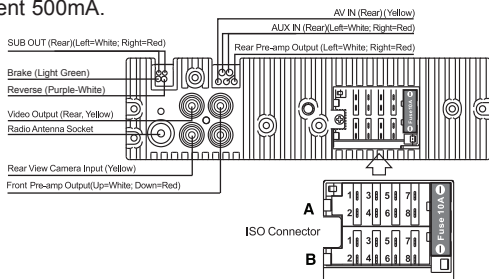

Connector A

1. Rear right speaker(+)/Purple
2. Rear right speaker(-)/Purple-Black
3. Front right speaker(+)/Grey
4. Front right speaker(-)/Grey-Black
5. Front left speaker(+)/White
6. Front left speaker(-)/White-Black
7. Rear left speaker(+)/Green
8. Rear left speaker(-)/Green-Black

Connector B

1. N/C
2. N/C
3. N/C
4. Battery 12V (+)/Yellow
5. Remote Trigger/Blue-White
6. N/C
7. ACC+/Red
8. Ground/Black

Speaker Wiring Notes:

Follow the above wiring diagram to install the head unit with new or existing speakers.

1. This unit is designed for use with four (4) speakers with impedance between 4 Ohms to 8 Ohms.
2. An Impedance load of less than 4 Ohms could damage the unit.
3. Never bridge or combine the speaker wire outputs. When not using four speakers, use electrical tape to tape the ends of the unused speaker outputs to prevent a short circuit.
4. Never ground the negative speaker terminals to chassis ground.

Controls Of The Unit

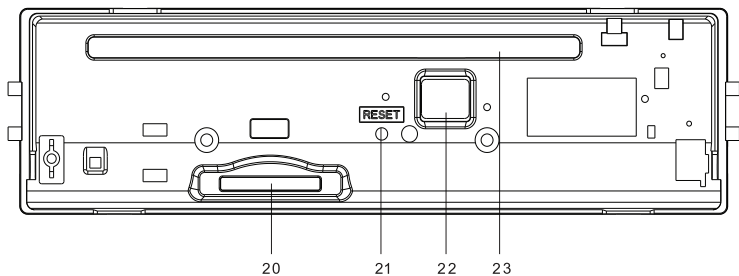
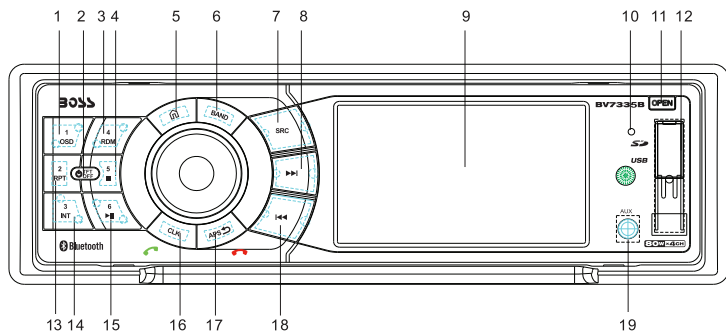

- | | |
|---|--|
| 1. Number 1/Statistical Disc Information Display Button | 12. USB Slot |
| 2. Power On/Off/TFT On/Off | 13. Number 2/Repeat Play |
| 3. Number 4/Random Play | 14. Number 3/Intro Scan |
| 4. Number 5/Stop play | 15. Number 6// Pause Function |
| 5. Main button | 16. Answer Button/Time Clock Display |
| 6. Band Select | 17. Reject Button/Auto Preset Scan/go back |
| 7. Mode Select | 18. Previous Track/Change Frequency |
| 8. Next Track/Change Frequency | 19. Aux Input Jack |
| 9. TFT Screen (3.2") | 20. SD Card Slot |
| 10. Mic Receiver | 21. Reset Button |
| 11. OPEN (Panel Release Button) | 22. Eject Disc Button |
| | 23. CD/DVD Window |

Basic Operation

1. Turning the unit on/off

Press the PWR button to turn the unit on. When the unit is on, press the PWR button once to turn the TFT off. Press this button again to turn the TFT back on. Press and hold the PWR button to turn the unit off.

2. Mode Selection

Press the SRC button to cycle the play mode between RADIO, USB, SD AUX IN, BT AV IN and BT-Music. Alternatively, press the MENU button and rotate the volume knob to select across different play modes.

3. Sound Control

A. Volume

Use the VOL +/- Button to adjust the volume level. Turn the button clockwise to increase the volume, and vice versa. The larger the number of volume, the higher the volume level.

B. Bass

Press the SEL Button until the display shows "BAS". Use the VOL +/- Button to adjust. When EQ is ON, bass control is not available.

C. Treble

Press SEL Button until the display shows "TRE". Use the VOL +/- Button to adjust. When EQ is ON, treble control is not available.

D. Balance

Press SEL Button until the display shows "BAL", then use the VOL +/- Button to adjust the balance between the left & right speakers.

E. Fader

Press SEL Button until the display shows "FAD", then use the VOL +/- Button to adjust the balance between the front & rear speakers.

F. Preset Equalizer Function – Press the MENU button and rotate the knob to enter SETUP. Select AUDIO and then EQ and then the type of EQ.

G. Beep on/off

Press the MENU button and rotate the knob to enter SETUP. Select GENERAL and then BEEP and then on or off.

H. MBP Bass/Loudness/EQ/Subwoofer

Press the MENU button and rotate the knob to enter SETUP. Select AUDIO and then choose the corresponding items to turn on or off.

4. Video Settings

Press the MENU button and rotate the knob to enter SETUP. Select VIDEO and then choose between Brightness, Contrast, Saturation, Hue to adjust.

5. Clock Settings

Press the MENU button and rotate the knob to enter SETUP. Select CLOCK and then you can set the time and clock display format.

6. APS/ > button

In USB/SD/Disc modes, during music or video playback press the APS/ > button once to go back to the directory page, in which you can choose the desired file by pressing and turning the volume knob, press again the APS/ > button to go back to the audio/video/image selected page.

Radio Operation

1. Choose Radio Band

Press the SRC Button to access the radio function. Then press the BAND button to choose among the five radio bands - three FM Bands (FM1, FM2, and FM3) and two AM Bands (AM1, and AM2). Each of the five bands can store up to six preset stations, for a total of 30 preset memory stations.

2. Radio Tune/Seek Function

In radio mode, press the |<< or >>| button to automatically seek the next strong and clear radio station. Press and hold the Seek +/- button until the screen shows MANU SEEK. At this time, you can manually fine tune your desired frequency. Wait until the MANU SEEK to disappear in order to perform auto seek again.

3. Automatic Store/Preset Scan

A. Automatic Scan & Store

While listening to the FM Radio, press and hold the APS Button for 3 seconds. The receiver will automatically scan and save stations for all the 3 FM Bands, whichever band (FM1, 2 or 3) you are listening to.

While listening to the AM Radio, press and the APS Button for 3 seconds. The receiver will automatically scan and save stations for the 2 AM Bands, whichever band (AM1 or 2) you are listening to.

B. Scan Saved Stations

Press the APS button or the AMS button on the remote control once to perform the scanning functions. In FM mode, press the APS button or the AMS button and the stations in that FM band will be scanned; press the button in AM mode and scan the band stations of that AM Band.

4. Save your Preset Stations

After choosing the preset stations in the list, you can adjust the frequency (by |<< or >>|), and save it by pressing and holding the volume knob. Alternatively, you can choose the preset station in the list after adjustment, then save it by pressing and holding the volume knob. The newly saved preset station will be refreshed and it will show the new radio frequency.

5.. Mono/Stereo Reception Control

Press ST button on the remote control to turn ST on or off. It means to select stereo or mono reception. Improvement of reception of weak stations can be done by selecting ST OFF operation which may cut down some reception noise.

6. Local/Distance Reception Control

Press LOC button on the remote control to turn LOC on or off. You can turn LOC on or off to select local or distance reception. Improvement of reception of distant stations can be done by selecting LOC OFF operation.

7. Radio Regions Setting

Press the MENU button and rotate the knob to enter SETUP. Select FUNCTION and then you can set the radio system/region and turn on or off RDS Control.

DVD/VCD/CD/MP3/WMA Operation

1.Insert / Eject

Press "Open" button, the front panel of the unit will slip down and then insert a disc into CD slot with label side up. The disc will be automatically loaded into the unit, even when it is off or at radio mode. Press "Open" button, the front panel of the unit will slip down, then press EJECT Button to eject the disc from the slot. If the disc is not removed from the slot within 5 seconds, it will automatically be loaded into the slot again. When the disc is ejected and removed, the unit will automatically switch to radio mode.

A. While you are playing CD disc, the screen will show the detail as picture 01. You can use the [<< | >>] to select the song you would like to listen.

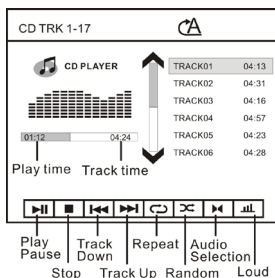
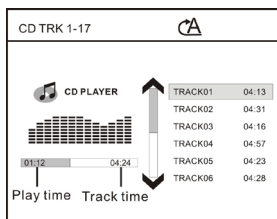

While you are playing CD disc, press OSD button on the front panel or on the remote, the screen will show the functions icon as picture 02, and then you can select this functions by turning and pressing volume knob, also you can select this functions direct by the panel buttons or remote button.

B. DVD

While you are playing DVD disc, the screen will show the details as picture 03. Press OSD button on the front panel or on the remote, the screen will show the functions icon as picture 04, and then you can select this functions by turning and pressing volume knob, also you can select this functions direct by the panel button or remote button.

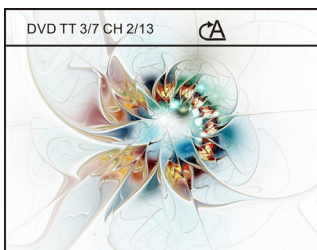

PIC:03

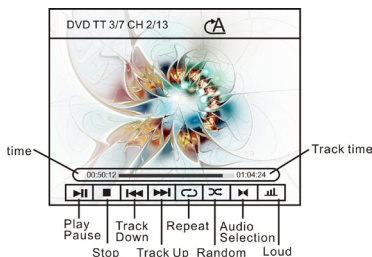

PIC:04

DVD/VCD/CD/MP3/WMA Operation (Con'd)

C. MP3 disc

While you are playing MP3 disc, the screen will show the details as picture 05. Press OSD button on the front panel or on the remote, the screen will show the functions icon as picture 06, and then you can select this functions by turning and pressing volume knob, also you can select this functions direct by the panel button or remote button.

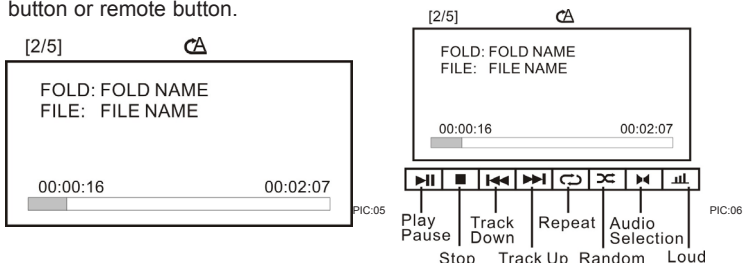

While you are playing DVD/CD/USB/SD, which contains audio/video/image formats, the unit will directly play the audio files. However, press APS/ > button on the front panel once to go to file list, press APS/ > again to go to folder list, press APS/ > third to select the format among audio, video, image, and then you can use the volume knob to select the file or folder or format that you would like to view/listen.

2. Title / PBC Playing

Press the TITLE button on the remote control so that the first title track of the DVD will be played. After playing, the current running track will be resumed. For VCD2.0, press the PBC button on the remote control while the disc is playing. You can switch between PBC on and PBC off mode.

3. Selecting Tracks

Press SEEK >>| or SEEK |<< On the Remote Control, Track numbers will be shown on the display. Press and hold the SEEK |<< Button to fast reverse. Disc will play normally when the SEEK >>| or SEEK |<< Button is released.

4. Button 1: Display OSD

The number 1-6 buttons contains dual functions during Disc play. Press the button for OSD functions, so that disc details will be displayed.

5. Button 2: Repeat

Press the button for repeating the same track continuously. "RPT" will appear on the display. Press this button again to stop repeating.

6. Button 3: Scanning Tracks

Press the button to play the first 10 seconds of each track. "INT" will appear on the display. Press this button again to resume playback.

7. Button 4: Random

Press the button to play all the tracks in random order. "RDM" will appear on the display. Press this button again to stop random play.

DVD/VCD/CD/MP3/WMA Operation (Con'd)

8. Button 5: Stop

Press the button to stop the disc from playing. The unit will be idle until further command is given. Press the No.6 button to play the disc again.

9. Button 6: Play/Pause

Press the No.6 Button to pause the CD. Press this button again to resume playback.

10. Audio Selection

Press the AUDIO button on the remote control, in order to choose the audio language. The audio languages available differ from Disc to Disc. You can also use the setup menu to confirm. Refer to the packing of the Disc for details.

VCD: Press AUDIO during playback it is possible to switch the sound between mono and stereo sound. The sequence is as follows:
Left Vocal --> Right Vocal --> Mono Left --> Mono Right --> Stereo

CD: Press AUDIO during playback. It is possible to switch the sound between mono and stereo sound. The sequence is as follows:
Mono Left --> Mono Right --> Stereo

11. Subtitle Selection

Press the Sub-T button on the remote control to choose the sub-title you want. The sub-title languages available differ from Disc to Disc. You can also use the setup menu to confirm. Refer to the packing of the Disc for details. Press ENTER to confirm.

12. Track Time Search

Press the GOTO button on the remote control to search the desired track time to play the Disc. The OSD will be prompted. Make use of the navigation keys and digit keys on the remote control to choose your desired chapter, track or time. Press the ENTER button to confirm your selection.

13. Zoom +/-

Press the ZOOM button on the remote control to perform the zoom function. The zoom range is from 1/4 up to 4 (total 7 stages), according to the zooming intensity.

14. Slow Motion

Press the SLOW button on the remote control to perform slow motion of the video play. SF 1/2 up to 1/7 will be shown, according to the slowness. Cycle back to normal playback of press the Play/Pause button to resume.

15. Multi-Angle View

Press the ANGLE button on the remote control to perform multi-angle playback. The number of angles change in sequential order.
Note: The number of angles is different according to the disc. The function only work for discs having scenes recorded at different angles. When no different angle is recorded, the OSD will show "INVALID KEY"

DVD/VCD/CD/MP3/WMA Operation (Con'd)

16. Programme Mode

Press the PROG button on the remote control to set the program play. Use the Navigation and Digit keys to set the Chapter and Track no. as your desired sequence. Press Enter to begin the program play. Press the PROG button and confirm a blank program again to cancel this operation.

17. Electronic Skip Protection

This unit is programmed with Electronic Shock Protection (ESP) so that the video/music will be protected against rough roads. Electronic Shock Protection time depends on the media that is being played. ESP for playing DVD is 5 seconds, for playing VCD is 10 seconds, for playing CD is 12 seconds, for MP3 is 180 seconds. This is built-in function so that there is no need to switch on or switch off.

SETUP MENU

The functions of the setup menu will be briefly described as follows:



System
Setup



Language
Setup



Audio
Setup



Video
Setup



Speaker
Setup



Digital
Setup

1. Functions of the setup menu are as follows:

From Left to Right:

A. System setup /B. Language setup /C. Audio setup /D. Video setup /E. Speaker setup /F. Digital setup

A. SYSTEM SETUP

a. TV TYPE -- This is to select the appropriate TV aspect (4:3 or 16:9) according to the connected TV set.

i) 4:3 PS -- Played back in the PAN & SCAN style. (If connected to wide-screen TV, the left and right edges are cut off.)

ii) 4:3 LB -- Played back in LETTERBOX style. (If connected to wide-screen TV, black bands appear at top and bottom of the screen)

iii) 16:9 -- Select when a wide-screen TV set is connected.

b. PASSWORD -- Press the STOP button for two times during playback, so that the disc play is completely stop. Press the right, left, down, up buttons orderly, then the setup menu for password will be prompted for you to set up the new password.

c. RATING -- Select Suitable guidance rating by the cursor button and confirm by pressing ENTER button.

Rating 1: [Kid Safe] -- Select it if the programs are safe to all kids view.

Rating 2: [G] -- Select it to indicate that it allows admission to person of all ages.

Rating 3: [PG] -- Select it to indicate that it needs parents to guide their children.

DVD/VCD/CD/MP3/WMA Operation (Con'd)

Rating 4: [PG_13] -- Select it to indicate that children under 13 are forbidden to view.

Rating 5: [PG_R] -- Select it if "PG_R" was printed on the DVD disc.

Rating 6: [R] -- Select it to indicate that children under 17 must be guided to view by their parents.

Rating 7: [NC-17] -- Select it to indicate that children under 17 are forbidden to view.

Rating 8: [ADULT] -- Select it to indicate that only adults are permitted to view.

B. LANGUAGE SETUP

Select the preferred OSD Language, Audio Language, Subtitle Language and Menu Language by using the navigation buttons. The default language is in English. Please refer to the setup tree to select language of the following categories:

- a. OSD Language
- b. Audio Language
- c. Subtitle Language
- d. Menu Language

C. AUDIO SETUP

a. KEY -- This is to select key up and down according to your needs.

D. VIDEO SETUP

This is to let the user set Brightness, Contrast, Hue, Saturation and Sharpness using the navigatio keys. Press ENTER button to confirm the setting of the video. The sequence of the video setup is as follows:

- a. BRIGHTNESS
- b. CONTRAST
- c. HUE
- d. SATURATION
- e. SHARPNESS

E. SPEAKERS SETUP

- a. DOWNMIX

F. DIGITAL SETUP

The following sequence will be available for setting:

- a. DYNAMIC RANGE
- b. DUAL MONO

Bluetooth Operation

Pairing Your Mobile Phone

Before using Bluetooth functions, you must pair your mobile phone to the unit. Pairing is a special process used when two devices connect for the first time. The pairing process is used to generate a link key that is used for authentication purposes for future Bluetooth connections between devices. Your mobile phone can initiate a search for a new device and pair the unit.

1. Access the mobile phone's Bluetooth function and set the Bluetooth function to on
2. Use the mobile phone's add a new device feature. "BOSS AUDIO" appears in the list on your mobile phone.
3. Select "BOSS AUDIO". The unit has an auto pairing function. It will search for the Bluetooth mobile phone and pair automatically.
NOTE: Some mobile phones require a "pass key" or pairing code to connect. If your phone requires a pass key or pairing code, you will need to enter this number. The default pairing code for the unit is "0000".

Auto-Reconnection

This unit has a built-in auto-reconnection function. In some conditions, the unit will auto reconnect with the mobile phone (note: the mobile phone must have been paired with the unit before.)

- When you turn off the unit and then turn it on again.
- Switch off the ACC wire and switch it on again.

Managing Incoming Calls



Answering an Incoming Call

Press the GREEN button to answer an incoming call.

Rejecting an Incoming Call

Press the RED button to reject the incoming call.

Remote Dial Operation

When connected to a mobile phone, use remote control to dial. Input the number you want to dial by pressing the number button on the remote control. After finishing all the numbers you are going to call, press  button to begin your call. During the dialing process, you can press the  button to delete the numbers you have inputted wrong.

Bluetooth Wireless Technology Music Function

Wireless products featuring Bluetooth technology provides an Advanced Audio Distribution Profile (A2DP) profile for streaming music from a mobile phone or a portable multimedia player (PMP), sometimes referred to as a MP3 player. The unit allows you to play back audio files from your mobile phone or a PMP using a Bluetooth connection.

Note: Your mobile phone must support this function. Please refer to your mobile phone's instruction manual.

When in A2DP mode

Press the PREVIOUS button on the front panel of the unit to choose the previous track.

Press the NEXT button on the front panel of the unit to choose the next track.

Press the APS/PAUSE button on the panel control to pause play.

Other Operations

1. Front and Rear Pre-amp Output x 4

The RCA Output Jack is on the back of the unit. (Refer to Wiring Diagram) This output is for connecting amplifier, equalizer, or other audio component that requires a pre-amp out connection. (Red=Right, White=Left) Follow the manufacturer's instructions for the audio component that you are connecting.

2. Video Output(Rear) x 1

The Video Output Jack is on the back of the unit. (Refer to Wiring Diagram) This output (in yellow) is for connecting monitor(s). You must connect a monitor for car in order to play this unit in another monitor. Consult your dealer for any kinds of monitors that are suitable to use in car.

3. Backup Camera Input(Rear) x 1

The backup camera input is on the back of the unit. (refer to wiring diagram). This input (in yellow) is for connecting backup camera for parking. You must connect the VCC wire (in pink color) to the reverse gear switch in order to activate this video input mode when you switch the reverse gear of your car. Please refer to the wiring diagram for more details.

4. SUB Pre-amp Output x 2

The Subwoofer Output Jack is on the output wire harness. (Refer to Wiring Diagram). Follow the amplifier's installation instructions.

5. Aux Input(Front) x 1

The Aux Input Jack is a 3.5mm connector on the front panel of the unit. Press the Mode button to choose AUX. Connect any portable audio device such as a discman or a portable MP3 player to the unit. Use the volume control to adjust volume.

6. AV Input(Rear) x 1

The AV Input Jack is a set of composite input on the rear of the unit. Press the Mode button to choose AUX. Connect any portable audio/video device such as a DVD player or VCD player to unit. Use the volume control to adjust volume.

Maintenance

Cleaning the Unit

Do not use any liquids to clean this unit.
Do not use petroleum distillates to clean this unit.
Use a clean, dry cloth to clean this unit.

Replacing the Fuse

Make sure the amperage matches the specified value when replacing the fuse(s). If the fuse is bad, check the power connection and replace the fuse with a new one. If the same problem occurs, this might indicate a malfunction within the unit.

Warning

When replacing a fuse, do not use a fuse with a higher amperage rating than the fuse originally supplied to your unit, otherwise damage will result to your unit.

IR Remote Control

- Power on/off
- Band Select
- Mode Select Key
- Play / Pause Function
- Mute Sound Function
- Show All Track's Title (DVD only)
- Display SETUP Menu
- Subtitle Language Switching Key

- Cursor Button in Menu Mode
- Confirm The Track/Chapter Selected or Select Item In SETUP Menu.
- Stop Playback
- Watch The DVD Content From Different Angle
- Play DVD in Slow Advance
- Repeat Play Function
- Program The Tracks To Be Played / Stereo Selection
- Adjust Volume Level
- Zoom In and Zoom Out Function
- Random Play Function / Local Selection
- Track Up / Down or Fast Forward / Backward
- Sound Select Button
- Reject Button/PBC Play Mode
- Answer Button/Statistical Disc Information Display Button
- Change The Audio Output Method
- Number Select Key
- Track Time Serach/*
- Track Time Serach/#



This unit comes with a full remote control system. The CR-2025 Lithium battery is an included item with the remote control. **TO PLACE THE BATTERY:**

- (1) Remove the cover from the back of the remote control.
- (2) Insert a CR-2025 Lithium battery.
- (3) Insert the battery holder into the back of the remote control.

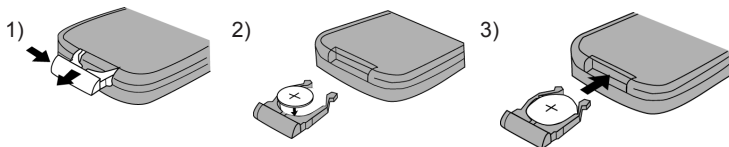

Operating the remote control

Aim at the face panel of the CD Receiver, the maximum distance at which signals can be received is about 6M. Make sure that the signal path is not obstructed. Do not drop or throw the remote control. Do not place the remote control in a location that is exposed to direct sunlight or next to a heating unit or other heat source.

Troubleshooting Guide

PROBLEM	CAUSE/SOLUTION
No Power	Check and make sure that the fuses did not blow.
Errors are displayed on the screen or no function is active	Unplug your car radio then plug it again
No radio reception	Check the connection of the antenna. Make sure the antenna is completely extended and that it is not broken
CDs cannot be loaded	A CD is already inside the appliance. Make sure that the fixing screws of the CD mechanism have been removed.
The stereo indicator is blinking	Set the frequency more accurately. The reception signal is too low.

Specifications

GENERAL

Operating Power.....	12 Volts DC, Negative Ground
Speaker output.....	4 speakers
Pre-amp Output.....	1v
Output Impedance.....	4 to 8 Ohm
Ohm Fuses.....	10amp
Dimensions.....	7" (W) x 7" (D) x 2" (H)
Weight.....	2.0kg

CD PLAYER

Signal / Noise Ratio.....	>80dB
Frequency Response.....	20 Hz~20KHz
Channel Separation.....	>50dB
D / A Converter.....	16 Bit

FM TUNER

Tuning Range.....	(USA) - 87.5 - 107.9MHz, (Europe) - 87.5 - 108 MHz
FM Sensitivity.....	12dBu
Stereo Separation @ 1 KHz.....	35dB

AM TUNER

Tuning Range.....	(USA) - 530-1710 KHz, (Europe) - 522-1620 KHz
AM Sensitivity.....	30dBu

USER'S MANUAL

BV7335B

BLUETOOTH® | DVD/MP3/CD AM/FM RECEIVER



BOSS Audio Systems

3451 Lunar Court • Oxnard, CA 93030

www.bossaudio.com | 805.751.4853

tech support: www.bossaudio.com/technical-support



0715

iPod® and iPhone® are trademarks of Apple, Inc. registered in the U.S. and other countries. BOSS Audio Systems is not affiliated with Apple, Inc. The Bluetooth® word mark and logos are registered trademarks owned by Bluetooth SIG, Inc. and any use of such marks by BOSS Audio Systems is under license. Other trademarks and trade names are those of their respective owners.