

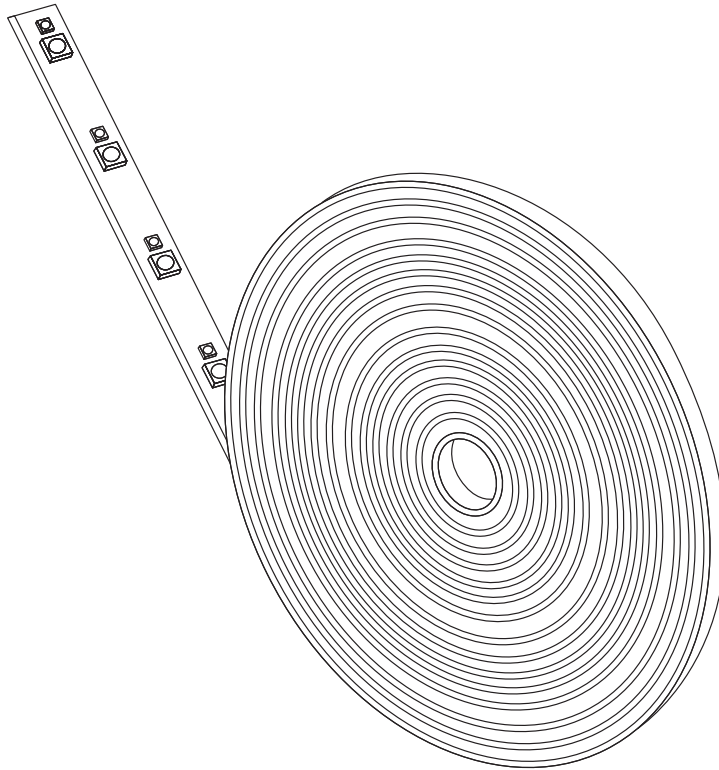

FLEXIBLE UNDER CABINET 192" TAPE LIGHT

IMPORTANT SAFETY INSTRUCTIONS AND INSTALLATION GUIDE



READ BEFORE INSTALLATION
SAVE THESE INSTRUCTIONS

Questions, problems, missing parts? Before returning to the store,
call Feit Electric Customer Service
8 a.m. - 5 p.m., PST, Monday - Friday

1-866-326-BULB (2852)

FEIT.COM

Table of Contents

Table of Contents	2
Safety Information	2
FCC Statement	2
Warranty	2
Pre-Assembly	3
LED Fixture Installation	4-5
The Tape Light can be Cut and Rejoined	5
Operating Instructions	6
Mounting Guide	7

Safety Information

SAVE THESE INSTRUCTIONS

IMPORTANT SAFEGUARDS:

ALWAYS FOLLOW BASIC SAFETY PRECAUTIONS WHEN USING ELECTRICAL PRODUCTS, ESPECIALLY WHEN CHILDREN ARE PRESENT.

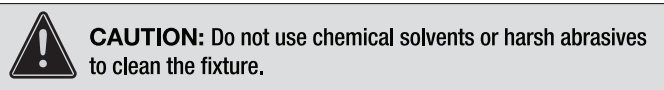
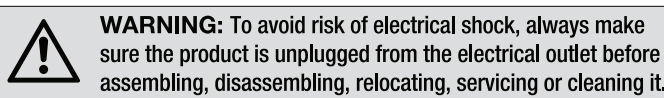
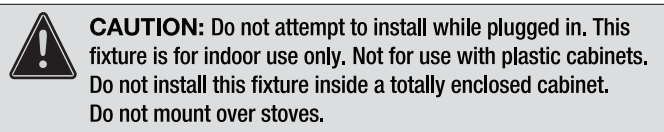
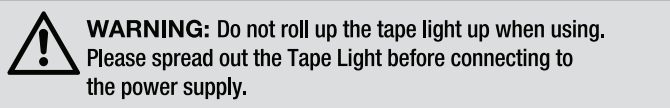
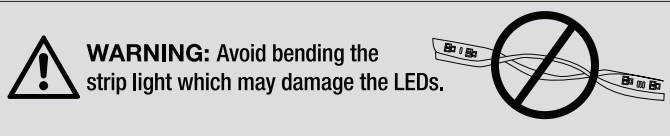

FCC STATEMENT

This device complies with part 15 of the FCC Rules. Operation is subject to the following two conditions:

(1) This device may not cause harmful interference, and (2) this device must accept any interference received, including interference that may cause undesired operation. Note: This equipment has been tested and found to comply with the limits for a Class B digital device, pursuant to part 15 of the FCC Rules. These limits are designed to provide reasonable protection against harmful interference in a residential installation. This equipment generates, uses and can radiate radio frequency energy and, if not installed and used in accordance with the instructions, may cause harmful interference to radio communications. However, there is no guarantee that interference will not occur in a particular installation. If this equipment does cause harmful interference to radio or television reception, which can be determined by turning the equipment off and on, the user is encouraged to try to correct the interference by one or more of the following measures: Reorient or relocate the receiving antenna. Increase the separation between the equipment and receiver. Connect the equipment into an outlet on a circuit different from that to which the receiver is connected. Consult the dealer or an experienced radio/TV technician for help. Any changes or modifications not expressly approved by the manufacturer could void the user's authority to operate the equipment. Feit Electric Company, 4901 Gregg Road, Pico Rivera, CA 90660. www.feit.com, 1-800-543-3348.

Limited Warranty

This product is warranted to be free from defects in workmanship and materials for up to 1 year from date of purchase. If the product fails within the warranty period, please contact Feit Electric at info@feit.com, visit feit.com/contact-us or call 1-866-326-BULB (2852) for instructions on replacement or refund. REPLACEMENT OR REFUND IS YOUR SOLE REMEDY. EXCEPT TO THE EXTENT PROHIBITED BY APPLICABLE LAW, ANY IMPLIED WARRANTIES ARE LIMITED IN DURATION TO THE DURATION OF THIS WARRANTY. LIABILITY FOR INCIDENTAL OR CONSEQUENTIAL DAMAGES IS HEREBY EXPRESSLY EXCLUDED. Some states and provinces do not allow the exclusion of incidental or consequential damages, so the above limitation or exclusion may not apply to you. This warranty gives you specific legal rights, and you may also have other rights which vary from state to state or province to province.

TOOLS REQUIRED

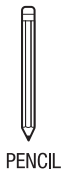

HARDWARE INCLUDED



NOTE: Hardware not shown to actual size.

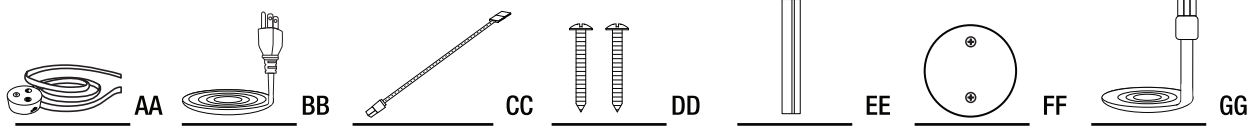

Part	Description	Quantity
AA	LED Tape Light & Controller	1
BB	6ft AC Cable	1
CC	6in. Linkable Cable	3
DD	Mounting Screws	2
EE	Mounting Bracket	1
FF	Fixture Mounting Template	1
GG	18in. Linkable Cable	1

Item No.	Description	Volts (V)	Wattage Per Fixture (W)	Input Current (mA)	Maximum Linkable Units at 120V
UCL192/FLEX/5CCT	Flexible Under Cabinet LED Tape Light	120	40	380	26

1 Position the Fixture

Find the desired place for the fixture and mark clearly using the provided mounting bracket template (FF).

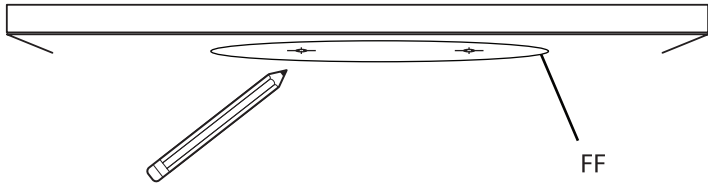

2 Installing the Mounting Bracket

Screw in the Mounting Bracket (EE) using the Mounting Screws (DD) on the marked locations.

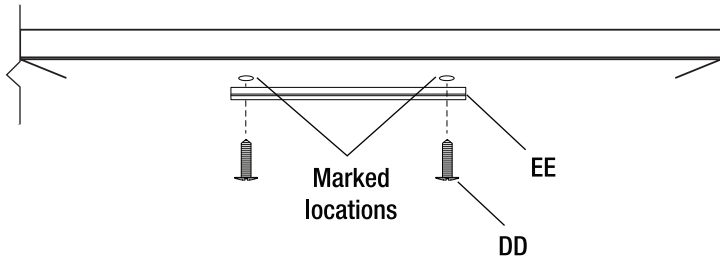

NOTE: Make sure the LED tape light is aligned in the desired direction.

3 Installing the Controller

Raise the Controller (BB) up and align the keyholes on the fixture to the Mounting Bracket (EE). Twist and lock the fixture into place by holding the fixture and gently rotating it in a counter-clockwise direction.

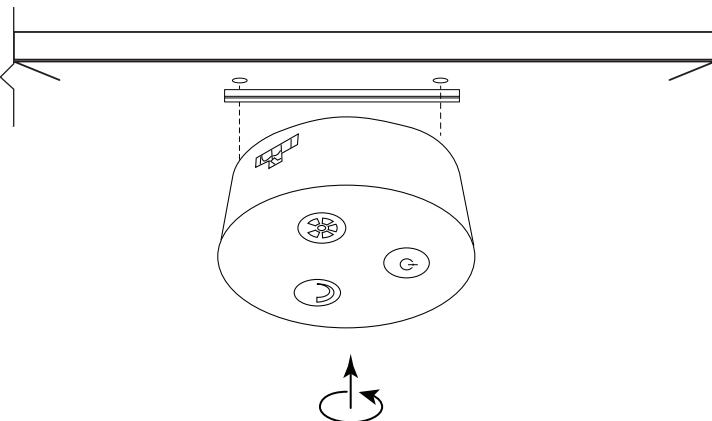

4 Cutting the Tape Light

Cut the Tape Light (AA) to the desired length at marked areas.

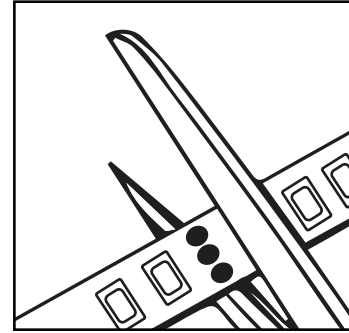

NOTE: Only cut to length at the 3 dots marks on the tape light. Any other areas will permanently damage the strip. (ensure the power supply is not plugged in at the wall outlet).

5 Mounting the Tape Light

Remove the adhesive backing paper to expose the adhesive (see Fig.1) and fix the Tape Light (AA) to the desired position.

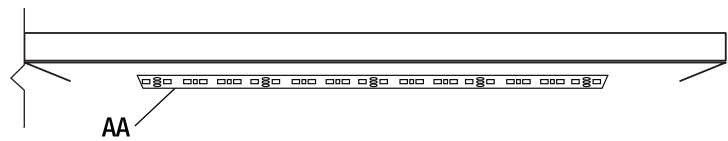
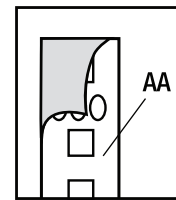

Fig. 1



NOTE: Clean the area thoroughly (surface must be free of dust, dirt or grease).

NOTE: Avoid removing and relaying the Strip Light multiple times as the adhesive may wear off.

6 Connecting the Power Supply

Plug in the power cord to the fixture.

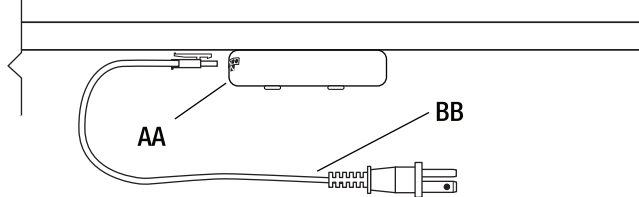

NOTE: The plug in cord can be connected to either side of fixture (AA).

7 Connecting to a Power Outlet

Connect the Electrical Plug (BB) to the power outlet on the wall.

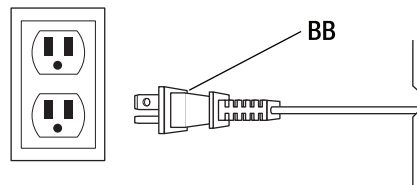

The Tape Light can be Cut and Rejoined

1 Removing the Heat-Shrink

Remove 1cm of heat-shrink covering the connection points and install the linkable connector (CC) (see Fig. 2).

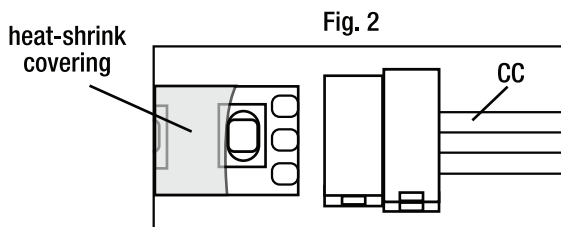

2 Adding the Connector

Open the end of the outer connector of the 6" connector (CC) and insert the end of the cut tape under the metal pins (see Fig. 3).

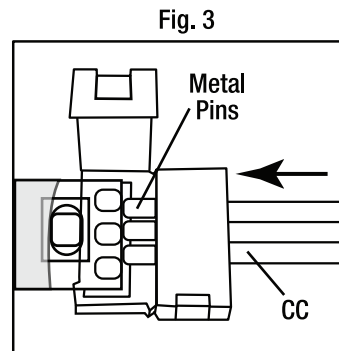

NOTE: To install 2 or more LED fixtures, repeat the single fixture installation instructions with two or more units.

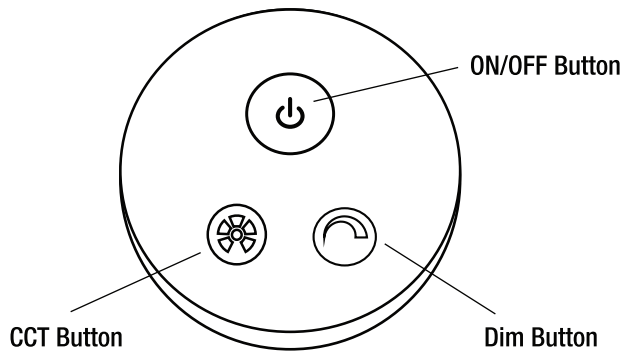

Use the Dim Button to Change the Dimming Levels

- To select the desired dimming level, cycle through the dimming levels (High, Medium, Low, Dim, Off) by pressing the Dim Button. This setting will be fixed each time the ON/OFF switch is turned ON.

Changing the Color Temperature Setting

- To select the desired color temperature, cycle through 2700K - 3000K - 3500K - 4000K - 5000K by pressing the CCT Button. This setting will be fixed each time the ON/OFF switch is turned ON.

This LED Fixture has the feature to operate and control multiple units, even if they are not linked.

- To control multiple fixtures, Hold the CCT button for 3 seconds on all the fixtures to be controlled in a group.
- To remove the individual fixture from the group, Hold the CCT button on the fixture that you want to control individually for 3 seconds.

CUT OUT TEMPLATE

