

Installation/Owner's Manual

PC Programmable

Telephone Entry and Access Control Systems

1835-065-A-10-16

26, 30 and 31-Bit Wiegand Compatible

1837

For 1837 circuit board:
Wall 1837-009 Revision V or higher.
Flush/Surface 1837-010 Revision V or higher.

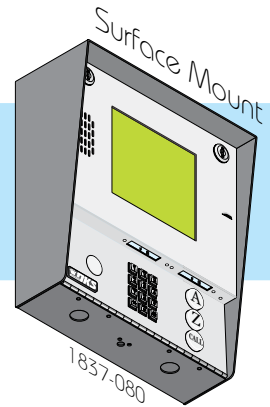
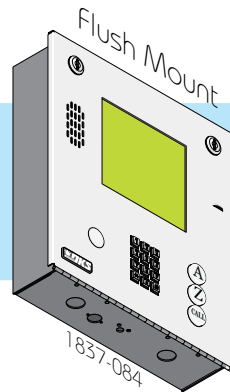
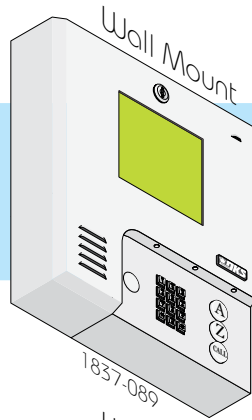

1835

For 1835 circuit board:
Wall 1835-009 Revision V or higher.
Flush/Surface 1835-010 Revision V or higher.

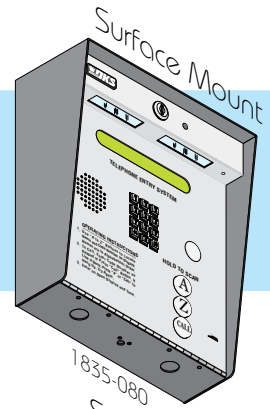
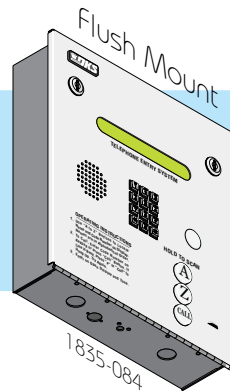
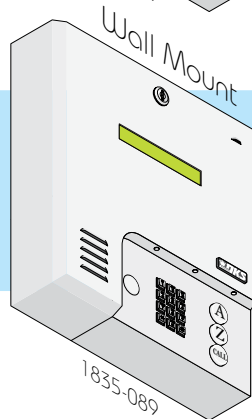

1833

For 1833 circuit board:
Flush/Surface 1833-010 Revision V or higher.

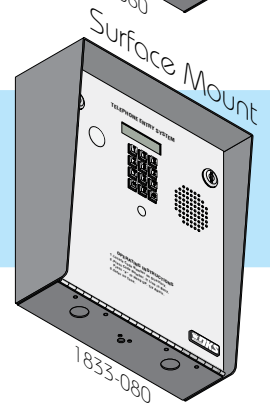
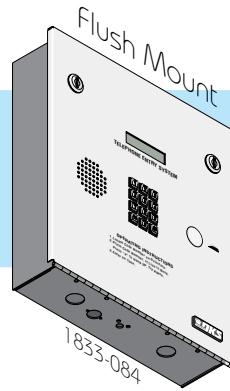

Date Installed: _____

Installer/Company Name: _____

Phone Number: _____

Model Number _____

Circuit Board
Serial Number
and Revision Letter: _____

Leave Manual with Owner

Download **REMOTE ACCOUNT MANAGER** Software **FREE** at:
<http://www.doorking.com/telephone/telephone-accessories/software-remote-account-manager>

Copyright 2016 DoorKing, Inc. All rights reserved.



QUICK GUIDE: Terminal Descriptions

See section 2.3 for terminal wiring.

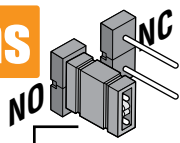

Relay 2 Note: Normally Open and Normally Closed relay jumper is used to set **Relay 2** input on the circuit board (See section 4.6).

Main Terminal																			
PHONE	CGND	PSW	MIC	COM	SPKR	IMD	5VDC	IMC	Z	A	2C	2RY	1C	1NC	1NO	BAT	16AC	16AC	
1	2	3	4	5	6	7	8	9	10	11	12	13	14	15	16	17	18	19	20
Phone Line Connection	Phone Line Connection	Earth Ground Only (See Section 2.1.3).	Switch Input. A closure between terminals 4 and 6 will cause the designated relay(s) to activate for the programmed strike time or dial a phone number – see 3.2.7. The Postal Switch is connected here.	Microphone Input.	Common for switch input #4, microphone, speaker, AZ & CALL buttons and battery neg.	Speaker Output.	(Not used).	5 VDC Power for LED lighting.	(Not used).	“Z” Button Input.	“A” Button Input.	Relay 2 Common – 30 Volt, 3 Amp max.	Relay 2 Contact – 30 Volt, 3 Amp max.	Relay 1 Common – 30 Volt, 3 Amp max.	Relay 1 Normally Closed – 30 Volt, 3 Amp max.	Relay 1 Normally Open – 30 Volt, 3 Amp max.	Back-up Battery POSITIVE For Phone System Only. (connect negative to terminal 6)	16 VAC Input Power	16 VAC Input Power
800 ft. max. with 24 AWG wire. 1600 ft. max. with 22 AWG wire. (Wiring MUST be twisted and completely isolated from the ground)																		100 ft. max. with 18 AWG wire. 200 ft. max. with 16 AWG wire. 20 VA min. for 1833, 1834 and 1835, 40 VA min. for 1837.	

Elevator Control Terminal

Note: Connect to the Elevator Control Board (2348-010). See **Elevator Control Board Manual** 2348-065 for more info.

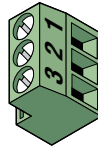

- 1 DATA 1 – Connect to terminal 20 of elevator control board.
- 2 DATA 0 – Connect to terminal 21 of elevator control board.
- 3 COMMON – Connect to terminal 22 of elevator control board.

Aux Terminal

Note: The 14-pin aux terminal can be removed for easy wiring. Expansion boards are connected here when used.

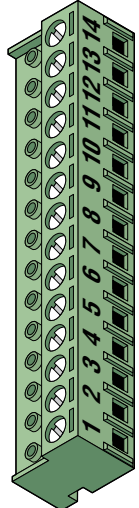

- 14 +12 VDC Power.
- 13 Common.
- 12 DATA 1.
- 11 DATA 0.
- 10 +12 VDC Power.
- 9 Common.
- 8 DATA 1.
- 7 DATA 0.
- 6 16 VAC Output.
- 5 16 VAC Output.
- 4 Back-up Battery NEGATIVE (For Wiegand Only).
- 3 Back-up Battery POSITIVE (For Wiegand Only).
- 2 16.5 VAC Input Power – 20 VA.
- 1 16.5 VAC Input Power – 20 VA. (Powers RS-232, elevator control and Wiegand)

See **Expansion Tracker Board Manual** 2358-065 and section 2.3.2, 2.3.3 for more information.

RS-232 Terminal

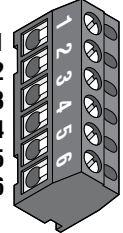

- Transmit Data 1
- Receive Data 2
- Request to Send 3
- Clear to Send 4
- Signal Ground - Shell 5
- Not used 6

Note: Located in the upper left corner of circuit board. The 6-pin terminal can be removed for easy wiring. Connects a PC (See Section 2.4.2).

Relay 0 Terminal

Non-Removable

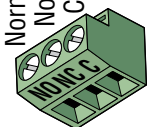

Normally Open – 30 Volt, 3 Amp max.
Normally Closed – 30 Volt, 3 Amp max.
Common – 30 Volt, 3 Amp max.

Overview for Entry System Keypad Programming

	Page #	Section	Command	Factory Setting
Section 3.2 Setup Entry System for PC Programming				
NOT Programmable from Software. Program from System Keypad ONLY.	26	3.2.1	Master Switch ON	No factory setting
	27	3.2.2	* 60	1 (255 area codes)
	27	3.2.3	* 78	0 (OFF)
	27	3.2.4	* 36	007 (7 sec)
	27	3.2.5	* 15	1 (tone ON)
	28	3.2.6	* 85	1 (19200 Baud)
	28	3.2.7	* 18	0 (activates relay)
	28	3.2.8	* 75	1 (Turned ON)
	28	3.2.9	* 04	Single system
	29	3.2.10	* 59	Issued by DoorKing
Testing IM Server	29	3.2.11	* 95	8-3000 Memory 2-Card w/Anti-Pass Back
	58	6.1.7	* 56	Testing Option
	58	6.1.8	* 29	Testing Option
58	6.1.9	* 55	Testing Option OFF	
Section 3.3 General Programming using System Keypad				
	31	3.3.1	* 03	Relay 0: 01 (1 sec) Relay 1: 01 (1 sec) Relay 2: 01 (1 sec)
	31	3.3.2	* 08	060 (60 sec)
	32	3.3.3	* 05	Relay 0: # # # # Relay 1: 9 8 7 6 Relay 2: 5 4 3 2
	32	3.3.4	* 50	010 (relay 1 activates)
	33	3.3.5	* 07	Touch-tone
	33	3.3.6	* 51	010 (relay 1 activates)
Section 3.4 Programming Letters, Numbers and Messages				
	34	3.4.1	None	No factory setting
	35	3.4.2	* 80	Factory message
	36	3.4.3	* 81	Factory message
	37	3.4.4	* 80	Factory message
	38	3.4.5	* 81	Factory message
Section 3.5 Programming Phone Numbers and Names				
	40	3.5.1	* 20	Three (3) digits
	40	3.5.2	* 01	No factory setting
	41	3.5.3	* 24	No factory setting
	41	3.5.4	* 41	No factory setting
	42	3.5.5	* 66	No factory setting
	42	3.5.6	* 01	No factory setting
	42	3.5.7	* 65	No factory setting
	43	3.5.8	* 24	No factory setting
	43	3.5.9	* 06	No factory setting
	43	3.5.10	* 09	No factory setting
	43	3.5.11	* 27	1 (Pause ON)
Section 3.6 Programming Device Codes - 1833, 1835, 1837 Only				
	44	3.6.1	* 70	No factory setting
	44	3.6.2	* 71	No factory setting
	44	3.6.3	* 72	No factory setting
	44	3.6.4	* 73	No factory setting
Section 3.7 Programming Four-Digit Entry Codes				
	45	3.7.1	* 02	No factory setting
	45	3.7.2	* 02	No factory setting
	45	3.7.3	* 12	No factory setting
Section 3.8 Anti-Pass Back				
	46	3.8.1	* 43	No factory setting
	46	3.8.2	* 45	No factory setting
	46	3.8.3	* 46	No factory setting
	46	3.8.4	* 48	No factory setting

SPECIFICATIONS

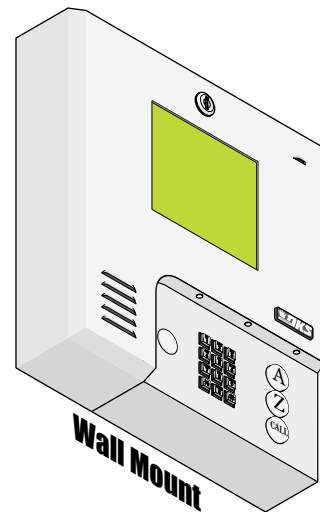
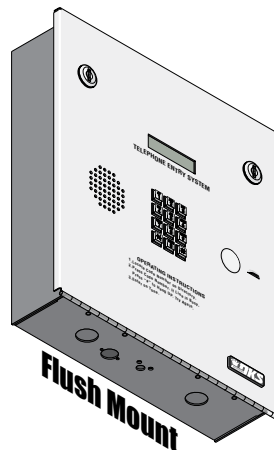
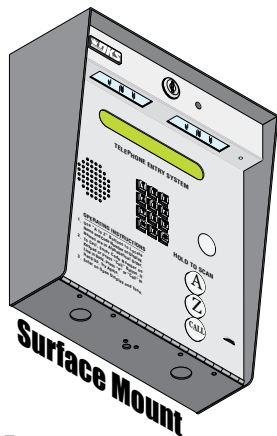

Features

- Can provide service for up to 3000 residents.
- Can store up to 8000 card, transmitter or digital PIN codes.
- System can be programmed with a PC by modem, RS-232 (wireless with different DoorKing wireless adapter kits available), RS-422 (requires 1508-055 adapters), a LAN or WAN connection (requires 1830-185 TCP/IP kit or 1830-186 TCP/IP kit) or via the internet using the Internet Modem Server.
(use of the IM Server is fee based. Visit <http://www.doorking.com/imserver> for more information).
- ONE TOUCH CALLING provides the easiest to use system on the market (does not apply to 1833).
- System keypad will emit DTMF tones after a call is answered allowing the system to be used with auto-attendants, answering machines, etc.
- Directory codes can be set from 1 to 4 digits in length and can be randomly assigned.
- Transaction buffer stores the last 8000 events and has its own backup power source to retain memory during power outages.
- View LIVE transactions.
- 31-security levels total (security level 00 always denies entry, security level 01 always admits entry), with 29 programmable security levels, each with four time zones allows you to control and restrict user access as needed.
- Programmable holiday schedule.
- Facility codes can be enabled or disabled. Store up to 10 different facility codes.
- True Anti-Pass Back feature.
- Up to 255 programmable area codes (Rev E and higher boards only) allow the system to be used in areas requiring 10 and 11-digit dialing.
- Three internal relays allow the system to control a main entry point plus two additional entry points.
- System can be expanded to control up to 24 entry points in addition to the main entry point. Expansion boards are required (one for each additional entry point) and are not included with the system. Expansion boards also provide output for door ajar and forced entry alarms.
- Optional elevator control board(s) can control up to four elevators with each elevator serving up to 64 floors.
- System will interface with selected models of DKS DoorKing vehicular gate operators to provide gate operator information and data (requires a Expansion board for each gate operator that is to send data to the system).
- Available in surface, flush or wall mount styles (1833 available in surface or flush mount only).

Included with the system is an extra random keyed cabinet lock. If desired, for added security against unauthorized entry into the system, the standard lock may be replaced with the random lock.
Note: DoorKing cannot replace this specific lock or keys if lost.

DoorKing, Inc. reserves the right to make changes in the products described in this manual without notice and without obligation of DoorKing, Inc. to notify any persons of any such revisions or changes. Additionally, DoorKing, Inc. makes no representations or warranties with respect to this manual. This manual is copyrighted, all rights reserved. No portion of this manual may be copied, reproduced, translated, or reduced to any electronic medium without prior written consent from DoorKing, Inc.

TABLE OF CONTENTS

Important Notices	FCC - United States, DOC - Canada	3
General Information	Installation Guidelines and Safety Information	4
SECTION 1 - INSTALLATION		5
1.1 General Installation		5
1.1.1	Remove Components from Enclosure	6
1.2.1	Install Enclosure	7
1.2 Surface Mount Dimensions		8
1.2.1	Surface Mount Recess Kit Dimensions and Installation	9
1.3 Flush Mount Dimensions		10
1.3.1	Flush Mount Kit Dimensions and Installation	11
1.3.2	Flush Mount Surface Mounting Kit Dimensions and Installation	12
1.3.3	Self-Standing Lighted Kiosk Dimensions and Installation	13
1.4 Wall Mount Dimensions		14
1.5 Memory Chip Replacement		15
1.6 Postal Lock Installation		16
SECTION 2 - WIRING		17
2.1 Wiring Guidelines		17
2.1.1	Power	17
2.1.2	Wire Runs	17
2.1.3	Grounding	18
2.1.4	Surge Suppression	18
2.1.5	Expansion Boards and Elevator Control	18
2.1.6	Ferrite Filter	18
2.2 Terminal Descriptions		19
2.3 Telephone Entry System Wiring		20
2.3.1	ALL telephone Entry Systems - No Tracker Expansion Boards	20
2.3.2	Hardwired Tracker Expansion Boards	21
2.3.3	Tracker Expansion Boards using Wireless Communication	22
2.4 PC Connection Options		23
2.4.1	Phone Modem Connection	23
2.4.2	Direction Connection using the Circuit Board's RS-232 Terminal	23
2.4.3	RS-232 Terminal using RS-422/USB Connection	23
2.4.4	RS-232 Terminal using Wireless Connection	24
2.4.5	RS-232 Terminal using TCP/IT Converter LAN Connection	24
2.4.6	RS-232 Terminal using TCP/IT Converter WAN Connection	24
2.4.7	DoorKing DKS Internet - Modem Server (IM Server)	24
SECTION 3 - PROGRAMMING		25
3.1 General Programming Information		25
3.1.1	Programming from a PC	25
3.1.2	Programming from the Telephone Entry System Keypad	25
3.1.3	System Memory Chip Identification	26
3.2 Setup Telephone Entry System for PC Programming		26
3.2.1	Master Code	26
3.2.2	Number of Area Codes Allowed	27
3.2.3	Call-Up Operation when Interfacing with DoorKing 1816 or 1820 Systems	27
3.2.4	Resident Elevator Button Relay Time	27
3.2.5	"Tone Open" Sound ON or OFF	27
3.2.6	RS-232 Speed Setting	28
3.2.7	Switch Input Feature	28
3.2.8	Elevator Control Feature	28
3.2.9	Single or Multiple Systems	28
3.2.10	IM Server Client System Phone Number or System ID Number	29
3.2.11	Re-Program Memory Size, with/without Cards and Anti-Pass Back	29
Overview for System Keypad Programming		30
3.3 General Programming using the System Keypad		31
3.3.1	Relay Strike Time	31
3.3.2	Talk Time	31
3.3.3	Tone Open Numbers	32
3.3.4	Switch Input Relay(s) Activation	32
3.3.5	Touch-Tone / Rotary-Dial	33
3.3.6	Rotary-Dial 9 Relay(s) Activation	33
3.4 Programming Letters, Numbers and Messages		34
3.4.1	Programming Letters, Numbers from Keypad	34
3.4.2	Programming the User Message - 1835 System	35
3.4.3	Programming the Instruction Message - 1835 System	36
3.4.4	Programming the User Message - 1837 System	37
3.4.5	Programming the Instruction Message - 1837 System	38

Required System Keypad Programming

System Keypad Programming when NOT using a PC

TABLE OF CONTENTS

↓ System Keypad Programming when NOT using a PC	3.5 Programming Phone Numbers and Names	39	
	3.5.1	Programming the Directory Code Length	40
	3.5.2	Programming Directory Codes with 7-Digit Phone Number - NO Area Code	40
	3.5.3	Programming Area Codes	41
	3.5.4	Programming Directory Codes with Phone Numbers that use Area Codes	41
	3.5.5	Programming Names - 1835 and 1837 Systems Only	41
	3.5.6	Deleting Individual Phone Numbers	42
	3.5.7	Delete Names - 1835 and 1837 Systems Only	42
	3.5.8	Delete Area Codes	43
	3.5.9	Delete phone Numbers - 1835 and 1837 Systems Only	43
	3.5.10	PBX Line Access Code Programming	43
	3.5.11	Touch-Tone Dial Pause	43
	3.6 Programming Device Codes - 1833, 1835, 1837 Only	44	
	3.6.1	Programming Five-Digit Device Codes	44
	3.6.2	Deleting Device Codes	44
	3.6.3	Enabling Facility Codes	44
	3.6.4	Programming Facility Codes	44
	3.7 Programming Four-Digit Entry Codes	45	
3.7.1	Programming Four-Digit Entry Codes	45	
3.7.2	Delete Entry Codes	45	
3.7.3	Entry Code Ranges	45	
3.8 Anti-Pass Back	46		
3.8.1	Programming the Anti-Pass Back Mode	46	
3.8.2	Re-Sync All Devices	46	
3.8.3	Re-Sync Individual Devices	46	
3.8.4	Reset Facility Counter	46	
SECTION 4 - ADJUSTMENTS		47	
4.1 Speaker Volume, Microphone and Feedback	48		
4.2 LCD Display Contrast - 1835 and 1837	48		
4.3 Back-Lite Cutoff	48		
4.4 Master Code Switch	48		
4.5 Ring Pin Jumper	49		
4.6 Relay 2 Jumper	49		
4.7 Auto - 1816 Interface Jumper	49		
4.8 HF - HS Jumper	49		
SECTION 5 - SYSTEM OPERATING INSTRUCTIONS		50	
5.1 Guest Instructions	50		
5.2 Resident Instructions	51		
5.2.1	Responding to a Guest Call	51	
5.2.2	Using an Entry Code	51	
5.3 System Administrator	52		
5.3.1	Connecting to the Telephone Entry System from a Remote Location	52	
5.3.2	Expansion Board Override HOLD OPEN Command	52	
5.3.3	Relay Check	52	
5.3.4	Time and Date Check	52	
5.4 Miscellaneous Operating Instructions	53		
5.4.1	Talk Time	53	
5.4.2	Telephone Line Sharing	53	
5.4.3	Connection to a PBX System	53	
5.4.4	Areas with 10-Digit Dialing	53	
SECTION 6 - MAINTENANCE		54	
6.1 Troubleshooting	54-55		
6.1.1	RS-232 Test	56	
6.1.2	Wiegand Test - 1835 and 1837 Systems Only	56	
6.1.3	Elevator Control Board(s) Hardware Test - 1835 and 1837 Systems Only	56	
6.1.4	Elevator Board / Floor Hardware Test - 1835 and 1837 Systems Only	57	
6.1.5	Automatic Hang-up Options - 1835 and 1837 Systems Only	57	
6.1.6	Modem Output Level Adjustment	57	
6.1.7	Display IM Server Client Phone Number or System ID Number	58	
6.1.8	Test Connection to IM Server Client	58	
6.1.9	Turn IM Server Client Mode ON or OFF	58	
6.2 Accessories	59		
Wiring Schematics 1833, 1835 and 1837	60-62		
SECTION 7 - LOG TABLES		63	
7.1 Programming Information Tables	63		
7.1.1	10 Area Codes	63	
7.1.2	255 Area Codes	63-65	
7.2 Resident Information	66		
RESIDENT INSTRUCTION SHEET		67	

Important Notices

FCC – United States

This equipment has been tested and found to comply with the limits for a class A digital device, pursuant to Part 15 of the FCC Rules and Regulations. These limits are designed to provide reasonable protection against harmful interference when the equipment is operated in a commercial environment. This equipment generates, uses, and can radiate radio frequency energy and, if not installed and used in accordance with the instruction manual, may cause harmful interference to radio communications. Operation of this equipment in a residential area is likely to cause harmful interference in which case the user will be required to correct the interference at his own expense.

FCC Registration Number: **DUF6VT-12874-0T-T**

DOC - Canada

The Canadian Department of Communications label identifies certified equipment. This certification means that the equipment meets certain telecommunications network protective, operational, and safety requirements. The Department does not guarantee the equipment will operate to the users satisfaction.

Before installing this equipment, users should ensure that it is permissible to be connected to the facilities of the local telecommunications company. The equipment must also be installed using an acceptable means of connection. The customer should be aware that compliance with the above conditions may not prevent degradation of service in some situations.

Repairs to certified equipment should be made by an authorized Canadian maintenance facility designated by the supplier. Any repairs or alterations made by the user to this equipment, or equipment malfunctions, may give the telecommunications company cause to request the user to disconnect the equipment.

Users should ensure, for their own protection, that the electrical ground connections of the power utility, telephone lines, and internal metallic water pipe system, if present, are connected together. This precaution may be particularly important in rural areas.

CAUTION: Users should not attempt to make such connections themselves, but should contact the appropriate electric inspection authority, or electrician, as appropriate.

DOC Registration Number: **1736 4507 A**

Notice:

The Load Number (LN) assigned to each terminal device denotes the percentage of the total load to be connected to a telephone loop which is used by the device, to prevent overloading. The termination on a loop may consist of any combination of devices subject only to the requirement that the sum of the load numbers of all the devices does not exceed 100.

Notice:

DoorKing does not provide a power transformer on units sold outside of the United States. Use only transformers that are listed by a recognized testing laboratory to power the telephone entry system. **An Inherently Protected Transformer must be used to power this device.** 1833, 1834 and 1835 systems require a 16.5-volt, 20 VA transformer. The model 1837 requires a 16.5-volt, 40 VA transformer.

Listing:

This product has been tested to and found to be in compliance with the UL 294 Safety Standard by Intertek Testing Services NA Inc. (a Nationally Recognized Testing Laboratory) and is ETL listed.

General Information

- Prior to beginning the installation of the telephone entry system, we suggest that you become familiar with the instructions, illustrations, and wiring guidelines in this manual. This will help insure that you installation is performed in an efficient and professional manner.
- The proper installation of the telephone entry panel is an extremely important and integral part of the overall access control system. Check all local building ordinances and building codes prior to installing this system. Be sure your installation is in compliance with local codes.
- When used to control a door or pedestrian gate, try to locate the telephone entry system as near as possible to the entry point. The unit should be mounted on a rigid wall to prevent excessive shock and vibration from closing doors or gates. Continuous vibration and shock from slamming doors or spring-loaded pedestrian gates will damage the circuit board. **Under no circumstances should the unit be mounted directly to a moving door or gate.**
- **ADA mounting requirements for door control (Ref: ICC/ANSI A117.1-2009).** The requirements below apply only when the telephone entry system is being used to control entry through a public door only. If this system is used to control entry through a vehicular gate or private entrance, the dimensions noted below do not apply.
 - 1. Unobstructed Forward Reach.** Where a clear floor or ground space allows only a forward approach to an object and is unobstructed, mounting height shall be a minimum of 15 inches (381 mm), and a maximum of 48 inches (1.22 m), above the floor or ground to the operable controls.
 - 2. Obstructed High Forward Reach.** If the high forward reach is over an obstruction greater than 20 inches, but less than 25 inches, mounting height shall be a maximum of 44 inches (1.12 m) above the floor or ground to the operable controls.
 - 3. Unobstructed Side Reach.** Where a clear floor or ground space allows a parallel approach to an object and the side reach is unobstructed, and the edge of the clear floor space is 10 inches (255 mm) maximum from the object, mounting height shall be a minimum of 15 inches (380 mm), and a maximum of 48 inches (1.22 m), above the floor or ground to the operable controls.
 - 4. Obstructed High Side Reach.** If the side reach is over an obstruction greater than 10 inches, but less than 24 inches, mounting height shall be a maximum of 46 inches (1.17 m) above the floor or ground to the operable controls.
- **When used to control a vehicular gate with an automatic gate operator, the telephone entry system must be mounted a minimum of ten (10) feet away from the gate and gate operator, or in such a way that a person cannot operate the entry system and/or touch the gate or gate operator at the same time.**
- Be sure that the system is installed so that it is not directly in the traffic lane. Goose neck mounting post and kiosks work well for these type systems. When planning where to locate the system, take into consideration traffic lane layouts, turn around lanes for rejected access, conduit runs, power availability, etc.
- Environmental factors must also be taken into account. Surface mount units are designed for direct outdoor installations, however it is preferable to protect them from direct exposure to driven rain or snow whenever possible. Flush mount units must be protected from direct exposure to the elements.
- This telephone entry system contains a number of static sensitive components that can be damaged or destroyed by static discharges during installation or use. Discharge any static prior to removing the circuit board from the lobby panel by touching a proper ground device.
- **Instruct the end user to read and follow these instructions. Instruct the end user to never let children play with or operate any access control device. This Owner's Manual is the property of the end user and must be left with them when installation is complete.**

SECTION 1 - INSTALLATION

Prior to installing the telephone entry system, we suggest that you become familiar with the instructions, illustrations, and wiring guidelines in this manual. This will help insure that you installation is performed in an efficient and professional manner.

Order your telephone line to be installed at least two weeks prior to the planned telephone entry system installation date.

This will assure that a phone line is available when the unit is installed. The telephone company will require the following information from you:

Type:	Touch Tone, Loop Start
Ringer Equivalence:	0.0 A
Jack Type:	RJ11C
FCC Registration (US):	DUF6VT-12874-OT-T
DOC (Canada):	1736 4528 A
Electrical Listing:	Complies with UL 294 - ETL Listed

Caller ID: You may want to order **caller ID blocking** from the telephone company for the entry system phone line. Without caller ID blocking, residents with the proper phone equipment **WILL BE ABLE** to identify the telephone number that the telephone entry system is installed on. This may or **MAY NOT** be desirable.

Call Waiting: Residents may order call waiting from their local telephone company **AFTER** the system has been installed. They can avoid missing calls coming from the telephone entry system while they are using their phone (No busy signal).

1.1 General Installation

There are 3 different styles of the 1830 telephone entry system (Surface, flush and wall mounts), and many different ways to mount them (On a wall, in a wall, attached to a architectural style post, kiosk, etc). Specific models will vary a little from the general installation described in this manual and minor modifications will need to be made depending on which one of the entry system models has been chosen and where it will be mounted. They will **ALL** need a telephone line, power and communication wires run to them in conduit or inside a architectural style post. Feed all of the wires through the back or bottom of the entry system using the existing knock-outs provided in the enclosures. **DO NOT** make any new holes in the enclosure to feed wires through. Keep **ALL** the entry system's wires away from any existing high voltage power wires a minimum of 6" to help prevent any noise and hum pickup in the system's phone line. The system **MUST** also be **properly grounded** to function correctly.

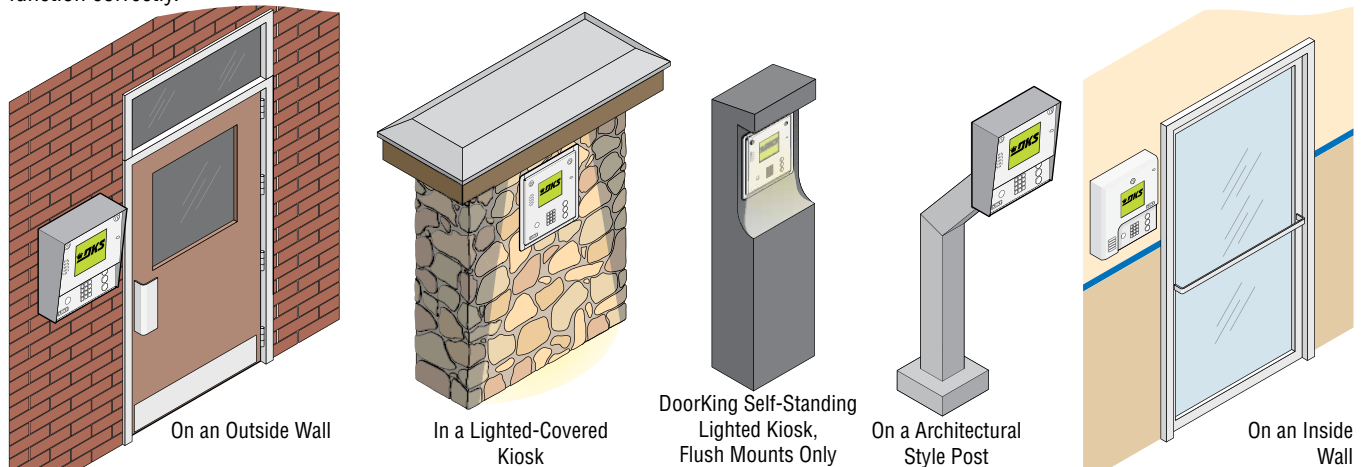

WARNING If this telephone entry system is used to control a vehicular gate with an automatic gate operator, the telephone entry system must be mounted a minimum of ten (10) feet away from the gate and gate operator, or in such a way that the user cannot come into contact with the gate or gate operator when using this entry system.

The telephone entry system contains a number of static sensitive components that can be damaged or destroyed by static discharges during installation. **Discharge any static prior to removing the circuit board by touching a proper ground device.** GREAT care must be taken after removing the components from the enclosure to protect them throughout the installation. Carelessness on your part is **NOT** covered under warranty.

Make sure **ALL** dirt, metal or wood debris is removed from inside the enclosure after mounting it. A thorough cleaning of the enclosure is needed before re-installing the components back into the system and wiring it. Any debris left inside could damage the control board and cause the telephone entry system to malfunction during operation.

Included with the system is an extra random keyed cabinet lock. If desired, for added security against unauthorized entry into the system, the standard lock may be replaced with the random lock. Note: DoorKing cannot replace this specific lock or keys if lost.

1.1.1 Remove Components from Enclosure

There are 3 different styles of the 1830 telephone entry system - surface, flush and wall mount. **Components in the flush and wall mounts will vary a little from this.**

1. Disconnect the two ribbon cables from the circuit board (Only one ribbon cable in some models).
2. Remove the two screws from the upper corners of the circuit board.
3. **GENTLY** remove the circuit board by pulling it out of the main terminal.
4. Remove the two screws from the main terminal and remove the ground wire locknut.
5. Remove four locknuts from the faceplate hinge (5 for the wall mount).
6. Remove the faceplate, main terminal (still wired), ribbon cables and the circuit board, store them in a **Safe Place** until they need to be re-installed.

Discharge any static BEFORE removing the circuit board by touching a proper ground device.

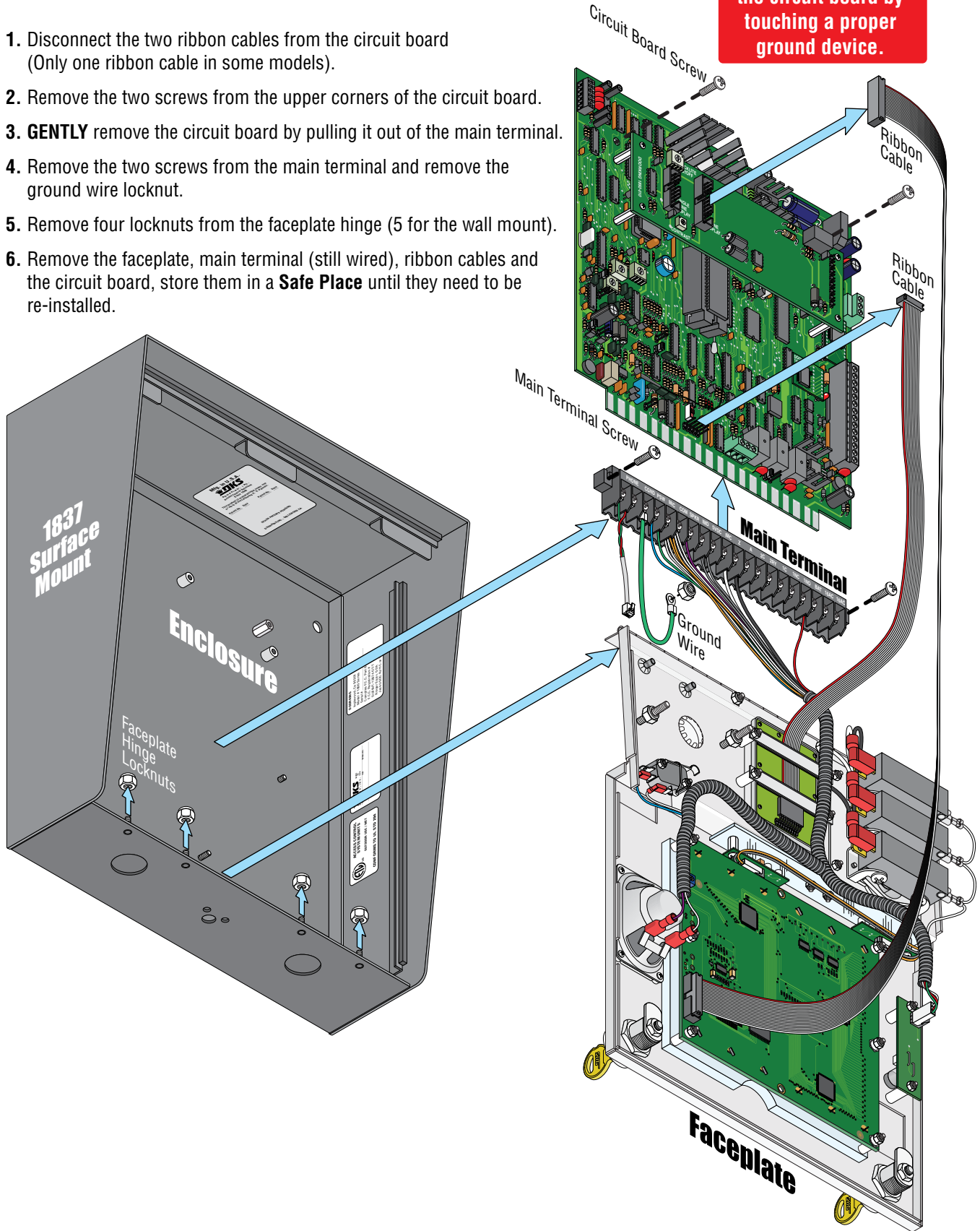

1.1.2 Install Enclosure

There are 3 different styles of the 1830 telephone entry system - surface, flush and wall mount. The illustrations below show typical installations but specific installations can vary from this.

1. Mount the enclosure using the mounting holes provided in the corners (see sections 1.2, 1.3 and 1.4 for your chosen model dimensions including kit installations). Be sure that mounting screws (Not supplied) do not protrude into the enclosure where they could cause a short on the back of the circuit board. Make any necessary conduit connections through the back or bottom of the enclosure using the existing conduit knock-outs. **DO NOT** make any new conduit holes in the enclosure.
2. Route all wiring through conduit or architectural post (not supplied) into enclosure.
3. Clean out the enclosure. Make sure that all dirt, metal and/or wood debris is removed.
4. Re-install components back into the enclosure (Reverse section 1.1.1 steps on previous page). Use the wiring schematics in the back of this manual to help re-install the components if necessary. **DO NOT** apply any power at this time.

Mount to an Architectural Post

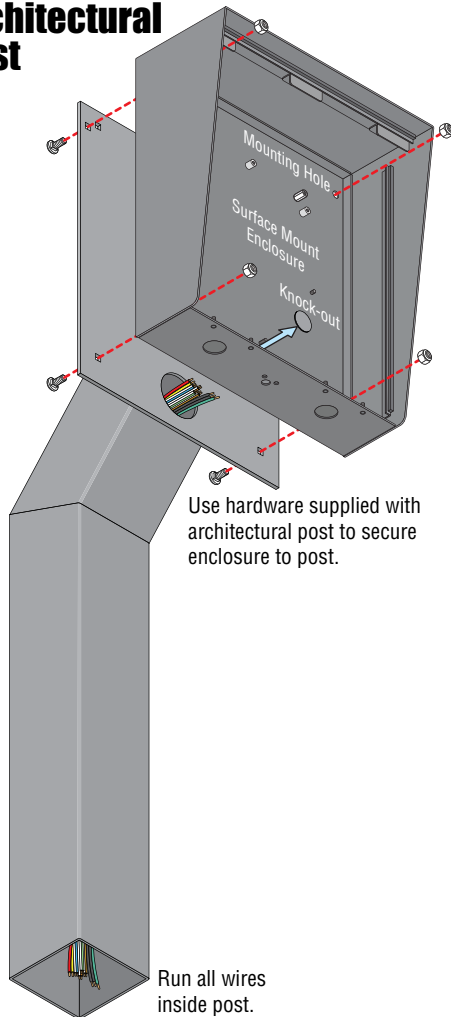

Mount ON a Surface

(See sections 1.2, 1.3.2 and 1.4).

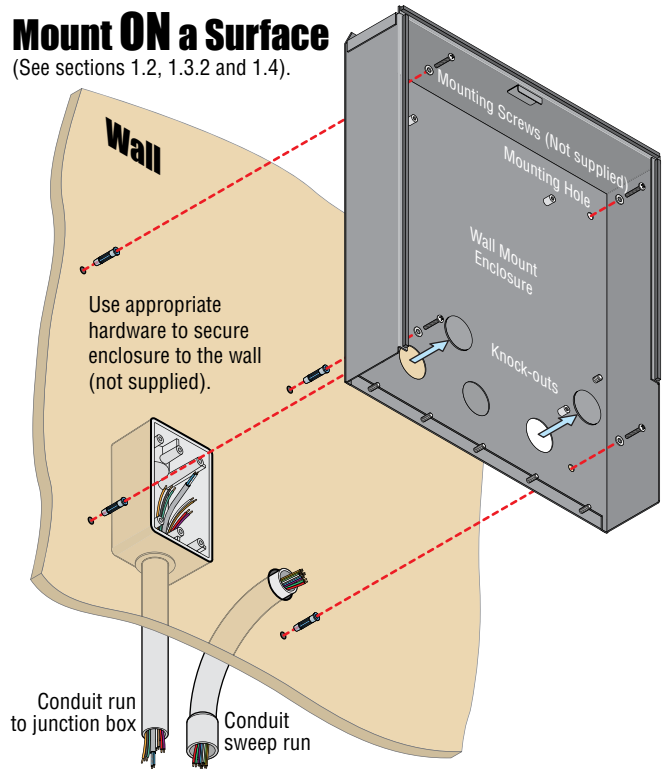

Examples of conduit runs that may be used, depending on how you choose to run the wiring. Some installations will allow the conduit to be run outside the wall and connect to the bottom of the enclosure but this is generally NOT recommended.

Mount IN a Surface

(See sections 1.2.1, 1.3.1 and 1.3.3).

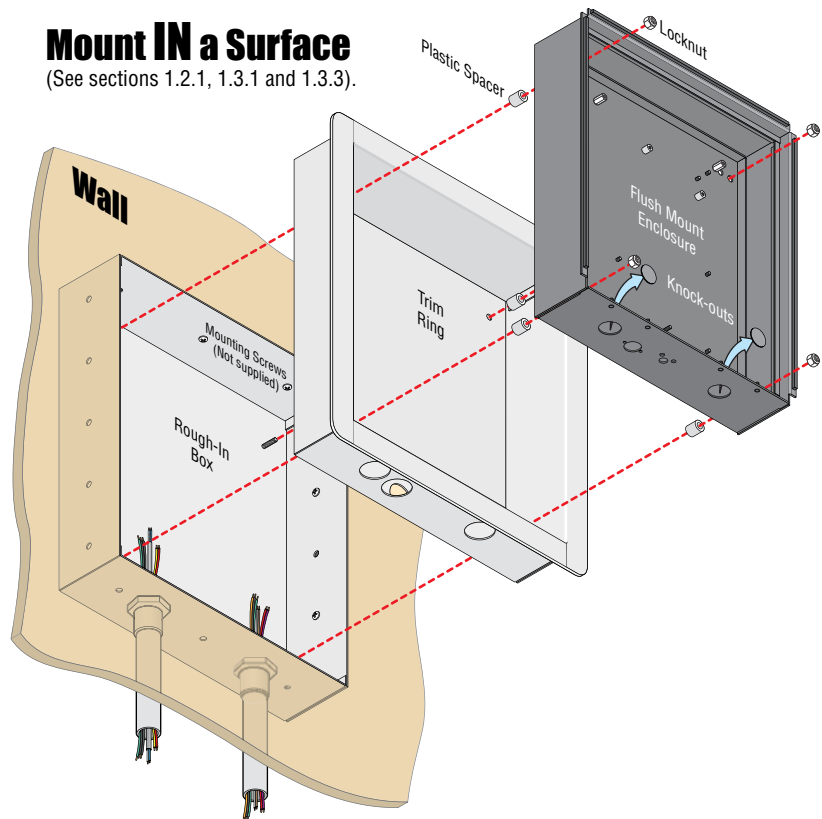

1.2 Surface Mount Dimensions

Surface mount units can be mounted directly to a wall, pilaster, post mounted using a DoorKing architectural style mounting post (P/N 1200-037 and 1200-038) or recessed in a wall (see next page) with the surface mount recess kit (P/N 1803-150). Be sure the unit is mounted securely and is not subject to vibration from closing doors or gates.

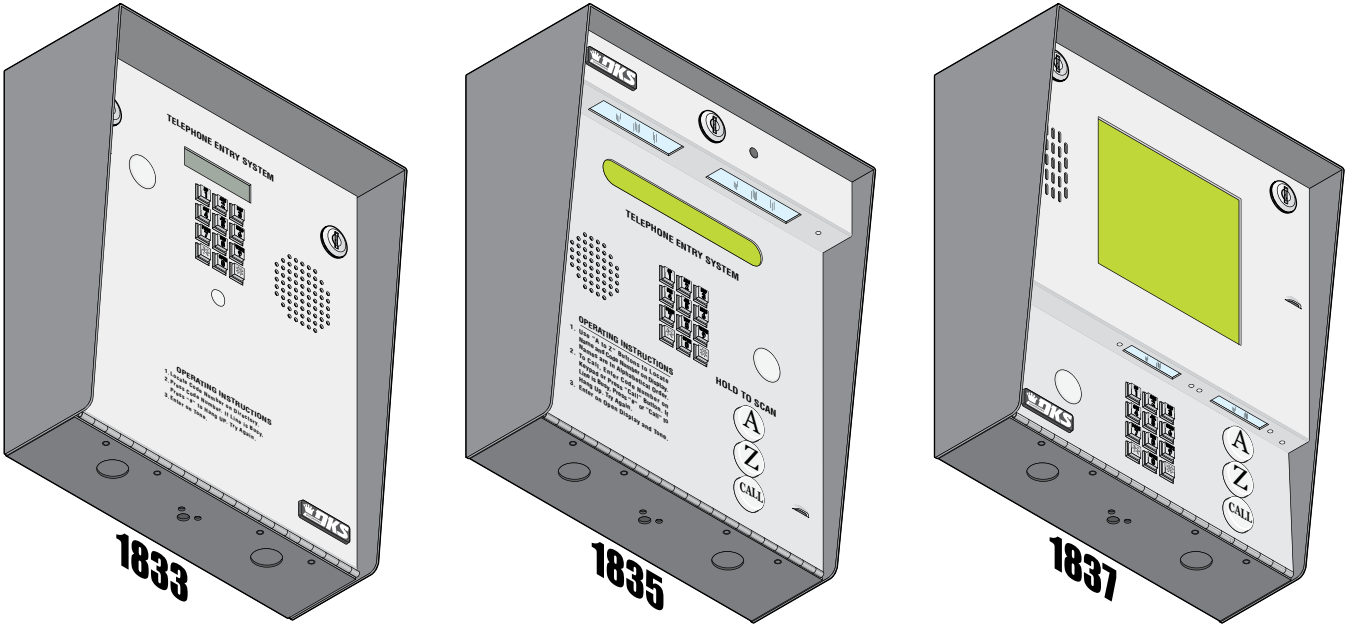

Back View

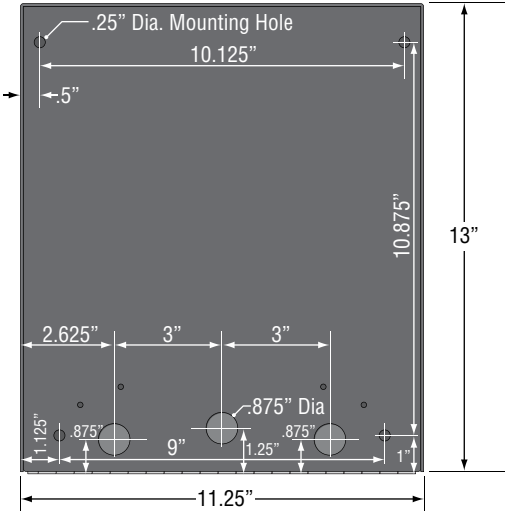

Side View

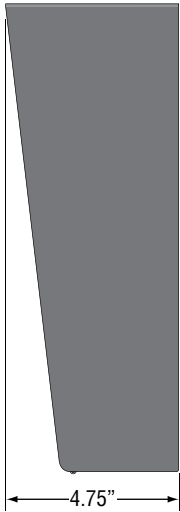

Front View

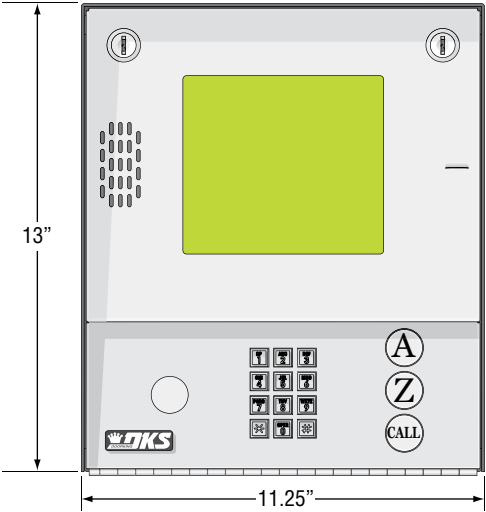

WARNING! If this entry system is used to control a vehicular gate with an automatic gate operator, the entry system must be mounted a minimum of ten (10) feet away from the gate and gate operator, or in such a way that a person cannot operate the entry system and touch the gate or gate operator at the same time.

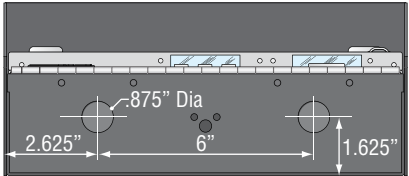

Bottom View

1.2.1 Surface Mount Recess Kit Dimensions and Installation

Surface mount units can be recessed into a wall or pilaster by using the optional surface mount recess kit (P/N 1803-150). This allows for a recessed telephone entry system to have a lighted keypad (except for the 1833) which the flush mount units **DO NOT** have. The recess box gets installed in the wall. Use appropriate hardware (not included) to secure the box in the wall. Run all necessary conduit (not included) to the recess box. Slide the enclosure in the recess box and secure it with the hardware included in the kit. Be sure the unit is mounted securely and is not subject to vibration from closing doors or gates.

WARNING! If this entry system is used to control a vehicular gate with an automatic gate operator, the entry system must be mounted a minimum of ten (10) feet away from the gate and gate operator, or in such a way that a person cannot operate the entry system and touch the gate or gate operator at the same time.

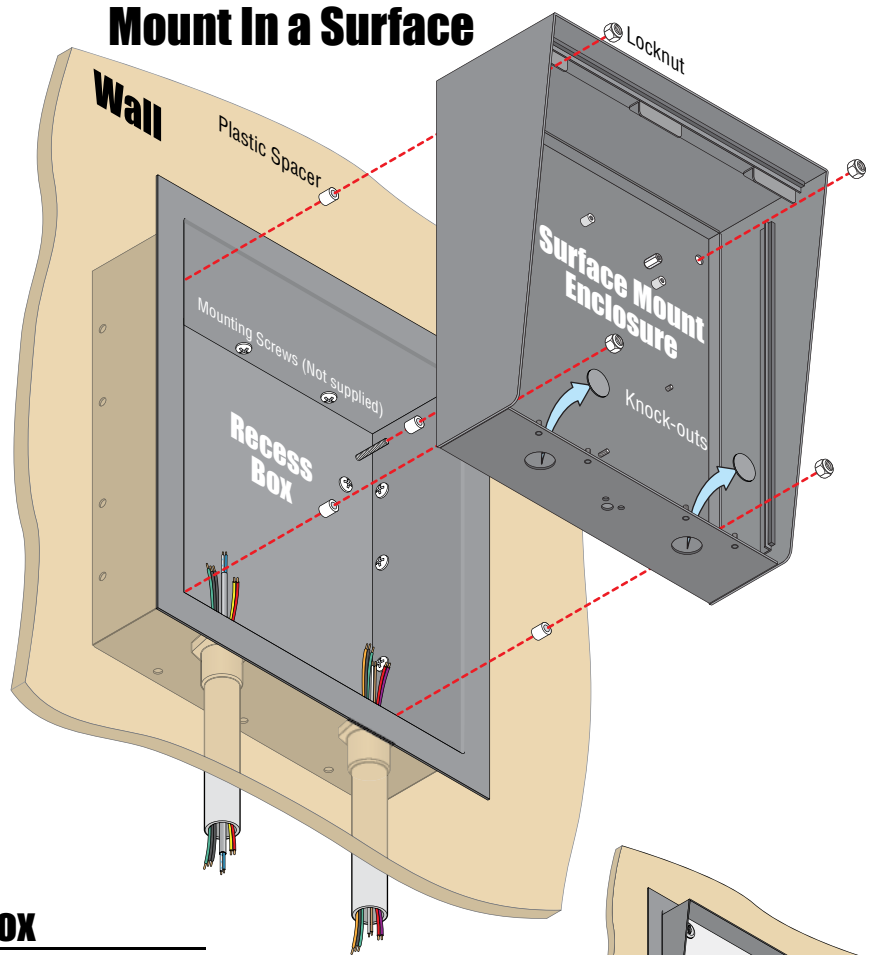

Recess Box

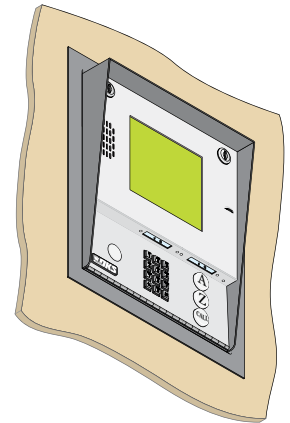
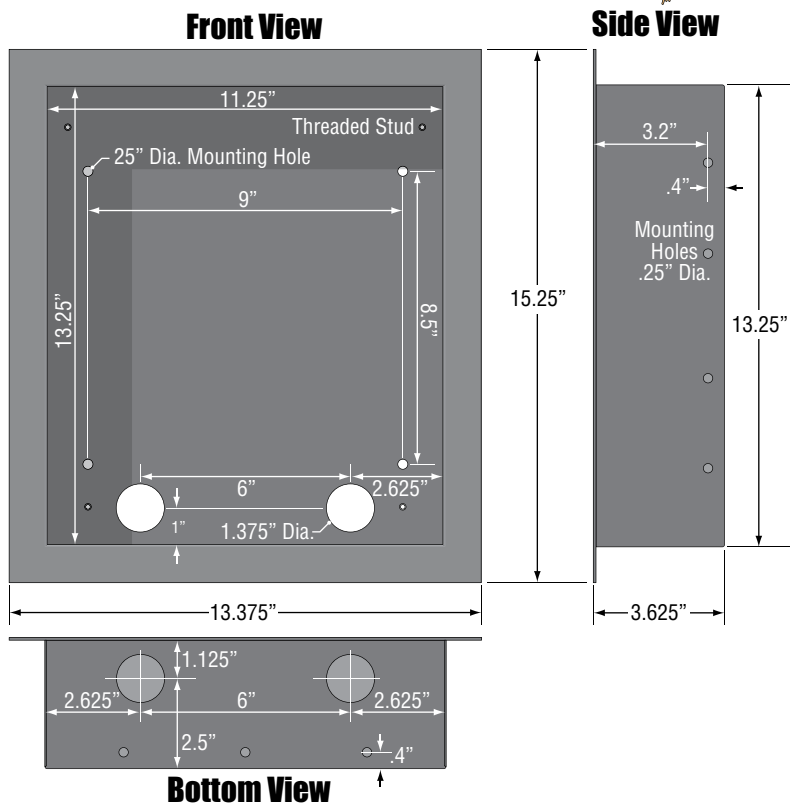

1.3 Flush Mount Dimensions

Flush mount units are installed into a wall with a flush mount kit P/N 1814-165 (stainless) or 1814-166 (gold). Flush mount kits are **NOT INCLUDED** with the flush mount entry system (See next page for flush mount kit dimensions).

DoorKing offers a self-standing lighted kiosk for the flush mount unit ideal for walk-up pedestrian applications P/N 1200-170 (See section 1.3.3 for self-standing kiosk dimensions and installation).

The flush mount units may also be installed on the surface of a wall with a surface mounting kit if desired P/N 1814-152 (silver only). Flush mount surface mounting kits are **NOT INCLUDED** with the flush mount entry system (See section 1.3.2 for flush mount surface mounting kit dimensions).

Flush mount units are installed into a wall/kiosk and can be mounted outside, exposed to the weather. It is preferred that they have limited direct exposure to the weather. We suggest that when they are mounted outdoors, it is in a covered protected area. Be sure the unit is mounted securely and is not subject to vibrations from closing doors or gates.

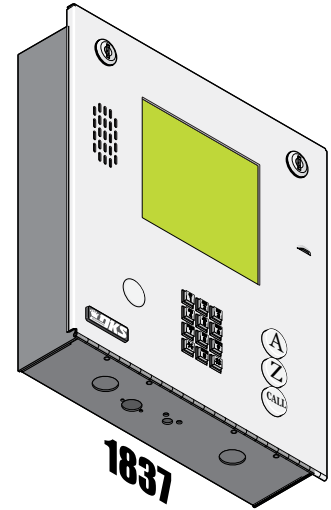
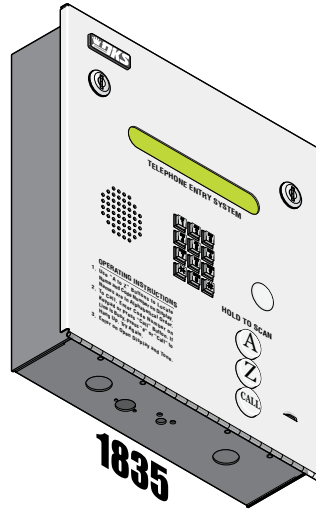
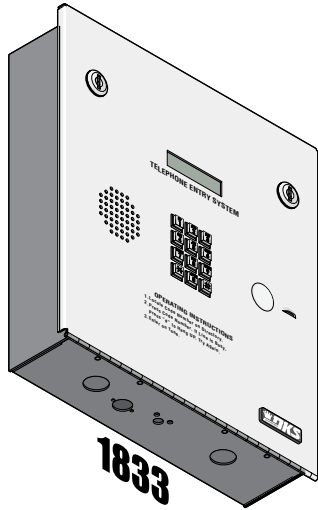

Back View

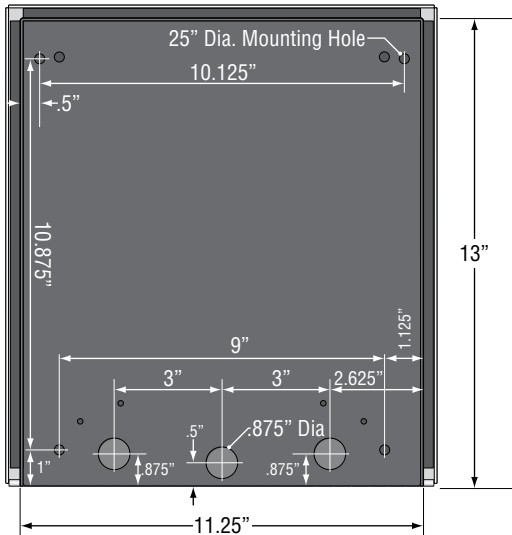

Side View

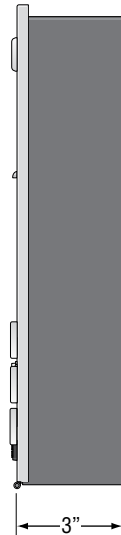

Front View

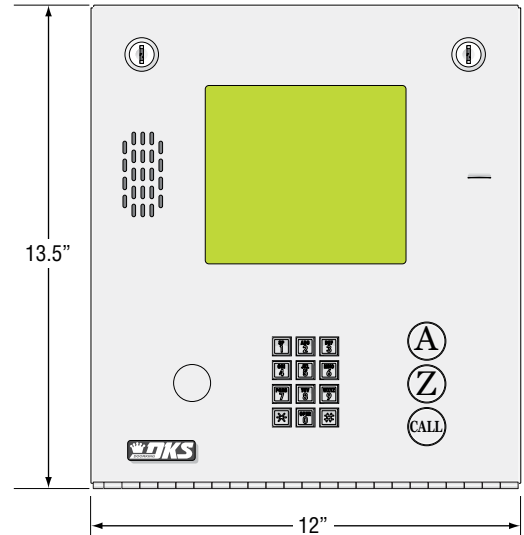

Bottom View

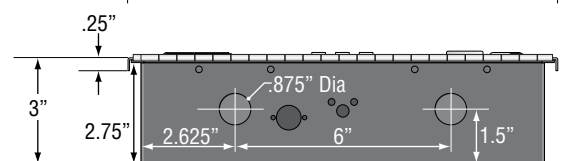

WARNING! If this entry system is used to control a vehicular gate with an automatic gate operator, the entry system must be mounted a minimum of ten (10) feet away from the gate and gate operator, or in such a way that a person cannot operate the entry system and touch the gate or gate operator at the same time.

1.3.1 Flush Mount Kit Dimensions and Installation

The flush mount installation kit has two parts; the rough-in box and the trim ring. The rough-in box is installed in the wall first. Use appropriate hardware (not included) to secure the box in the wall. Run all necessary conduit (not included) to rough-in box. Slide the trim ring into the rough-in box. Slide the enclosure in the trim ring and secure them all together with the hardware included in the kit. Be sure the unit is mounted securely and is not subject to vibration from closing doors or gates. See previous page for flush mount enclosure dimensions.

WARNING! If this entry system is used to control a vehicular gate with an automatic gate operator, the entry system must be mounted a minimum of ten (10) feet away from the gate and gate operator, or in such a way that a person cannot operate the entry system and touch the gate or gate operator at the same time.

Mount In a Surface

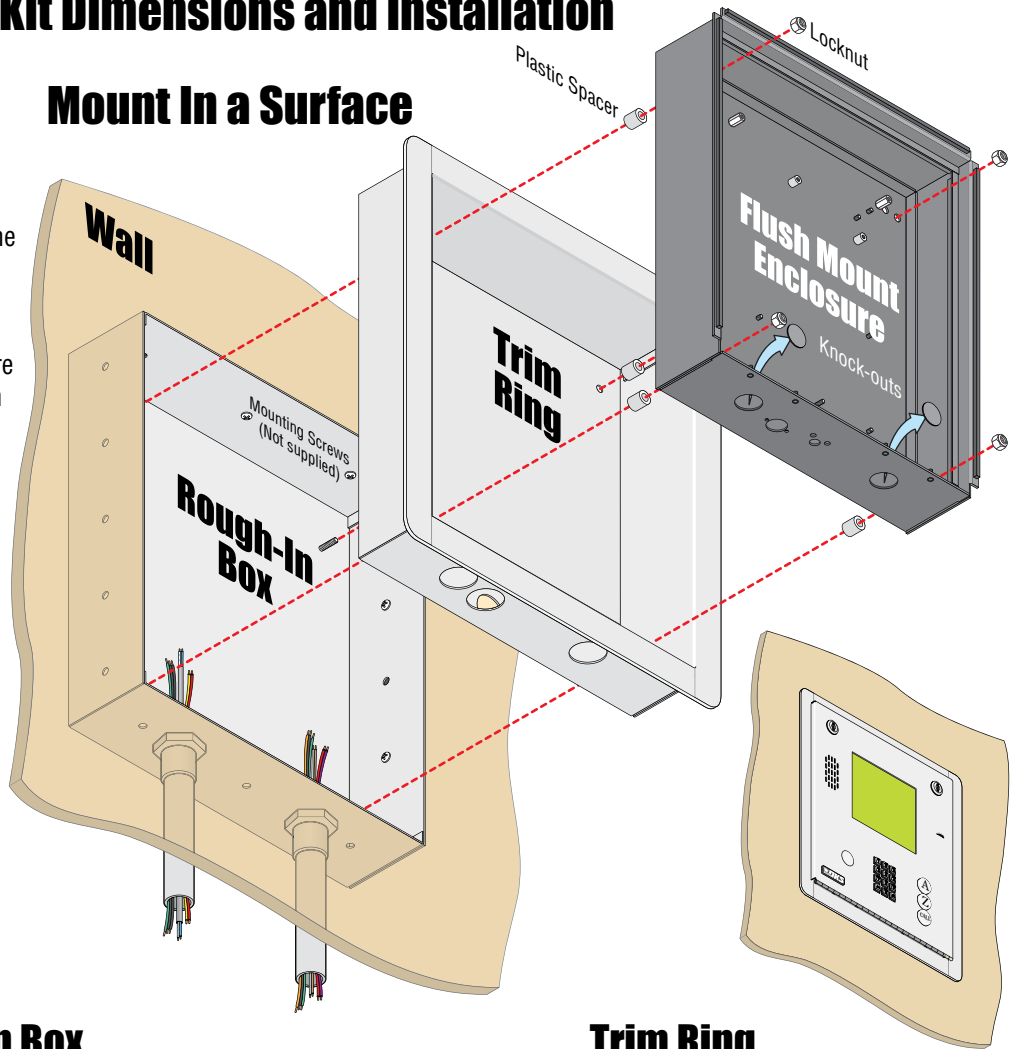

Rough-In Box

Trim Ring

Side View

Front View

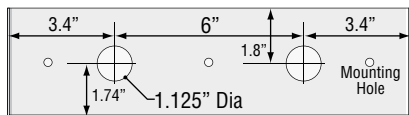
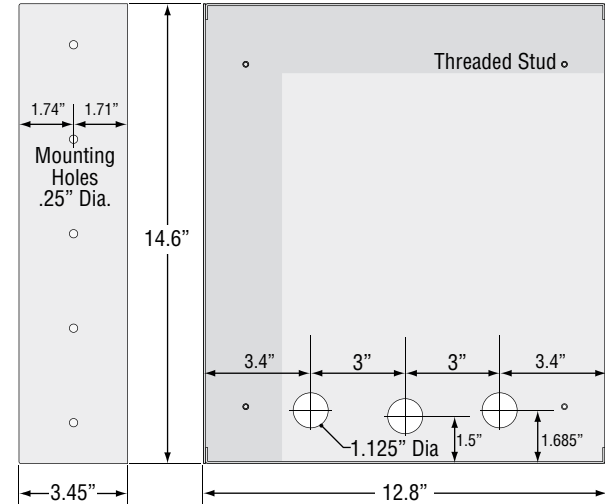

Bottom View

Front View

Side View

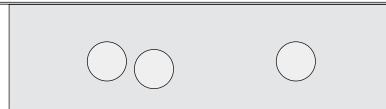
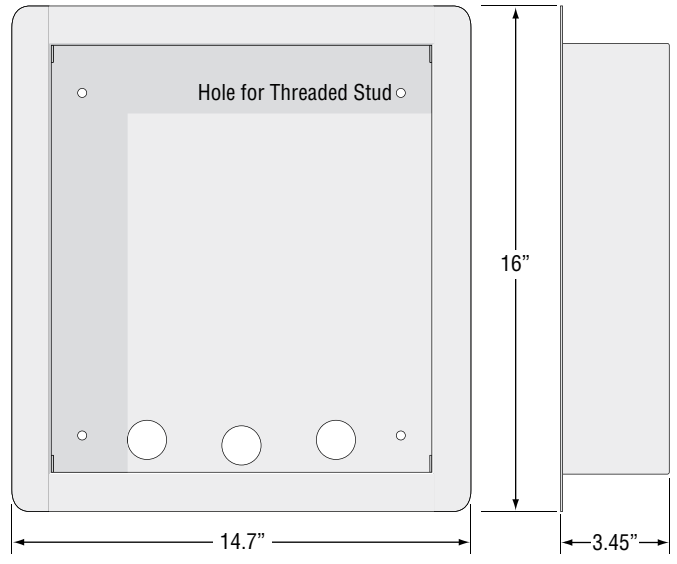

Bottom View

1.3.2 Flush Mount Surface Mounting Kit Dimensions and Installation

Flush mount unit (See section 1.3 for flush mount enclosure dimensions) can be mounted **ON** a wall or pilaster and **NOT IN** the wall by using the optional flush mount surface mounting kit (P/N 1814-152). This is useful when cutting a large hole into a wall or pilaster would be very difficult (marble or granite for example). The flush mount surface mounting kit is a trim ring that fits around the flush mount enclosure. The enclosure and trim ring get installed directly on the wall using appropriate hardware (not included) after running all necessary conduit to the enclosure. Be sure the unit is mounted securely and is not subject to vibration from closing doors or gates

Examples of some small holes in the wall that may be needed, depending on how you choose to run the wiring.

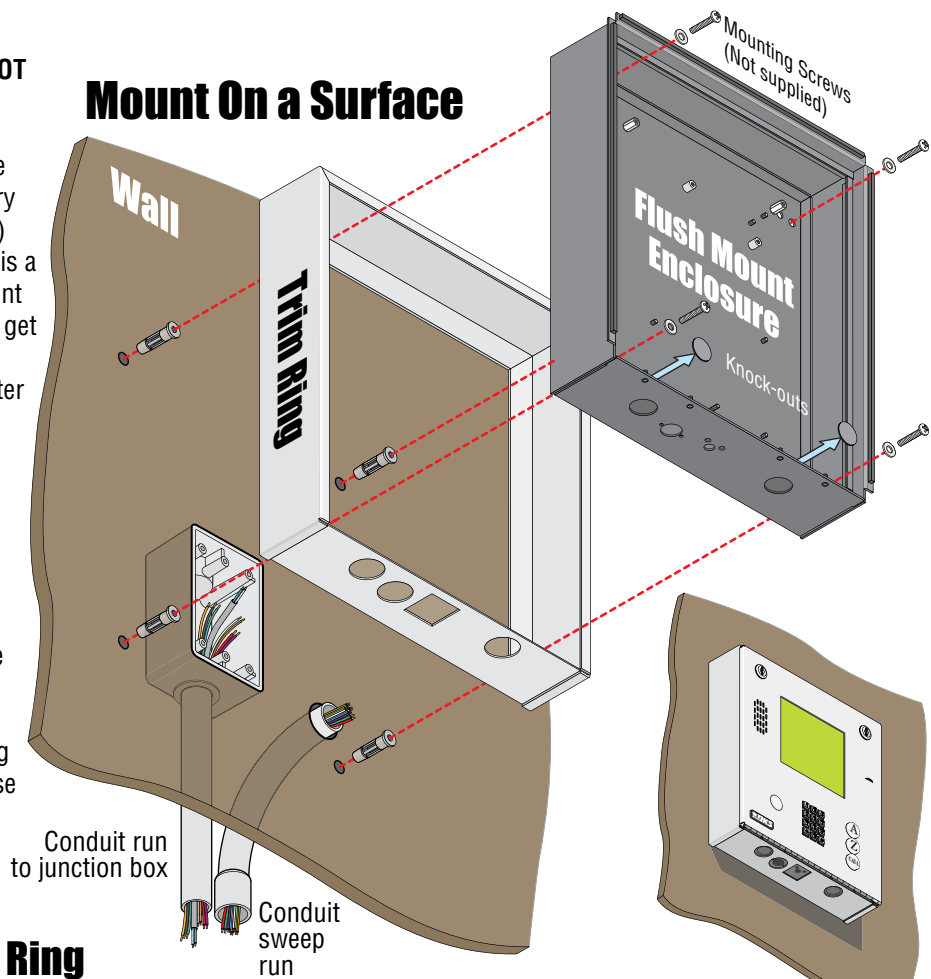

Trim Ring

Front View

Side View

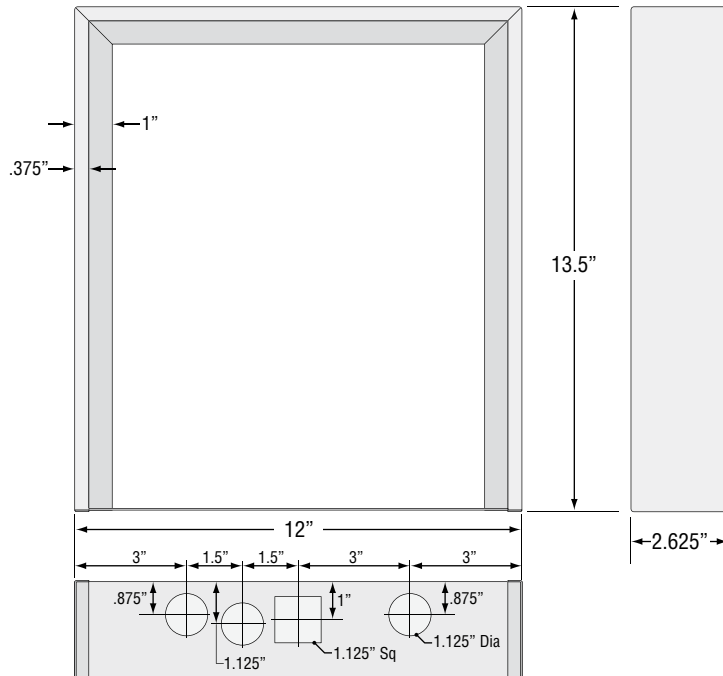

WARNING! If this entry system is used to control a vehicular gate with an automatic gate operator, the entry system must be mounted a minimum of ten (10) feet away from the gate and gate operator, or in such a way that a person cannot operate the entry system and touch the gate or gate operator at the same time.

1.3.3 Self-Standing Lighted Kiosk Dimensions and Installation

The flush mount kit (Sold separately) is installed into the self-standing kiosk (P/N 1200-170) to secure the flush mounts units **ONLY** in place. Secure the rough-in box in the kiosk. Run all necessary wires to rough-in box. Slide the trim ring into the rough-in box. Slide the enclosure in the trim ring and secure them all together with hardware included in the kit.

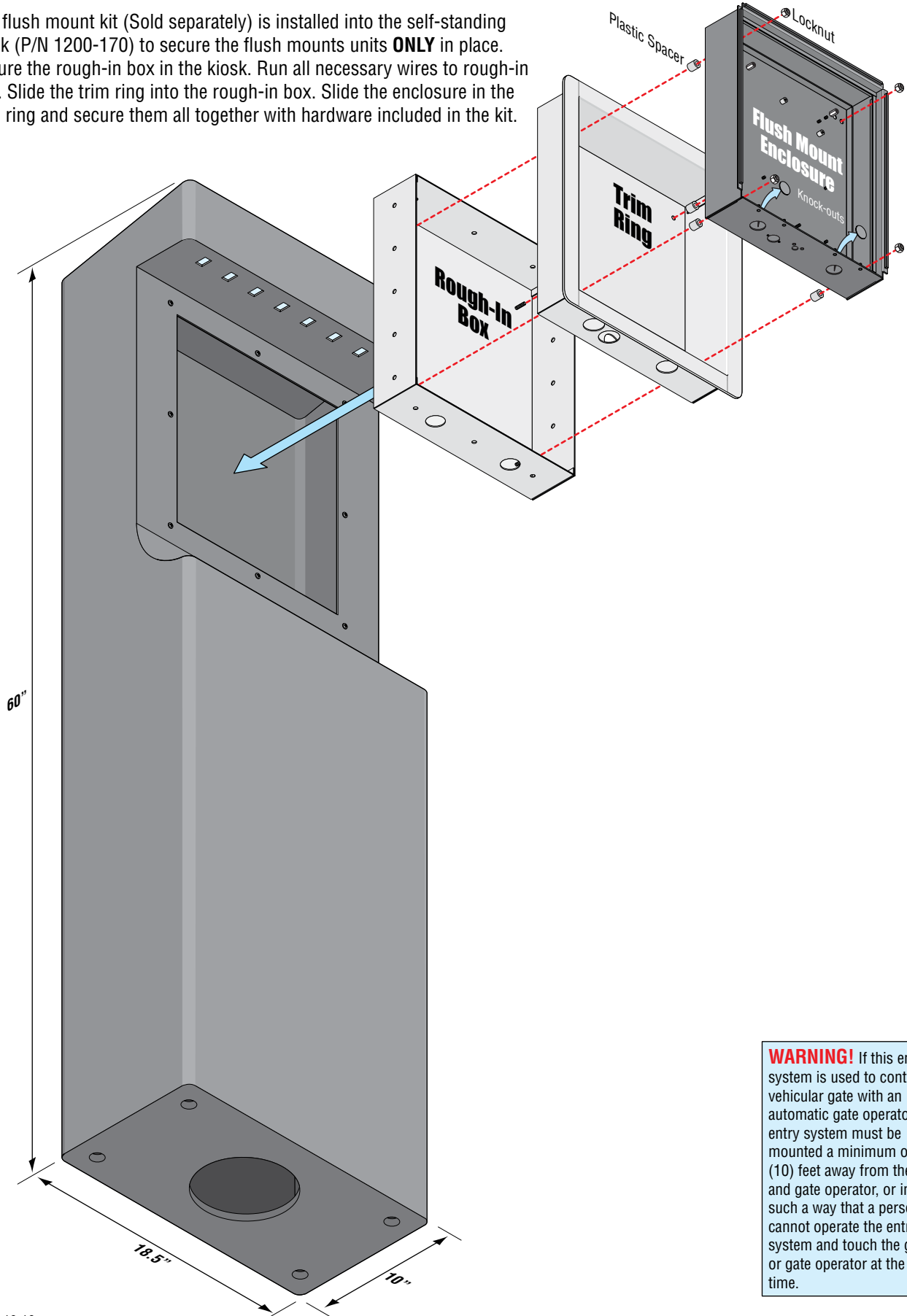

WARNING! If this entry system is used to control a vehicular gate with an automatic gate operator, the entry system must be mounted a minimum of ten (10) feet away from the gate and gate operator, or in such a way that a person cannot operate the entry system and touch the gate or gate operator at the same time.

1.4 Wall Mount Dimensions

Wall mount units are designed to be mounted directly onto a wall without the need of cutting a large hole as is necessary with flush mount units. Be sure the unit is mounted securely and is not subject to vibration from closing doors or gates.

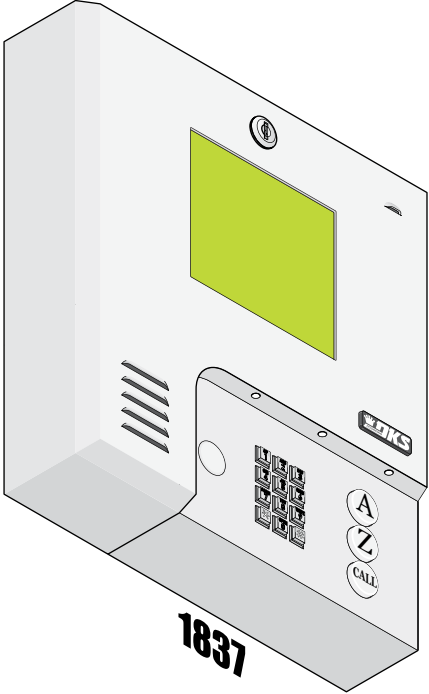
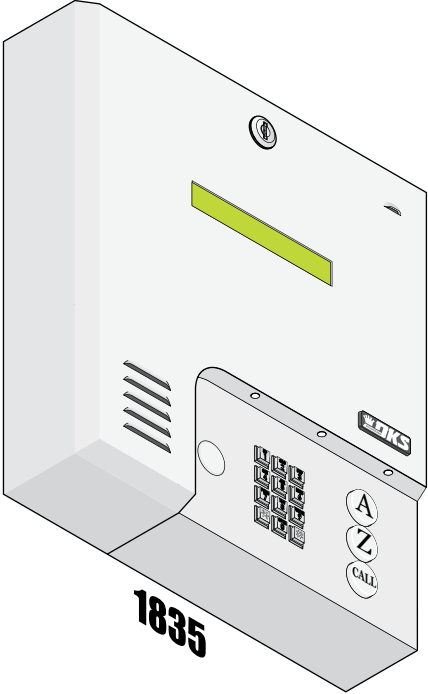

Back View

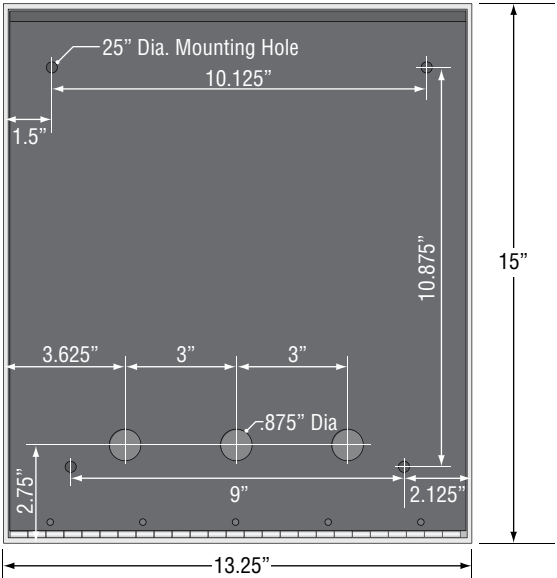

Side View



Front View

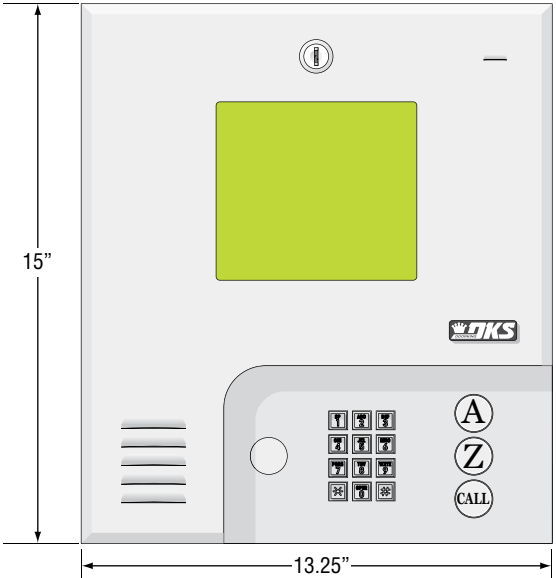

Bottom View

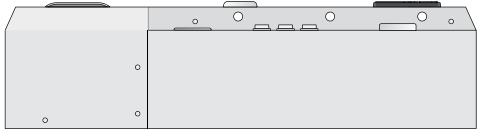

WARNING! If this entry system is used to control a vehicular gate with an automatic gate operator, the entry system must be mounted a minimum of ten (10) feet away from the gate and gate operator, or in such a way that a person cannot operate the entry system and touch the gate or gate operator at the same time.

1.5 Memory Chip Replacement

The 1830 entry system is shipped with the memory chip already installed in the unit. However, if you need to replace the memory chip in the NEW 1830 entry system or replace the memory chips in an OLDER 1830, follow the instructions below. See 3.1.3 Memory Chip Identification for info about the memory chips in older 1830 entry systems.

⚠ CAUTION

Power MUST be OFF to the Circuit Board!!

DO NOT install the memory chip(s) with power to the telephone entry system turned ON. Attempting to install the memory chip(s) with power on will irrevocably damage the chip(s). The memory chip(s) are static sensitive components. Discharge any static electricity from your hands by touching a proper ground device before touching the control board. Handle the memory chip(s) with care, the pins bend easily.

DO NOT install the memory chip(s) UPSIDE DOWN. this will cause permanent damage to the chip(s). Be sure that the memory chip is seated correctly in the socket.

Discharge any static electricity from your hands by touching a proper ground device before installing chip(s)!

1830 Series Circuit Board Memory Chip(s) Location

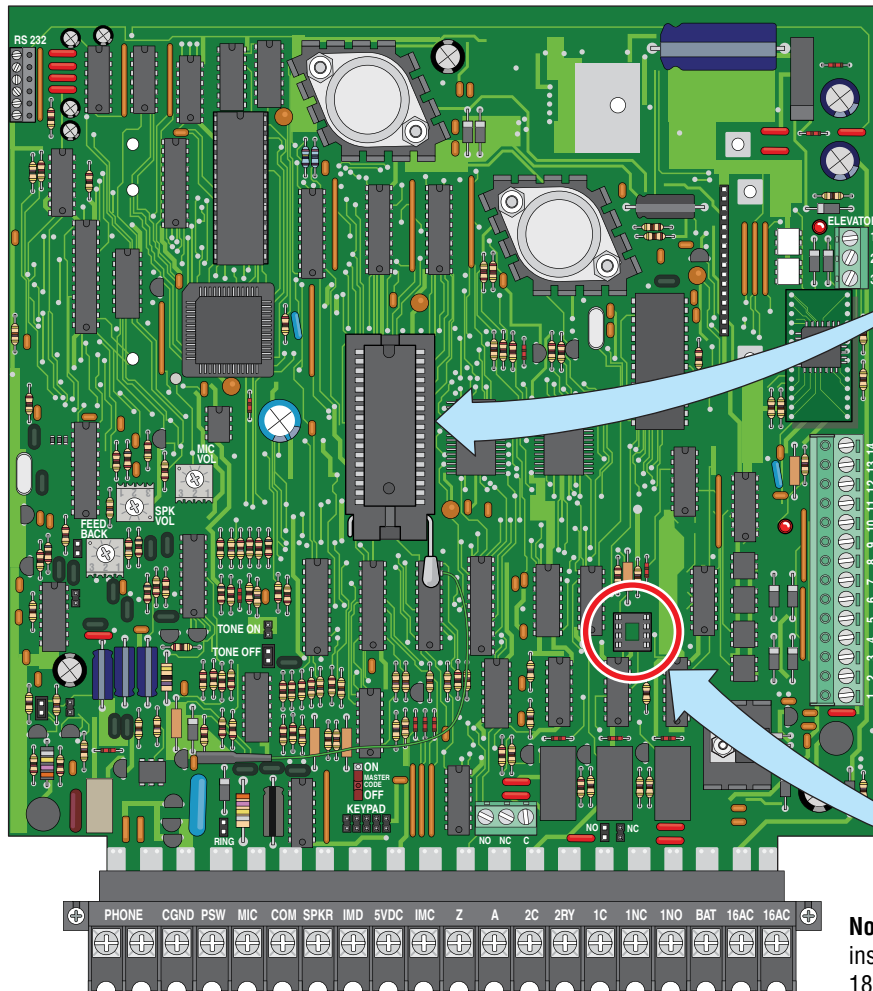

Dimple MUST be at the top of the chip!

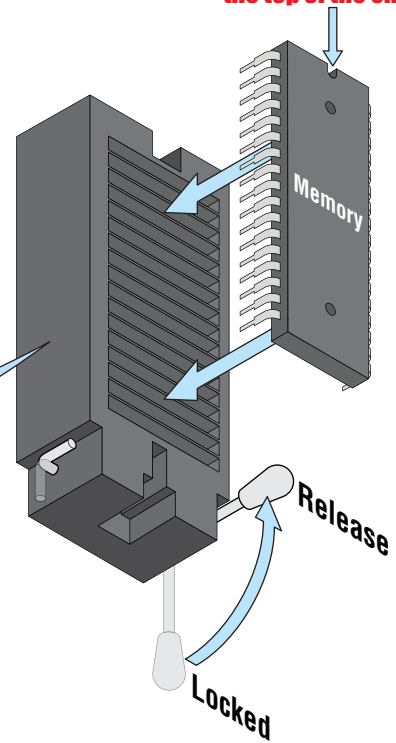

Dimple MUST be at the top of the chip!

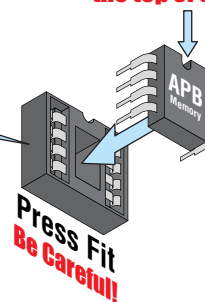

Note: NO APB chip installed on NEW 1830 board, ONLY on older 1830 boards.

1.6 Postal Lock Installation

At some locations, such as gated communities, it will be necessary to **provide access to the mail carrier** so that they can deliver the mail. Mail carrier access will be provided by the installation of an **Arrow Postal Lock**. This is the same lock that the Post Office uses for gang mailboxes. **These locks are not available to the public.** The installer or the building owner/manager will have to call the Post Office and arrange for the installation of this lock into the telephone entry system. All DoorKing commercial telephone entry systems are designed to accept installation of the postal lock.

Prior to installation of the postal lock, be sure power to the telephone entry system is **turned OFF**.

1. Remove the hole plug on the faceplate of the telephone entry system.
2. Cut the wire tie wrapped around the switch **ONLY** when installing postal lock.
3. Remove the two hex nuts from the postal lock-mounting studs. Mount postal lock on the studs and secure with the hex nuts.

When the lock is installed, the pawl of the lock, in the **extended position** is **depressing the switch**. When the mail carrier inserts his key and turns the postal lock, the pawl is **withdrawn into the lock** and the switch will activate the relay for the programmed strike time, that has been programmed for this feature.

Factory default settings for the Postal Lock Switch: After the key has been turned, **Relay 1** will activate (section 3.3.4) for **One (1) second** of strike time (section 3.3.1). The switch input feature (section 3.2.7) is factory set to “activate a relay” and not “dial a phone number”.

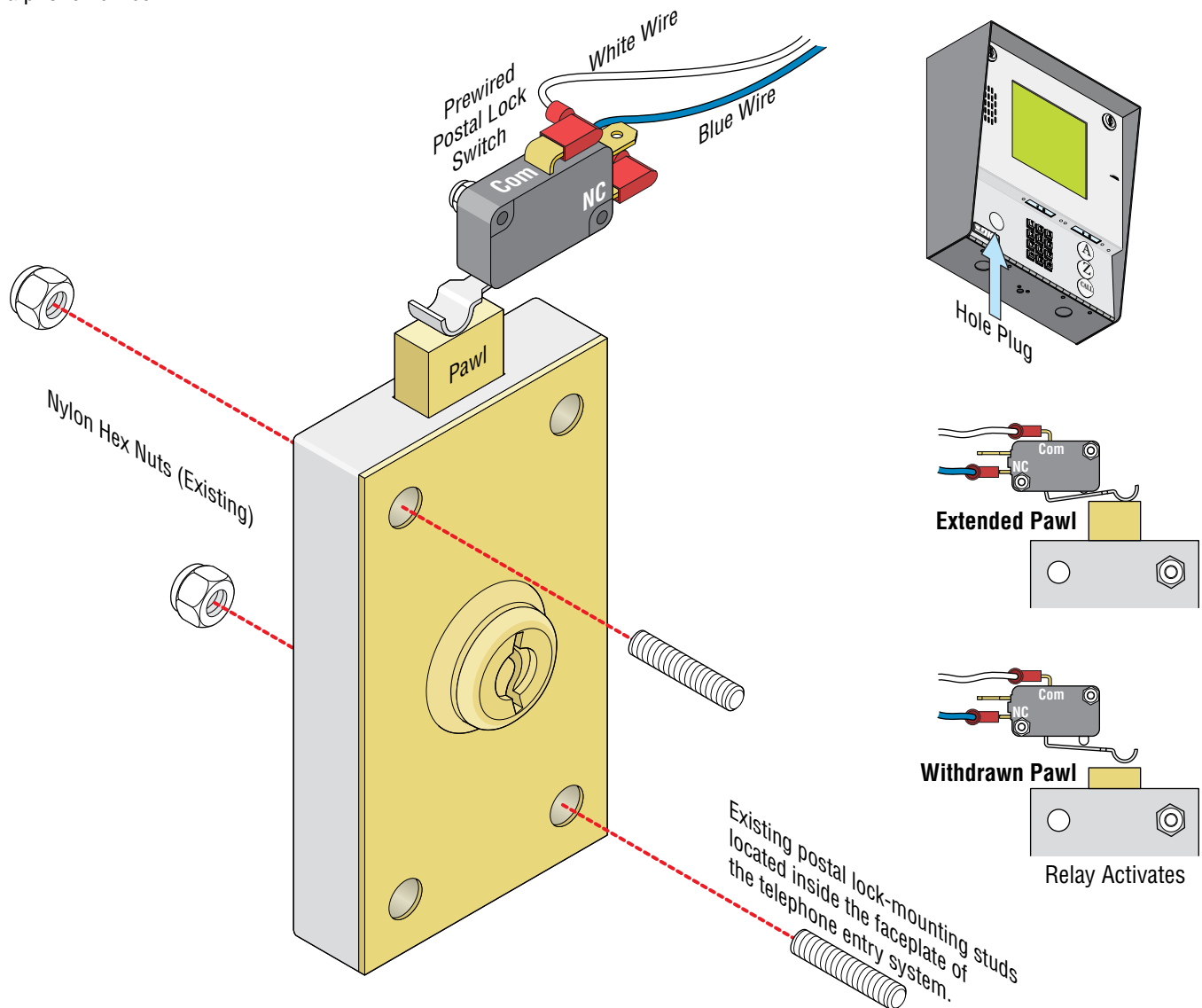

SECTION 2 - WIRING

Prior to installing wiring to the telephone entry system, we suggest that you become familiar with the instructions, illustrations, and wiring guidelines in this manual. This will help insure that you installation is performed in an efficient and professional manner.

The wiring of the telephone entry panel is an extremely important and integral part of the overall access control system. Use proper wire for the communication line, power wires, and be sure that the system is properly grounded. Check all local building ordinances and building codes prior to installing this system. Be sure your installation is in compliance with local codes.

Telcom Access Standards. It is not permissible for customers to use the telcom network lead-in cable to provide the intercom function between the gate and the house. New Zealand Customers: All door and gate entry systems wiring must comply with PTC106: March 2008, Section 9.

WARNING If this telephone entry system is used to control a vehicular gate with an automatic gate operator, the telephone entry system must be mounted a minimum of ten (10) feet away from the gate and gate operator, or in such a way that the user cannot come into contact with the gate or gate operator when using this entry system. If this unit has been installed closer to the automated vehicular gate, do not proceed with any wiring until the unit has been moved and re-installed so that it is in compliance with these instructions.

This telephone entry system contains a number of static sensitive components that can be damaged or destroyed by static discharges during installation or use. **Discharge any static prior to removing the circuit board from the enclosure by touching a proper ground device.**

2.1 Wiring Guidelines

2.1.1 Power

Use only the two (2) supplied transformers (or UL listed equivalent) to power the telephone entry and access control system and any 26, 30 and 31 Bit wiegand input devices that use 16.5 VAC, 20 VA. **DO NOT power any other devices (expansion boards, electric strikes, magnetic locks etc.) from these power transformers.**

Note: Transformers are not supplied on units sold outside the United States. An Inherently Protected Transformer must be used to power this device. Use only transformers that are listed by a recognized testing laboratory to power the telephone entry system.

Two 16.5 VAC, 20 VA for 1833, 1834 and 1835.

One 16.5 VAC, 20 VA and One 16.5 VAC, 40 VA for 1837.

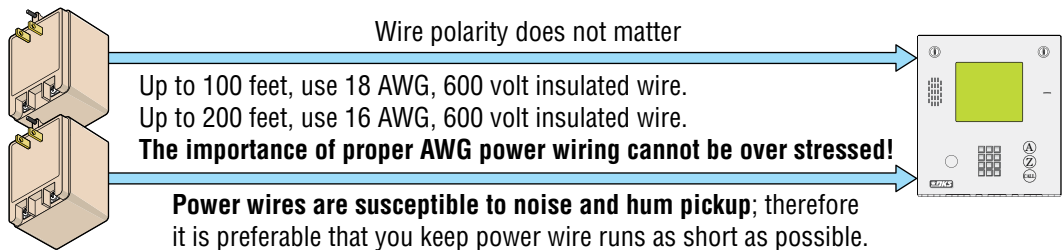

“Optional” 12 volt .8 amp hour gel-cell batteries (DoorKing P/N 1801-008) can be installed to **provide stand-by power in the event of a power outage.** Two batteries are required, one for the system power and one for the auxiliary terminal power.

2.1.2 Wire Runs

Be sure that you use proper wire that has an insulation rated for an underground environment. **All wires should be placed in conduits.** Proper pre-planning can greatly ease the installation and wiring of this system. Always check with the local building code to determine the type of wire required in your municipality.

DO NOT run high voltage (115 V) power lines and low voltage/communication lines in the same conduit. These should be in separate conduits at least six (6) inches apart. Be sure that all phone line wiring is twisted and completely isolated from ground.

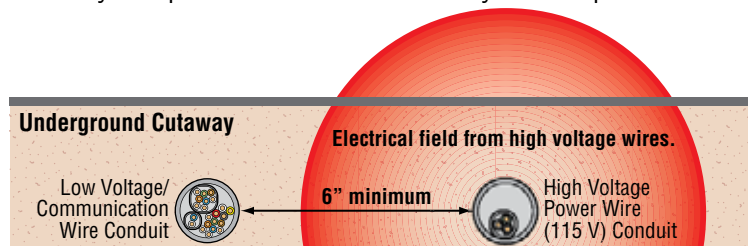

Wiegand wire runs are 500-foot maximum. Use 6-conductor stranded wire with overall shield. 18, 20, 22 or 24 gauge is sufficient for these connections.

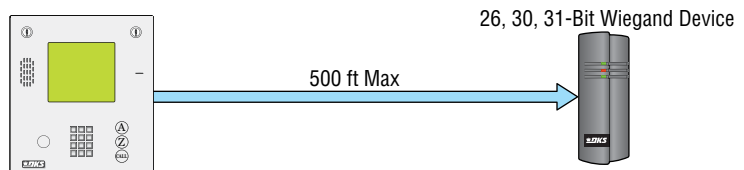

2.1.3 Grounding

Proper grounding of this system is a requirement. To be effective, ground connections should be made with a minimum 12 AWG, 600 volt insulated wire to a ground point within 10 feet of the telephone entry system. The ground point must be at an electrical panel, a metallic cold water pipe that runs in the earth, or a stainless steel grounding rod driven at least ten (10) feet into the soil. **A architectural style mounting post anchored to concrete does NOT make a good ground.**

Some Acceptable Ground Sources

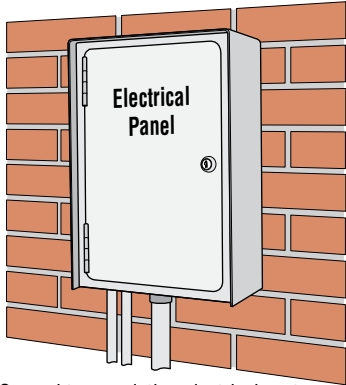

Ground to an existing electrical system.

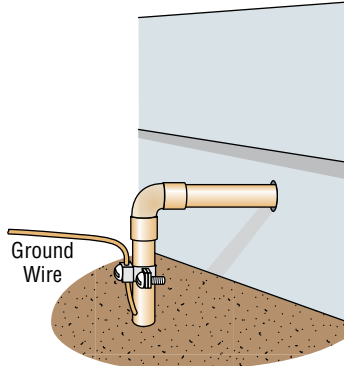

Ground to a metallic cold water pipe.

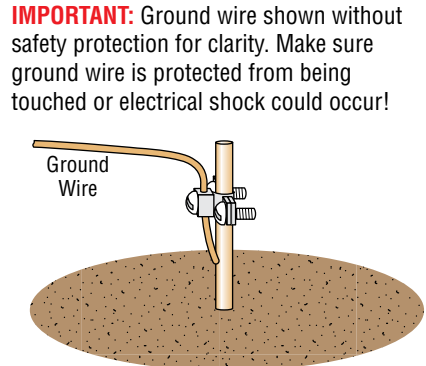

Grounding rod 10 feet in soil.

IMPORTANT: Ground wire shown without safety protection for clarity. Make sure ground wire is protected from being touched or electrical shock could occur!

2.1.4 Surge Suppression

The use of surge suppressors can significantly reduce the chance of component failure because of static charges or surges. DoorKing recommends installing a **Phone Line** surge suppressor (DoorKing P/N 1877-010 or equivalent) and a **Low Voltage** surge suppressor (DoorKing P/N 1878-010 or equivalent) to help protect the entry system from power surges.

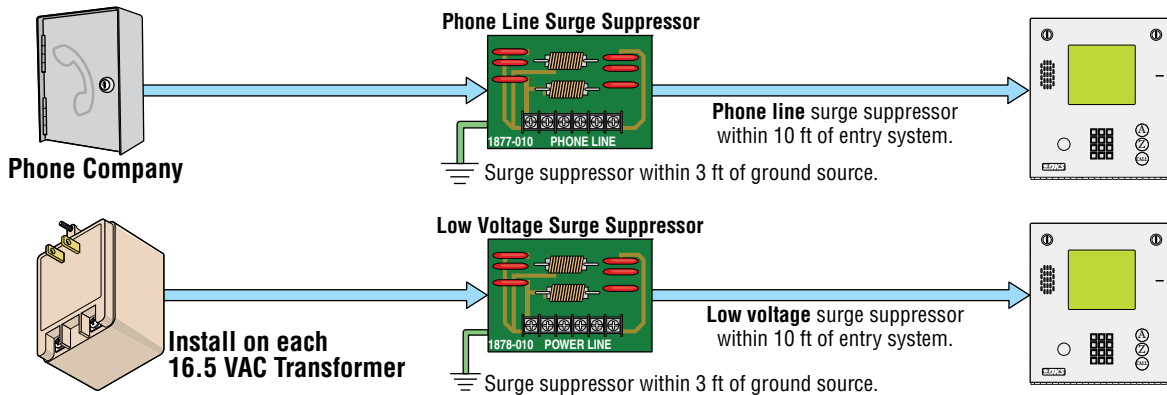

2.1.5 Expansion Boards and Elevator Control

If **Expansion Boards** are being used with this system, refer to the Installation and Wiring manual that came with the Expansion boards, for detailed information on wiring Expansion boards to the PC programmable telephone entry system.

If **Elevator Control** is used with this system, refer to the Elevator Control Installation and Wiring manual for detailed information on wiring the elevator control boards to this system and to the elevator push button control panel.

2.1.6 Ferrite Filter

The Telephone Entry System comes with two (2) **Ferrite Filters**. These will help prevent noise and hum pickup in the phone lines. One is installed around the 16 VAC power wires on the main terminal #19 and #20. The second is installed around all the wires connected to the aux terminal.

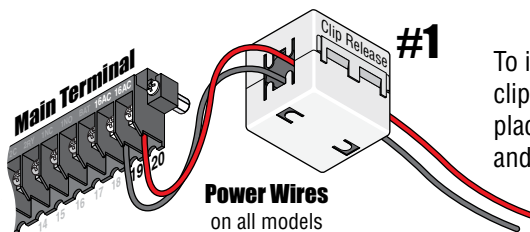

To install the ferrite filter, release the clip on the side to open the filter, place the wires in the circular core and snap the filter closed.

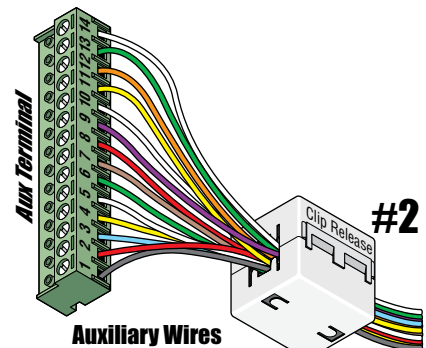

2.2 Terminal Descriptions

See section 4 on page 47 for the locations of the terminals on the circuit board.

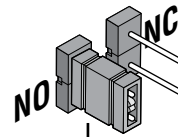

Relay 2 Note: Normally Open and Normally Closed relay jumper is used to set **Relay 2** input on the circuit board (See section 4.6).

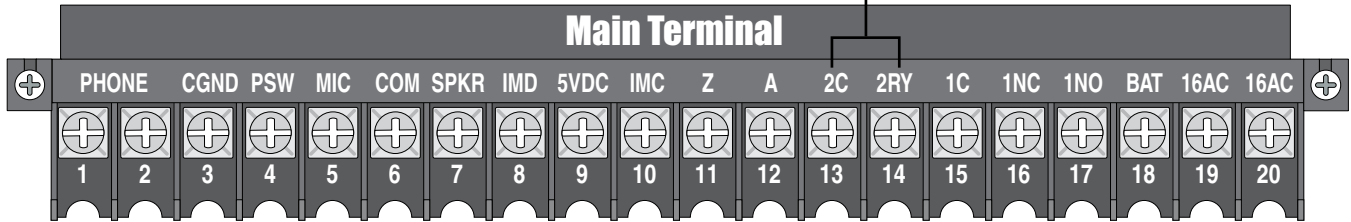

- 1 Phone Line Connection (Wiring **MUST** be twisted and completely isolated from the ground)
- 2 Phone Line Connection (800 ft. max. with 24 AWG wire. 1600 ft. max. with 22 AWG wire.)
- 3 Earth Ground Only (See Section 2.1.3).
- 4 Switch Input. A closure between terminals 4 and 6 will cause the designated relay(s) to activate for the programmed strike time or dial a phone number – see 3.2.7. The Postal Switch is connected here.
- 5 Microphone Input.
- 6 Common for switch input #4, microphone, speaker, AZ & CALL buttons and battery neg.
- 7 Speaker Output.
- 8 (Not used).
- 9 5 VDC Power for LED lighting.
- 10 (Not used).
- 11 “Z” Button Input.
- 12 “A” Button Input.
- 13 Relay 2 Common – 30 Volt, 3 Amp max.
- 14 Relay 2 Contact – 30 Volt, 3 Amp max.
- 15 Relay 1 Common – 30 Volt, 3 Amp max.
- 16 Relay 1 Normally Closed – 30 Volt, 3 Amp max.
- 17 Relay 1 Normally Open – 30 Volt, 3 Amp max.
- 18 Back-up Battery POSITIVE For Phone System Only. (connect negative to terminal 6)
- 19 16 VAC Input Power (200 ft. max. with 16 AWG wire. 20 VA min. for 1833, 1834 and 1835, 40 VA min. for 1837.)
- 20 16 VAC Input Power (100 ft. max. with 18 AWG wire. 200 ft. max. with 16 AWG wire. 20 VA min. for 1833, 1834 and 1835, 40 VA min. for 1837.)

Elevator Control Terminal

Non-Removable

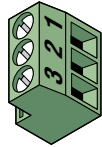

- Note:** Connect to the Elevator Control Board (2348-010). See **Elevator Control Board Manual** 2348-065 for more info.
- 1 DATA 1 – Connect to terminal 20 of elevator control board.
 - 2 DATA 0 – Connect to terminal 21 of elevator control board.
 - 3 COMMON – Connect to terminal 22 of elevator control board.

Aux Terminal

Removable

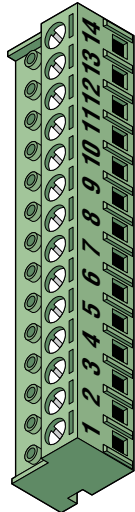

- Note:** The 14-pin aux terminal can be removed for easy wiring. Expansion boards are connected here when used.
- 14 +12 VDC Power.
 - 13 Common.
 - 12 DATA 1.
 - 11 DATA 0.
 - 10 +12 VDC Power.
 - 9 Common.
 - 8 DATA 1.
 - 7 DATA 0.
 - 6 16 VAC Output.
 - 5 16 VAC Output.
 - 4 Back-up Battery NEGATIVE (For Wiegand Only).
 - 3 Back-up Battery POSITIVE (For Wiegand Only).
 - 2 16.5 VAC Input Power – 20 VA.
 - 1 16.5 VAC Input Power – 20 VA. (Powers RS-232, elevator control and Wiegand)
- 26, 30 and 31 Bit Wiegand input (Card Reader) activates **Relay 1** for programmed strike time
- 26, 30 and 31 Bit Wiegand input (Card Reader) activates **Relay 2** for programmed strike time
- For card readers that have additional lighting for outdoor use.

See **Expansion Tracker Board Manual** 2358-065 and section 2.3.2, 2.3.3 for more information.

RS-232 Terminal

Removable

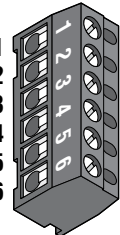

- 1 Transmit Data
- 2 Receive Data
- 3 Request to Send
- 4 Clear to Send
- 5 Signal Ground - Shell
- 6 Not used

Note: Located in the upper left corner of circuit board. The 6-pin terminal can be removed for easy wiring. Connects a PC (See Section 2.4.2).

Relay 0 Terminal

Non-Removable

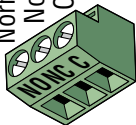

- Normally Open – 30 Volt, 3 Amp max.
- Normally Closed – 30 Volt, 3 Amp max.
- Common – 30 Volt, 3 Amp max.

2.3 Telephone Entry System Wiring

2.3.1 ALL Telephone Entry Systems - NO Tracker Expansion Boards

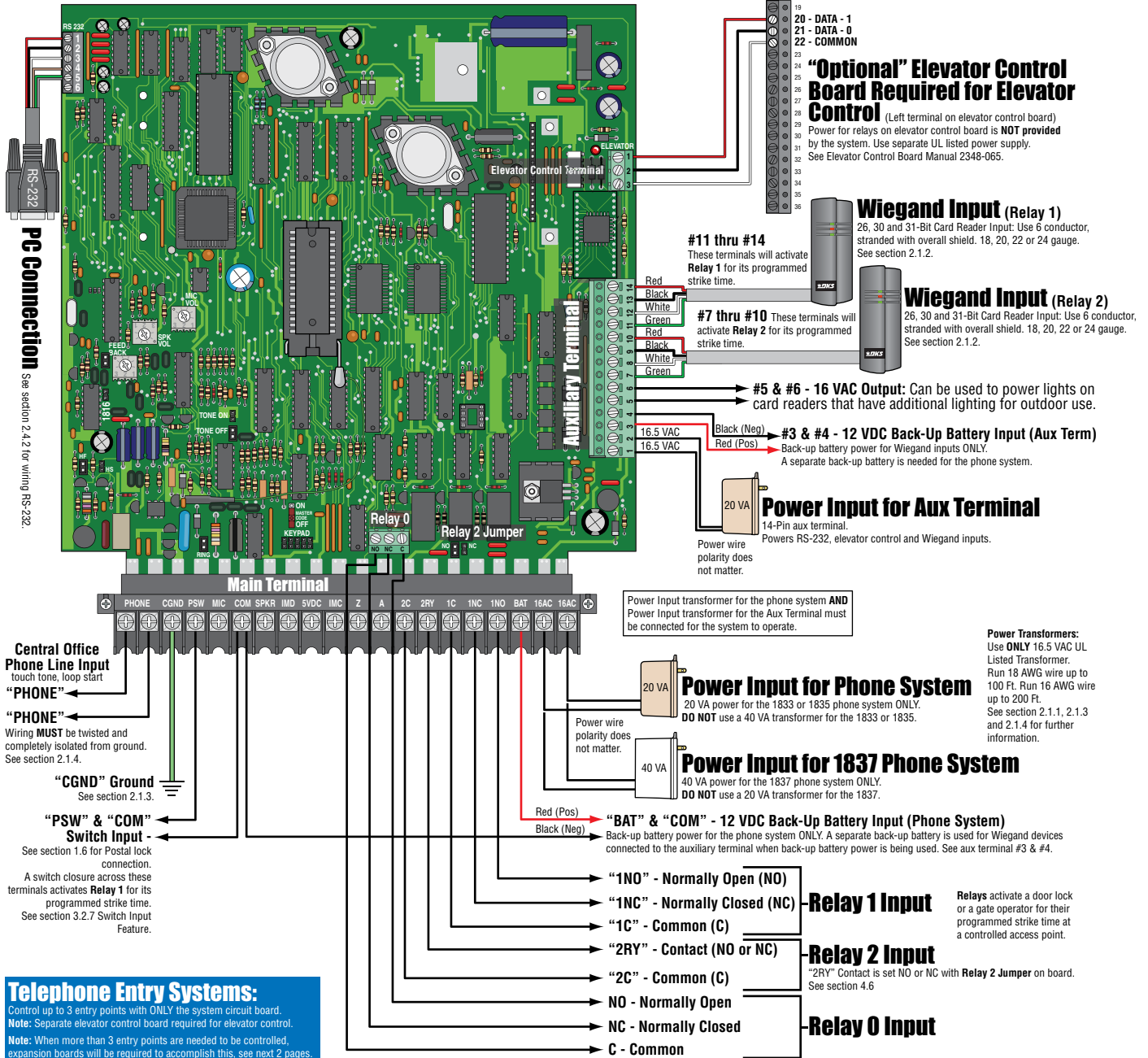

Telephone Entry Systems:
Control up to 3 entry points with **ONLY** the system circuit board.
Note: Separate elevator control board required for elevator control.
Note: When more than 3 entry points are needed to be controlled, expansion boards will be required to accomplish this, see next 2 pages.

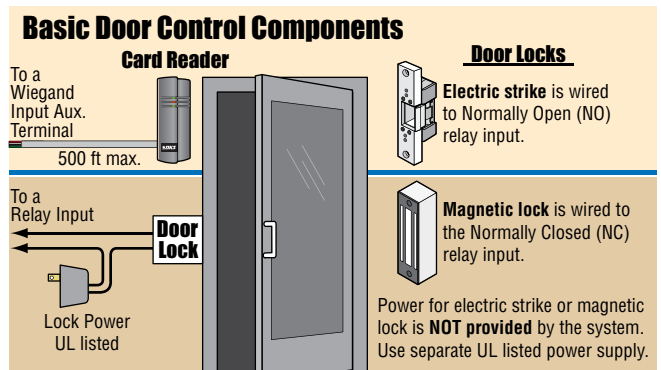
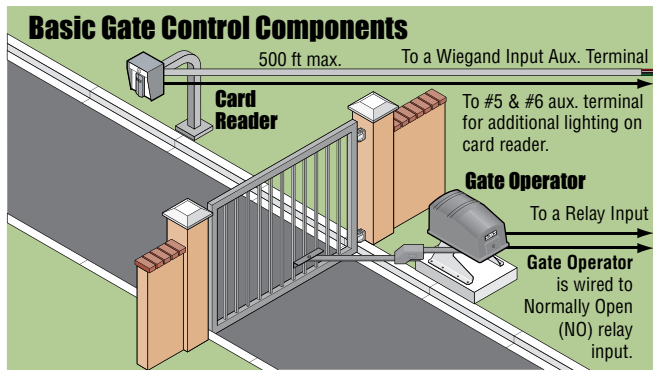

2.3.2 Tracker Expansion Boards (Hardwired)

The model 2358 Tracker Expansion Board (sold separately) allows you to expand the number of remote entry points that the telephone entry system can control. One tracker expansion board is required for **EACH** remote entry point. Up to 24 boards can be hardwired to the circuit board's **Aux Terminal** (First 12 boards connected to #7 - #9 and 12 more boards connected to #11 - #13 if needed). Tracker expansion boards must have their own power source and the farthest board can be no more than 2000 ft from the telephone entry system. Each board must have a board address set on it to identify it to the telephone entry system and if wiring more than 8 boards, some zone addresses need to be used for identification. The tracker expansion boards are pre-programmed with many features but can be re-programmed for specific needs when desired. See **Tracker Expansion Board Manual 2358-065** for **ALL** wiring and programming options.

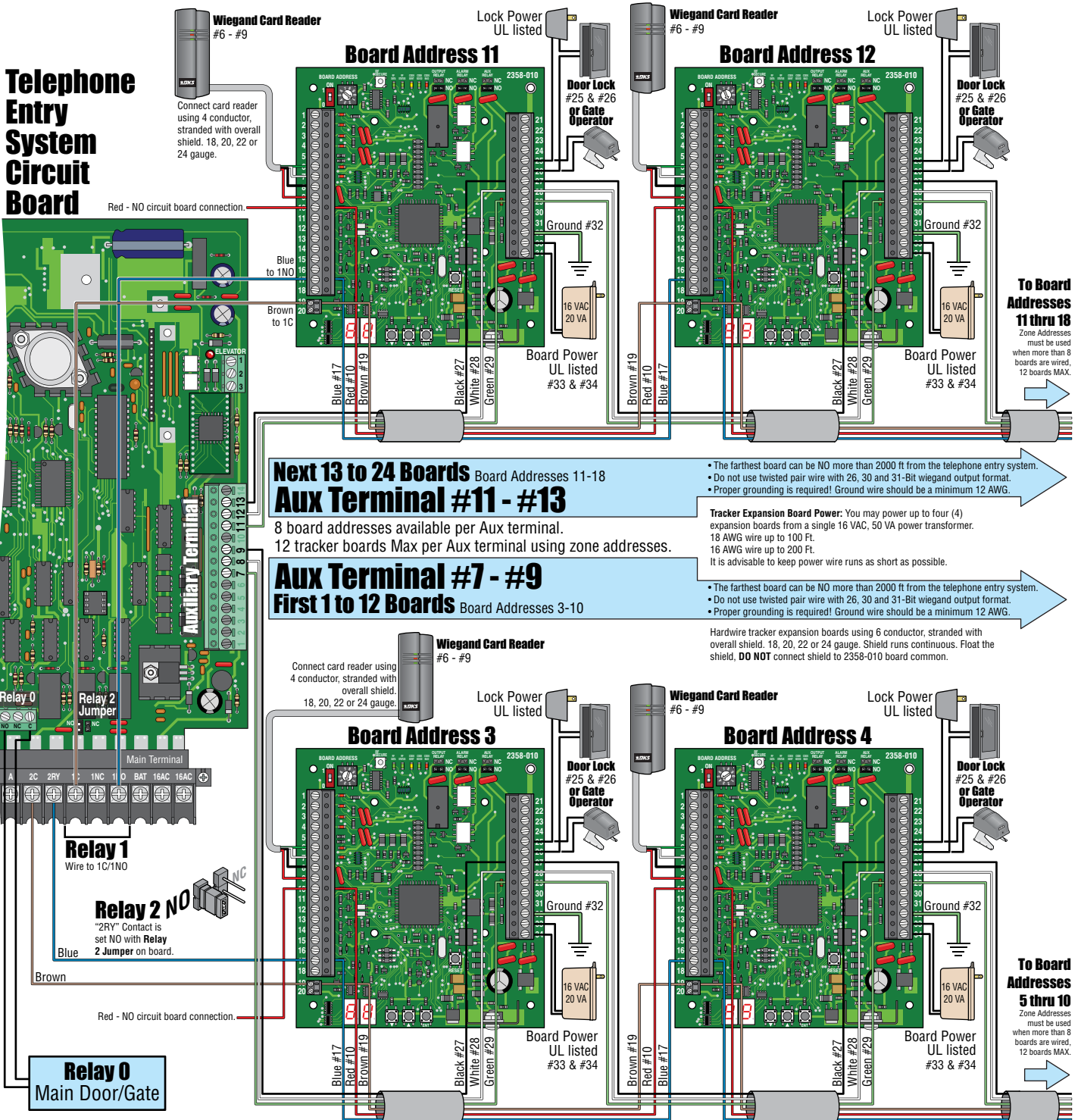

2.3.3 Tracker Expansion Boards using Wireless Communication

The model 2358 Tracker Expansion Board (sold separately) allows you to expand the number of remote entry points that the telephone entry system can control. One tracker expansion board is required for **EACH** remote entry point. Communicate wirelessly between the tracker expansion boards and the 1830 Series controller without having to run wiring from each remote access point to the 1830 Series controller. The model 1489 wireless tracker expansion board kit and the model 2361 wireless baseboard kit (each sold separately) plugged onto to circuit boards for wireless communication. Wireless tracker expansion boards can be up to 100 ft from the telephone entry system (approximate). This distance can be extended by using longer range antennas (sold separately) and/or a 2372 wireless dual band repeater (sold separately). Each tracker expansion board must have a board address set on it to identify it to the telephone entry system. **Board addresses 3-10 will activate RELAY 2 and 11-18 will activate RELAY 1** on the telephone entry system. Board addresses can be set the same for multiple boards (zone addresses) when **MORE** than 8 boards need to activate a specific RELAY (12 boards MAX for each relay). The tracker expansion boards are pre-programmed with many features but can be programmed for specific needs when desired (See **Tracker Expansion Board Manual 2358-065** for **ALL** programming options). See DoorKing's web site and the instruction sheets with the wireless kits for complete installation information when using wireless communication.

Telephone Entry System Circuit Board

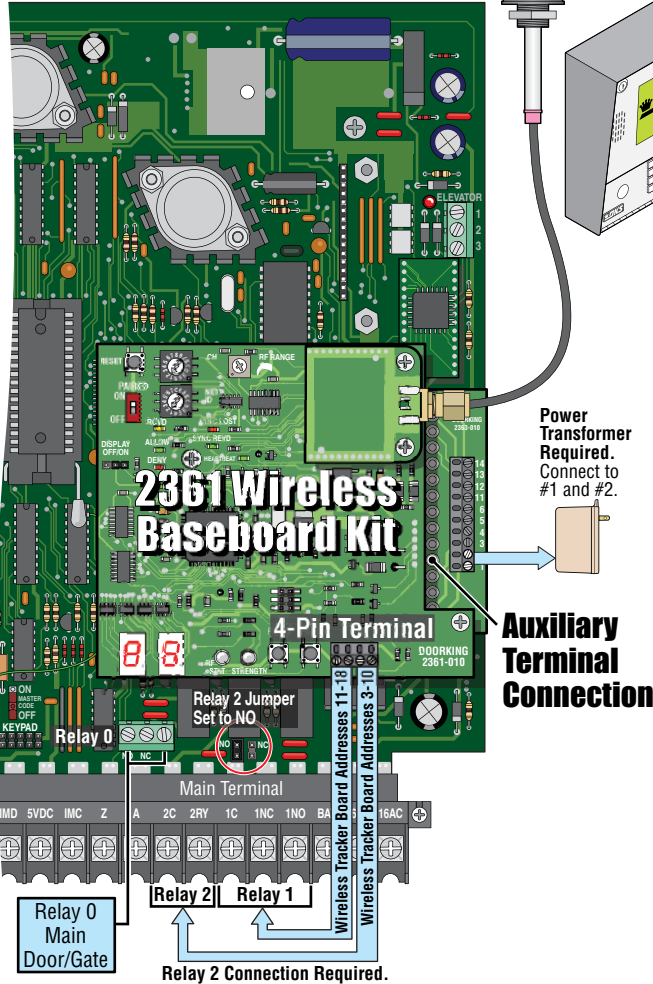

Antenna Note: This wireless system works best when the antennas are in direct-line-of-sight with each other, in free air as high as possible above the ground.

Signal Note: Channel Number and RF ID Number must match on 2361 wireless baseboard kit and ALL 1489 wireless kits.

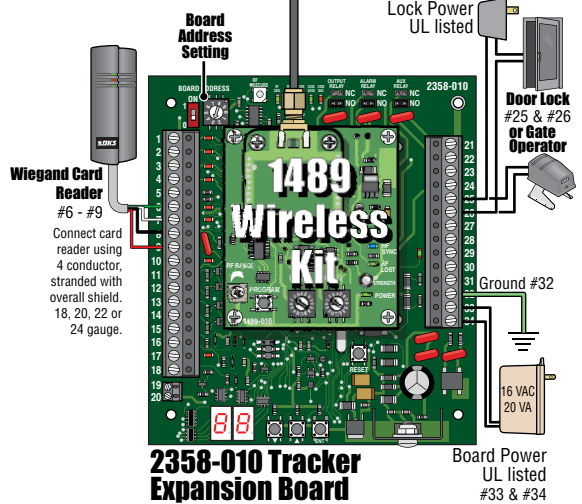

At a Remote Entry Point

Antenna Options

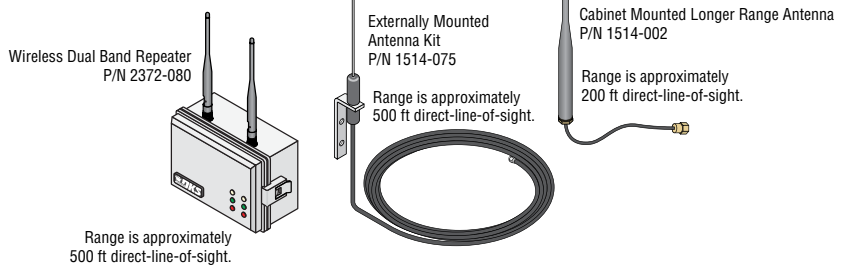

2.4 PC Connection Options

Connecting the telephone entry system to a PC may be accomplished by **SEVEN (7) different methods** in this section.

2.4.1 Phone Modem Connection

Use your **EXISTING** modem to connect your PC to the entry system. Phone modem can **ONLY** connect to one entry system at a time.

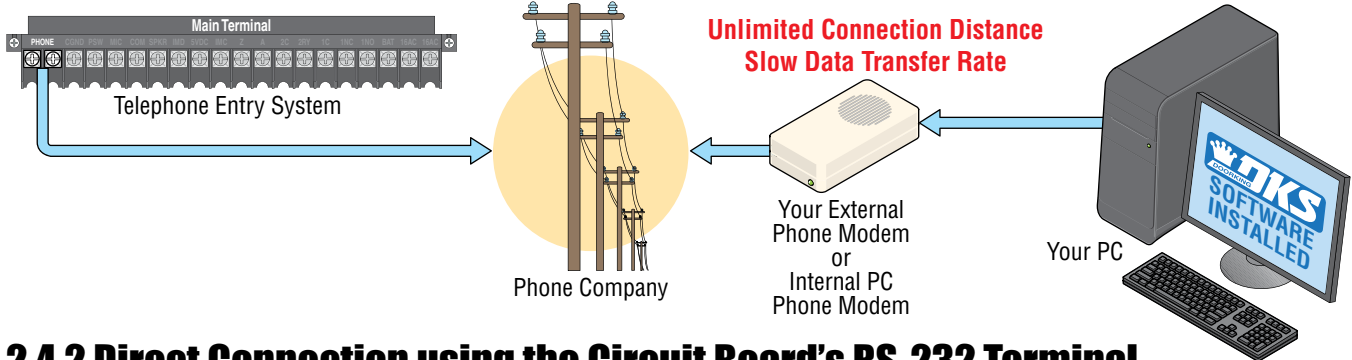

2.4.2 Direct Connection using the Circuit Board's RS-232 Terminal

Requires DoorKing RS-232 9-pin cable P/N 1818-040 and RS-232 to USB Adapter P/N 1815-037 to connect to PC. Sending data to **MULTIPLE** entry systems in one programming step with RS-232 is limited to the number of RS-232 Ports installed.

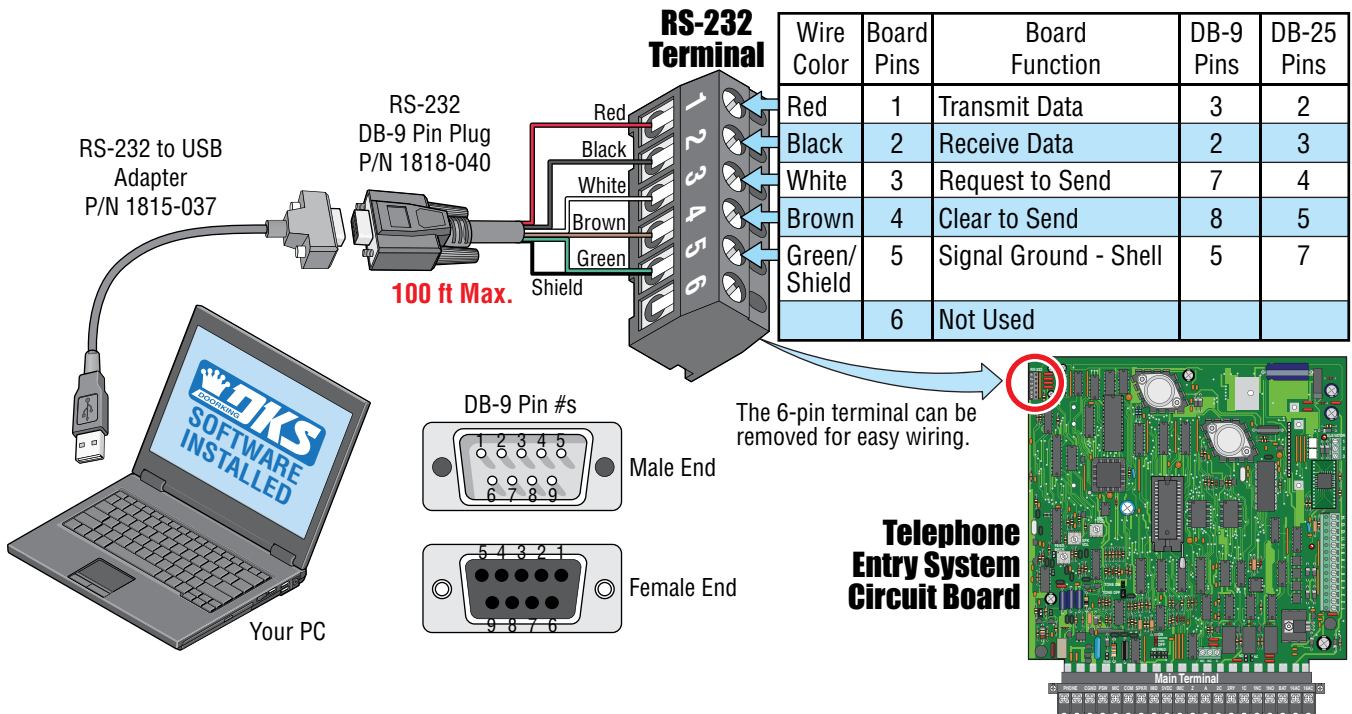

2.4.3 RS-232 Terminal using RS-422/USB Connection

Requires RS-422 adapter kit (DoorKing P/N 1508-055). Sending data to **MULTIPLE** entry systems in one programming step with RS-422 is limited to the number of USB Ports installed.

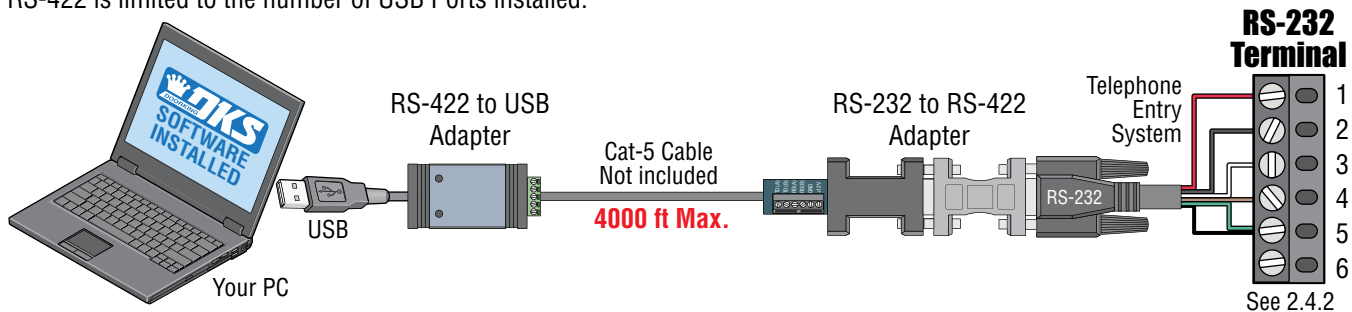

2.4.4 RS-232 Terminal using Wireless Adapter Connection

Requires DoorKing Wireless Adapter Kit (Different kits available). Managing to up to three entry systems with your PC.

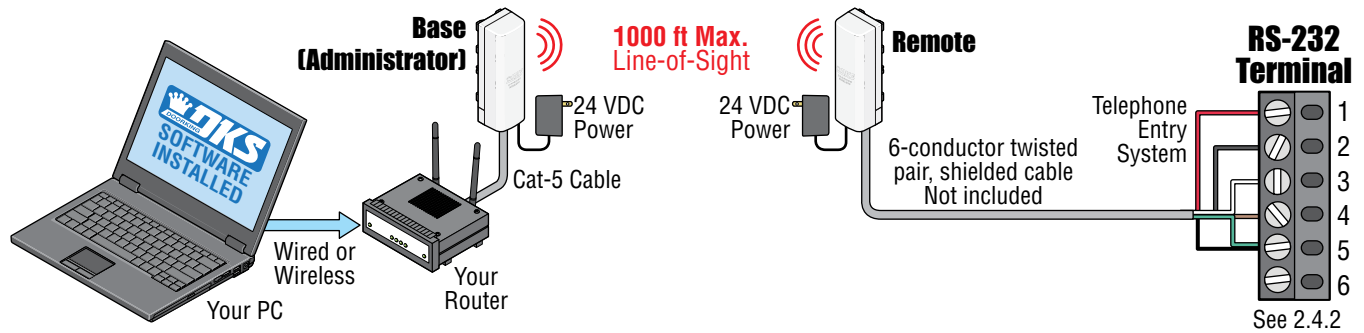

2.4.5 RS-232 Terminal using TCP/IP Converter LAN Connection (Local Area Network)

Requires TCP/IP Converter Kit (DoorKing P/N 1830-185). Sending data to MULTIPLE entry systems in one programming step with TCP/IP is limited to the number of ports on your router.

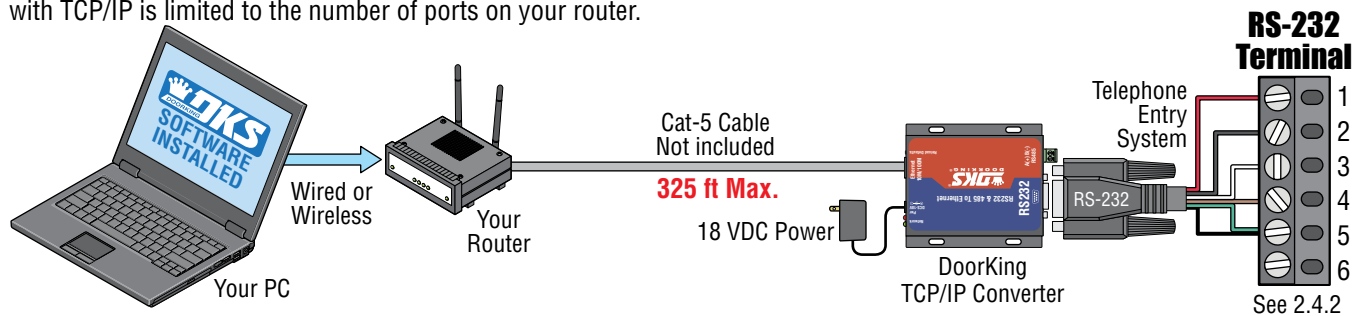

2.4.6 RS-232 Terminal using TCP/IP Converter WAN Connection (Wide Area Network)

Requires a TCP/IP Converter Kit (P/N 1830-185 Third party or DKS IM server P/N 1830-186). Can send data to MULTIPLE entry systems in one programming step.

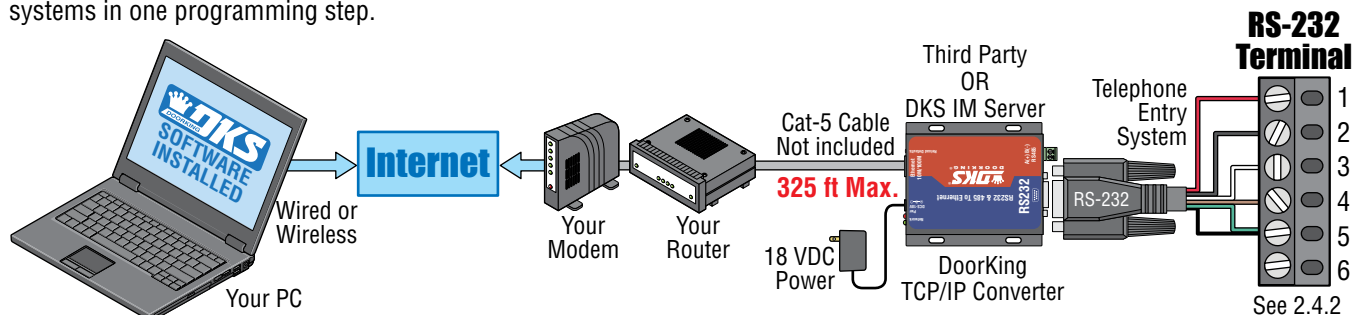

2.4.7 DoorKing DKS Internet-Modem Server

NO additional hardware required. You can send data to MULTIPLE entry systems in one programming step.

Multiple Entry Systems

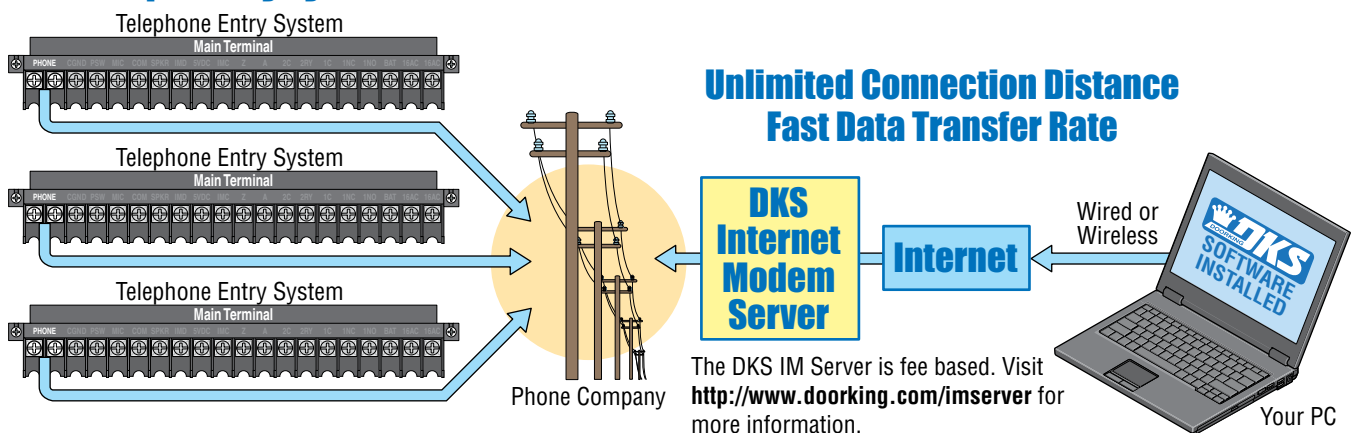

SECTION 3 - PROGRAMMING

We strongly suggest that you read these programming instructions in their entirety before beginning any programming of this telephone entry system.

IMPORTANT! Many of the advanced features available with this telephone entry system **CANNOT** be programmed from the system keypad. These advanced features include relay hold open time zones, security levels, elevator control options and programming via the internet using DKS servers. If any of these advanced features are used, the system **MUST** be programmed with a PC using the **DoorKing Remote Account Manager for Windows** software, VERSION 6.3.g or higher. Refer to the software help screen for more information on these advanced features.

3.1 General Programming Information

The DoorKing PC Programmable Telephone Entry System is primarily programmed by using the DoorKing Remote Account Manager for Windows software. However, the system can also be partially programmed from the keypad on the front of the entry system.

Programming the entry system can also be preformed off-site using a user supplied PC with the DKS software loaded on it. Make sure the **RING** pin jumper is in place on the circuit board, which was factory installed. See section 4.5 for more information.

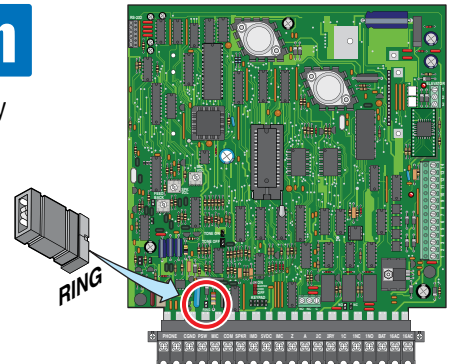

The PC programmable telephone entry systems have three relays on the circuit board, all of which are programmable for any function required. These relays are designated as Relay 0 (R 0), Relay 1 (R 1), and Relay 2 (R 2). If Expansion boards are used with this system, it is very important that you understand the function of these three relays. The wiegand input auxiliary terminals (also the Expansion board input terminals) can only cause R 1 or R 2 to activate. Wiegand input devices **CANNOT** cause R 0 to activate. Therefore, if Tracker Expansion boards are used with this system, **R 0 MUST be designated as the PRIMARY relay**, and R 1 and R 2 are then designated as Tracker Expansion board command (CMD) relays with R 2 controlling Expansion boards 1 through 8 (system relays 3-10), and R 1 controlling Expansion boards 9 through 16 (system relays 11-18). The **PRIMARY** relay is the relay that a resident activates from their telephone after receiving a call from a visitor. When Tracker Expansion boards or other wiegand devices are used with the system, be sure that R 0 is programmed to respond to the tone open number (typically 9), the postal switch input, and the rotary dial 9 function.

3.1.1 Programming from a PC

Prior to programming the system with a PC and the DoorKing Remote Account Manager for Windows Software, there is certain information that you must know and must program into the system before the computer can communicate with the system. See next page section 3.2 to set-up the telephone entry system for PC programming. Programming the system with a PC may be accomplished by **1) Phone modem, 2) RS-232 direct connection, 3) RS-422 direct connection, 4) Wireless Connection, 5) TCP/IP LAN direct connection, 6) TCP/IP WAN or Internet, 7) DK Internet-Modem Server**. See section 2.4 PC Connection Options for all layouts and additional hardware that is needed for each. All options require the DoorKing Remote Account Manager for Windows Software VERSION 6.3.g or higher.

3.1.2 Programming from the Telephone Entry System Keypad

Follow the programming instructions as described in each section of this manual. The system will prompt you with short tones (**beep**) when programming steps have been followed correctly, and with a long tone (**beeeeeep**) when the programming step is ended. The LCD display will also assist you in viewing the information that you are programming (NOT AVAILABLE with the 1833 system). It is highly recommended that you complete the resident information in section 7 in back of this manual prior to programming from the system keypad. This will provide you with the information needed to complete the manual programming sequence (section 3.2). When programming from the system keypad, after each programming step is performed correctly, a short tone (**beep**) will be heard. When the programming session is ended, a long tone (**beeeeeep**) will be heard.

Important Note: Relay hold open time zones, security levels, holiday schedules, anti-pass back IN / OUT tables, anti-pass back re-sync schedules and elevator control features **CANNOT** be programmed from the system keypad. **These advanced features can only be programmed from a PC using the DoorKing Remote Account Manager Software.**

3.1.3 System Memory Chip Identification

All DKS 1830 series telephone entry systems come standard with a **3000 memory chip installed on the board**. The smaller APB/memory chip no longer exists on the NEW 1830 board. The NEW 1830 can be re-programmed to work with with OLDER existing 1830 entry systems.

The information below will assist you identifying chip specifications for older 1830 entry systems.

Before programming a NEW 1830 entry system to operate with existing older 1830 systems, you must know the memory capacity and type of the EEPROM chips that have been installed in the older units. This can be determined by inspecting the small chip that has a tag listing the memory size on it and labeled APB if anti-pass back is enabled. The memory size determines the number of residents, vendors, four-digit entry codes and device codes that can be stored in the system. APB indicates that the chip set has anti-pass back capability. The table shows the valid part numbers available with each memory level.

If you need to remove and replace chips, see Section 1.5 Memory Chip Replacement.

If you are going to re-program a NEW 1830 (less than 3000) to be used with existing OLDER 1830(s), Section 3.2.11 will need to be completed to MATCH the OLDER existing 1830(s).

Chip Part Number		System Memory	Phone Number Capacity	Name Capacity	Entry Code Capacity	Device Code Capacity
Standard	APB					
1835-150	1835-140	25	25	25	25	625
1835-151	1835-141	75	75	75	75	1875
1835-152	1835-142	125	125	125	125	3125
1835-153	1835-143	250	250	250	250	6250
1835-154	1835-144	500	500	500	500	8000
1835-155	1835-145	1000	1000	1000	1000	8000
1835-156	1835-146	2000	2000	2000	2000	8000
1835-157	1835-147	3000	3000	3000	3000	8000

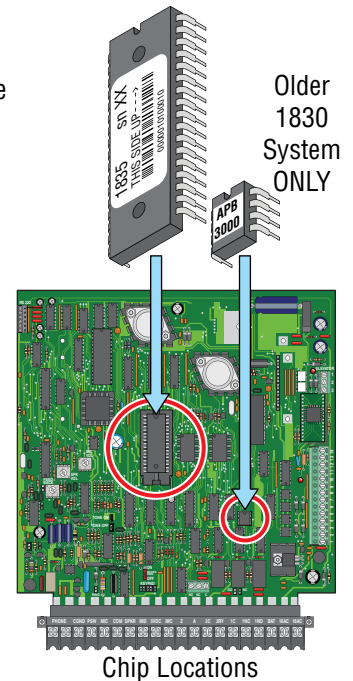

3.2 Set-up Telephone Entry System for PC Programming

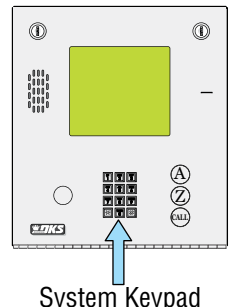

Prior to using a PC to program this PC Programmable Telephone Entry System with the DoorKing Remote Account Manager for Windows software, the programming steps in section 3.2.1 through 3.2.11 factory settings **MUST** be reviewed or re-programmed if necessary (most factory settings are typically desired). There is no need to re-program these settings unless you want to change them. For easy reference, refer to the chart on page 30 that list the various programming functions and their factory default settings.

Section 3.2 can ONLY be programmed from the System Keypad. There is NO programming sequence in the Remote Account Manager Software to program these features with.

Important Note: If you make a mistake while programming, press keys at the same time to escape from programming no matter how much has been completed, then begin again at step 1.

3.2.1 Master Code

This programming step sets the system **MASTER CODE**. The master code is the four-digit number **REQUIRED** to gain access to the system memory. **You need to know the master code prior to programming the system with the PC, or to perform ANY of the programming functions on the following pages. It MUST be programmed in from the system keypad.**

NO Factory setting - Each entry system's master code **MUST** be unique. See section 4.4 for more information about the master code switch.

1. Open the cabinet of the telephone entry system and turn the master code switch **ON**.
2. Enter a four-digit master code then press (beep).
3. Turn the master code switch **OFF** and close the cabinet.

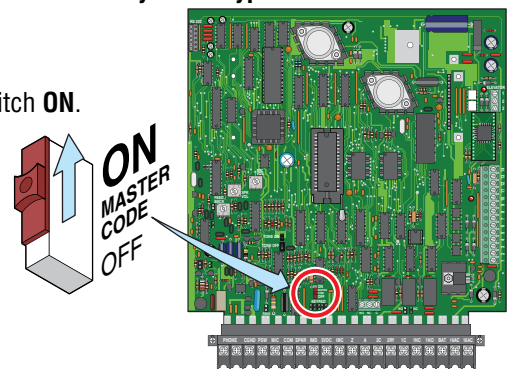

Important Note: There is no way of retrieving the master code after it has been programmed in. If you forget it, you will have to program in a new one but all other previously programmed information will remain intact.

3.2.2 Number of Area Codes Allowed

This programming step sets the system to allow either “up to 10” or “up to 255” alternate area codes (AAC) to be programmed into the system.

Factory setting = 1 (255 area codes)

1. Press and enter your four-digit MASTER CODE (beep).

The LCD display on the 1834, 1835 and 1837 systems will read: 10 AAC=0 255 AAC=1

2. Enter (beep) for **10 area codes** OR enter (beep) for **255 area codes**.

The display will read: ERASE MEM? 1=Y 0=N. (Choosing 1 **WILL ERASE** the memory and **WILL** evoke the area code choice. Choosing 0 **WILL NOT ERASE** memory and **WILL NOT** evoke the choice).

3. Enter either (beeeeeep) to **set the change** OR (beeeeeep) to **cancel the change**.

CAUTION: When changing an existing 1830 system from 255 to 10, **ALL existing programmed memory will be erased** but the programmed screen display messages, Section 3.4.

3.2.3 Call-up Operation when Interfacing with DoorKing 1816 or 1820 Systems

This feature is **ONLY** used when the telephone entry system is interfaced with a DoorKing 1816 or 1820 Telephone Intercom system under certain **special applications**. This **CALL-UP feature** provides special programming that will allow the system to call the phone number of a CO (Central Office) line connected to these systems. Once the 1816 or 1820 answers the call, the system will automatically send out DTMF tones that will activate the **CALL-UP feature** in the 1816 or 1820 system, and then send the four digit directory code to the resident selected by the visitor. This allows visitors to contact tenants in the building that do not have CO phone service through the telephone entry system. Refer to the 1816 / 1820 Installation Manual, and check with your DoorKing representative on the special applications that this feature is used for.

Factory setting = OFF (DO NOT turn ON unless interfacing with a 1816 or 1820)

1. Press and enter your four-digit MASTER CODE (beep).

2. Enter (beep) to turn the call-up feature **OFF**.

Enter (beep) to turn the call-up feature **ON**. **Special applications ONLY**.

3. Press together to end this programming sequence (beeeeeep).

3.2.4 Resident Elevator Button Relay Time

When elevator control is in use, an access device such as a card reader must be installed in the elevator car to allow residents access to the floors in the building. The time interval that the button(s) is “live” after the resident activates the access device is dependant on the revision level of the 1830 series circuit board, not the 2348 elevator control board. **The relay time interval for 1830 series circuit boards with revision level A-E is set at 7 seconds. The time interval can be programmed from 1 – 254 seconds on boards with revision level F and higher.**

Factory setting = 007 (7 seconds)

1. Press and enter your four-digit MASTER CODE (beep).

The LCD display on the 1835 and 1837 systems will read: RES ELE TIME xxx SEC

2. Enter the **relay time** in seconds using **three-digits** (001 – 254), then press (beep).

3. Press together to end this programming step (beeeeeep).

3.2.5 “Tone Open” Sound On or Off

The following programming sequence turns the “Tone Open” sound either On or Off (when the relays activate). This feature is available on Rev K boards or higher. See 3.3.3 for information about “Tone Open” numbers feature.

Factory setting = 1 (tone ON)

1. Press and enter your four-digit MASTER CODE (beep).

The LCD display on the 1835 and 1837 systems will read: BEEP RLY OP? 0=N 1=Y

2. Enter for **YES - tone will sound** or for **NO - tone will not sound**, then press (beep).

3. Press together to end this programming sequence (beeeeeep).

3.2.6 RS-232 Speed Setting

The following programming sequence sets an optional slower RS-232 speed. This feature is available on Rev M boards or higher and the Remote Account Manager Software, Version 6.3.g, must be used.

Factory setting = 1 (19200 baud rate)

1. Press and enter your four-digit MASTER CODE (beep).
2. Enter for **9600 baud rate** or for **19200 baud rate**, then press (beep).
3. Press together to end this programming sequence (**beeeeeep**).

3.2.7 Switch Input Feature

The following programming sequence sets the switch input (main terminals #4 and #6) to either activate a relay(s) or call the phone number programmed in directory code 0, 00, 000 or 0000. Refer to section 3.3.4 to determine which relay(s) will activate when the switch input is activated. This feature is available on Rev K boards or higher.

Factory setting = 0 (switch input activates relay)

1. Press and enter your four-digit MASTER CODE (beep).
The LCD display on the 1835 and 1837 systems will read: KEY IN DIAL? 0=N 1=Y
2. Enter for **YES** (the switch input will dial a phone number) or for **NO** (the switch input will activate the relay), then press (beep).
3. Press together to end this programming sequence (**beeeeeep**).

3.2.8 Elevator Control Feature

This new elevator feature authorizes floor access to the Floor Level identified in the Resident Screen in the software program **AND** to the floor(s) level identified in the Security Level screen. If this feature is turned off, access will be granted only the floor identified in the user's security level. This feature is available on Rev K boards or higher.

Factory setting = 1 (new elevator function is turned ON)

1. Press and enter your four-digit MASTER CODE (beep).
The LCD display on the 1835 and 1837 systems will read: NEW EL FUNC? 0=N 1=Y
2. Enter for **YES** (access is authorized to both the floor identified in the resident screen and to the floor(s) identified in the user's security level) OR for **NO** (access is authorized only to the floor(s) identified in the security level screen), then press (beep).
3. Press together to end this programming sequence (**beeeeeep**).

3.2.9 Single or Multiple Systems

This program sequence sets the telephone entry system to operate as a single unit on the phone line, or to share the phone line with other units. If multiple systems are sharing the same phone line, then each one must be set as a "multiple system" and each must have a unique master code.

Factory setting = Single System.

1. Press and enter your four-digit MASTER CODE (beep).
2. Press (beep) for a **single system**, OR (beep) for **multiple systems**.
3. Press together to end this programming sequence (**beeeeeep**).

3.2.10 IM Server Client System Phone Number or System ID Number

The following programming sequence is necessary **ONLY** when using **DoorKing IM Server Client Mode**. After installing the Remote Account Manager Software, Version 6.3.g, there is an option to use the DoorKing IM Server Client service type on the System Information screen. **When registering an entry system online with the IM Server, client mode requires either the 10-digit phone number of the entry system or 10 digit ID number which the server will assign.** This phone number or ID number **MUST** be programmed into the entry system to use the IM Server Client mode.

Visit <http://www.doorking.com/imserver> for more information.

Factory setting = No number in system

1. Press and enter your four-digit MASTER CODE (beep).
2. Enter the **10-digit phone number** or **system ID number**, then press (beep).
3. Press TOGETHER to end this programming sequence (**beeeeeep**).

Notes: This programming sequence automatically turns Client mode ON (section 6.1.9).

To view programmed number in system see section 6.1.7. To check for problems see section 6.1.8.

3.2.11 Re-Program Memory Size, with/without Cards and Anti-Pass Back

These features **ONLY** need to be **re-programmed** when a **NEW 1830** entry system is to be used with **EXISTING OLDER 1830** entry systems that have a **smaller memory size (less than 3000) with or without cards and anti-pass back capability** and all units are being managed by DKS Remote Account Manager Software with the “Share Info” feature. **The new 1830 chip specification MUST MATCH** the older 1830 chip specifications or **EXISTING** programming conflicts will occur. See section 3.1.3 for more information about 1830 memory specifications.

Factory setting = Step 2 - 8 (3000), Step 4 - 2 (Using Cards WITH Anti-Pass Back)

1. Press and enter your four-digit MASTER CODE (beep).

The LCD display will read: MEM SIZE? 1 THRU 8

2. Enter a **single-digit** for memory size (1-8), then press (beep).

1=25 2=75 3=125 4=250 5=500 6=1000 7=2000 8=3000

The LCD display will read: xxxx MEM OK? 0=N 1=Y (xxxx is the memory you have chosen).

3. Press **YES** (beep), OR **NO** (beep).

Note: Selecting NO (0*) will go back to the previous step.

After **YES** (1*) is entered, The LCD display will read: CARDS 0=N 1=Y 2=ANTI

4. Press (beep) **NO Cards**, OR (beep) **Use Cards**, OR (beep) **Use Cards with Anti-Pass Back**

The LCD display will read: ERASE MEM? 1=Y 0=N

5. Press **YES** (beep), OR **NO** (beep).

Note: Selecting NO (0*) will go back to the first step.

After **YES** (1* BEEP) is entered, A long beep will be heard after memory has been erased (**beeeeeep**).

CAUTION: This programming sequence will **erase ALL** information stored on the existing memory chip.

STOP!! If the telephone entry system is to be programmed from a PC, **NO** other programming is required at the system itself. Refer to the Remote Account Manager for Windows Software help screens for additional programming information. Continue with the remaining sections in this chapter if the telephone entry system will be programmed by any other method. If the factory setting matches your need, there is no reason to reprogram that section.

Remember that advanced features like relay hold open time zones, security levels, and elevator control functions can **ONLY** be programmed from the Remote Account Manager Software. If any of these advanced features are being used, **DO NOT** proceed with any other programming steps in this manual.

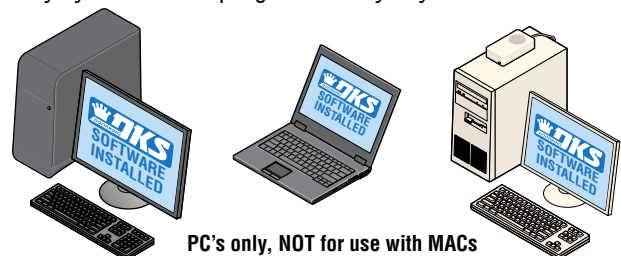

Download **Remote Account Manager** software at:

<http://www.doorking.com/telephone/telephone-accessories/software-remote-account-manager>



Overview for Entry System Keypad Programming

		Page #	Section	Command	Factory Setting
NOT Programmable from Software. Program from System Keypad ONLY.	Section 3.2 Setup Entry System for PC Programming				
	Master Code	26	3.2.1	Master Switch ON	No factory setting
	Number of Area Codes Allowed	27	3.2.2	* 60	1 (255 area codes)
	Call-Up Operation, Interfacing with DKS 1816 or 1820 Systems Only	27	3.2.3	* 78	0 (OFF)
	Resident Elevator Button Relay Time	27	3.2.4	* 36	007 (7 sec)
	Open Tone ON or OFF	27	3.2.5	* 15	1 (tone ON)
	RS-232 Speed Setting	28	3.2.6	* 85	1 (19200 Baud)
	Switch Input Feature	28	3.2.7	* 18	0 (activates relay)
	Elevator Control Feature	28	3.2.8	* 75	1 (Turned ON)
	Single or Multiple Systems	28	3.2.9	* 04	Single system
	IM Server Client System Phone Number or System ID Number	29	3.2.10	* 59	Issued by DoorKing
	Re-Program Memory Size, with/without Cards and Anti-Pass Back (Only needed when New 1830 system is used with OLDER 1830 systems)	29	3.2.11	* 95	8-3000 Memory 2-Card w/Anti-Pass Back
	Testing IM Server	Display IM Server Client Phone Number or System ID Number	58	6.1.7	* 56
Test Connection to IM Server Client		58	6.1.8	* 29	Testing Option
Turn IM Server Client Mode OFF or ON (Automatically ON after programming 3.2.10)		58	6.1.9	* 55	Testing Option OFF
Section 3.3 General Programming using System Keypad					
	Relay Strike Time	31	3.3.1	* 03	Relay 0: 01 (1 sec) Relay 1: 01 (1 sec) Relay 2: 01 (1 sec)
	Talk Time	31	3.3.2	* 08	060 (60 sec)
	Tone Open Numbers	32	3.3.3	* 05	Relay 0: # # # # Relay 1: 9 8 7 6 Relay 2: 5 4 3 2
	Switch Input Relay(s) Activation	32	3.3.4	* 50	010 (relay 1 activates)
	Touch-tone / Rotary-dial	33	3.3.5	* 07	Touch-tone
	Rotary Dial-9 Relay(s) Activation	33	3.3.6	* 51	010 (relay 1 activates)
Section 3.4 Programming Letters, Numbers and Messages					
	Programming Letters and Numbers from Keypad	34	3.4.1	None	No factory setting
	Programming the User Message - 1835 System	35	3.4.2	* 80	Factory message
	Programming the Instruction Message - 1835 System	36	3.4.3	* 81	Factory message
	Programming the User Message - 1837 System	37	3.4.4	* 80	Factory message
	Programming the Instruction Message - 1837 System	38	3.4.5	* 81	Factory message
Section 3.5 Programming Phone Numbers and Names					
	Programming the Directory Code Length	40	3.5.1	* 20	Three (3) digits
	Programming Directory Code AND 7-Digit Phone Numbers - No Area Code	40	3.5.2	* 01	No factory setting
	Programming Area Codes	41	3.5.3	* 24	No factory setting
	Programming Phone Numbers that need Area Codes	41	3.5.4	* 41	No factory setting
	Programming Names - 1835, 1837 Systems Only	42	3.5.5	* 66	No factory setting
	Deleting Individual Phone Numbers	42	3.5.6	* 01	No factory setting
	Delete Names - 1835, 1837 Systems Only	42	3.5.7	* 65	No factory setting
	Delete Area Codes	43	3.5.8	* 24	No factory setting
	Display Phone Numbers - 1835, 1837 Systems Only	43	3.5.9	* 06	No factory setting
	PBX Line Access Code Programming	43	3.5.10	* 09	No factory setting
	Touch-Tone Dialing Pause	43	3.5.11	* 27	1 (Pause ON)
Section 3.6 Programming Device Codes - 1833, 1835, 1837 Only					
	Programming Five-Digit Device Codes	44	3.6.1	* 70	No factory setting
	Delete Device Codes	44	3.6.2	* 71	No factory setting
	Enabling Facility Codes	44	3.6.3	* 72	No factory setting
	Programming Facility Codes	44	3.6.4	* 73	No factory setting
Section 3.7 Programming Four-Digit Entry Codes					
	Programming Four-Digit Entry Codes	45	3.7.1	* 02	No factory setting
	Delete Entry Codes	45	3.7.2	* 02	No factory setting
	Entry Code Ranges	45	3.7.3	* 12	No factory setting
Section 3.8 Anti-Pass Back					
	Programming the Anti-Pass Back Mode	46	3.8.1	* 43	No factory setting
	Re-Sync All Devices	46	3.8.2	* 45	No factory setting
	Re-Sync Individual Devices	46	3.8.3	* 46	No factory setting
	Reset Facility Counter	46	3.8.4	* 48	No factory setting

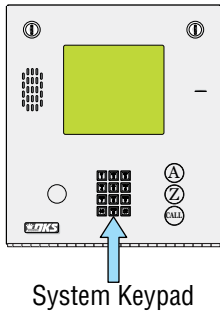
3.3 General Programming Using the System Keypad



















Proceed with the programming steps on the following pages **ONLY IF** PC programming **WILL NOT** be used. The system keypad may be used to program some features on the telephone entry system but can be a little tedious to use. We strongly suggest that you become familiar with the programming steps in each feature you want to use **BEFORE** actually programming the system.

Important Note: If you make a mistake while programming, press   keys at the same time to escape from programming no matter how much has been completed, then begin again at step 1.

3.3.1 Relay Strike Time

These steps will program Relay 0, Relay 1 and Relay 2 strike times. Strike times can be programmed from 1/4 second up to 99 seconds by entering the desired time in seconds as a two-digit number in step 3. If Expansion boards are going to be used with this system, set Relay 2 strike time to 00 for Expansion boards 1-8. If more than 8 Expansion boards are being used, set Relay 1 strike time to 00 (for Expansion boards 9-16) and then set Relay 0 strike time for the desired time in seconds. In this application, Relay 0 becomes the **PRIMARY** relay that will open the door or gate after the resident presses **9** on their telephone.











Factory setting for relay strike times are: Relay 0 = 01 (1 sec), Relay 1 = 01 (1 sec), Relay 2 = 01 (1 sec).

1. Press    and enter your four-digit MASTER CODE     (**beep**).
2. Press   (**beep**) to set **Relay 0**, OR   (**beep**) to set **Relay 1**, OR   (**beep**) to set **Relay 2** strike time.
3. Enter the **two-digit strike time** in seconds (00-99), then press  (**beep**).
(Example: 1/4 second - enter 00, 1 second - enter 01 etc.)
4. Repeat steps 2 and 3 to set other relay strike times.
5. Press   together to end this programming sequence (**beeeeeep**).

3.3.2 Talk Time

This programming sequence sets the maximum time allowed for conversation when the entry system places a call to the resident. The talk time can be set from 1 second up to 255 seconds (4 minutes, 15 seconds) and is entered as a three-digit number in step 3. The talk time set here **DOES NOT** affect the telephone numbers that are programmed under directory codes 0, 00, 000, 0000 and 1, 01, 001, 0001. The talk time for these two directory code sets are **factory set to the maximum**. Phone numbers programmed under these directory codes should be reserved for management or emergency phone numbers that generally require longer conversations.

Factory setting for talk time = 060 (60 seconds).

1. Press    and enter your four-digit MASTER CODE     (**beep**).
2. Enter the **three-digit talk time** in seconds (001-255), then press  (**beep**).
(Example: 1 second - enter 001, 20 seconds - enter 020 etc.)
3. Press   together to end this programming sequence (**beeeeeep**).

3.3.3 Tone Open Numbers

These steps will program the tone open numbers for Relays 0, 1 and 2. You will need to enter a four-digit number (see chart below) to set the relay functions. **If a function is not desired, enter # in place of a number.** If Expansion boards are connected to the system, there is no need to set a momentary open tone open number for the Expansion control relay(s). However, you may want to set HOLD and DEACTIVATE tone numbers, which will allow management to have a function to automatically unlock all doors/gates controlled by a Expansion board (refer to 5.3.2).

Factory setting is: Relay 0 = ####, Relay 1 = 9876, Relay 2 = 5432.

1. Press and enter your four-digit MASTER CODE (beep).
2. Press (beep) to set **Relay 0**, OR (beep) to set **Relay 1**, OR (beep) to set **Relay 2** tone numbers.
3. Enter the **four-digit tone open number code**, then press (beep).

(Example: If you want a relay to have a momentary activation function only, and you want that relay to momentary activate when the number 9 is pressed, enter 9 # # #. If a function is not desired, enter # in place of a number. Do not duplicate tone open numbers, Example: don't set relay 0, 1, and 2 tone-open numbers all to 9.)

4-Digit Tone Open Number Code	Function
1st Digit	Momentary activation. Relay will activate for the programmed strike time (3.3.1).
2nd Digit	Relay hold. Relay will activate and remain activated until commanded to release.
3rd Digit	Relay release. Deactivates the relay hold command.
4th Digit	Relay hold 1-hour. Relay will activate for 1-hour and then will automatically deactivate itself.

4. Repeat steps 2 and 3 to set other relay tone open numbers.
5. Press together to end this programming sequence (beeeeeep).

Note: Residents will only be able to activate the **Momentary activation** when using the entry system.

3.3.4 Switch Input Relay(s) Activation

This programming sequence sets which relay(s) will activate when the switch input (main terminals #4 and #6) is activated on the telephone entry system. The system can be programmed so that only one relay will activate, or any combination of relays will activate. TIP: The relay that you designate as the primary relay should be programmed to activate from the postal switch input.

Factory setting = 010 (only relay 1 activates)

1. Press and enter your four-digit MASTER CODE (beep).
2. Enter the **three-digit** (1's or 0's only) **postal relay code**, then press (beep).

Three-digit positions: 1st digit position - **Relay 0**, 2nd digit position - **Relay 1**, 3rd digit position - **Relay 2**.

To activate a relay - enter a 1 in a digit position.

To **NOT** activate a relay - enter a 0 in a digit position.













Example: entering 010 will cause only relay 1 to activate. Entering 101 will cause both relay 0 and relay 2 to activate.

3. Press together to end this programming sequence (beeeeeep).

3.3.5 Touch-Tone / Rotary-Dial

This programming sequence will set the telephone entry system to dial out in either a touch-tone or rotary format. Generally, this will be set for touch-tone.

Factory setting = touch-tone.

1. Press    and enter your four-digit MASTER CODE     (**beep**).
2. Press   (**beep**) for **touch-tone**, OR   (**beep**) for **Rotary**
3. Press   together to end this programming sequence (**beeeeeep**).

3.3.6 Rotary-Dial 9 Relay(s) Activation

This programming sequence sets which relay(s) will activate when the system receives a **rotary-dial 9 open command** from a resident's rotary telephone. The system can be programmed so that only one relay will activate, or any combination of relays will activate. TIP: The relay that you designate as the primary relay should be programmed to activate from a rotary 9 command.

Factory setting = 010 (only relay 1 activates)



1. Press    and enter your four-digit MASTER CODE     (**beep**).
2. Enter the **three-digit** (1's or 0's only) **rotary 9 code**, then press  (**beep**).

Three-digit positions: 1st digit position - **Relay 0**, 2nd digit position - **Relay 1**, 3rd digit position - **Relay 2**.

To activate a relay - enter a 1 in a digit position.

To **NOT** activate a relay - enter a 0 in a digit position.

Example: entering 010 will cause only relay 1 to activate. Entering 101 will cause both relay 0 and relay 2 to activate.

3. Press   together to end this programming sequence (**beeeeeep**).

3.4 Programming Letters, Numbers and Messages

Press... ..To Display

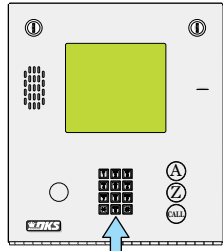
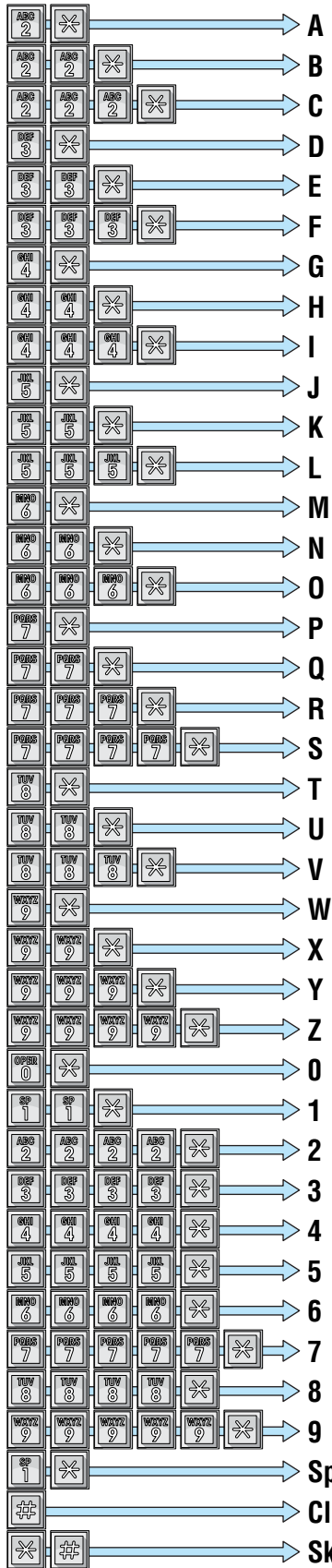

System Keypad

These programming steps apply only to the 1835 and 1837 systems with an LCD display. The keypad on these telephone entry systems have all the letters of the alphabet, the numbers 0 through 9, and a space key printed on it. This allows the keypad to be used to program all names and numbers into the systems electronic directory.

Note: Names should not be programmed from a remote location using a touch-tone telephone.

Note: Only upper case letters can be programmed using the keypad. Upper and lower case letters may be programmed using the Remote Account Manager Software (PC).

3.4.1 Programming Letters and Numbers from Keypad

When entering names into the electronic directory using the system keypad or a touch-tone telephone, pressing the key once will display the first letter listed on the button, pressing twice will display the second letter, pressing it a third time will display the third letter, and pressing it a fourth time will display the number (or fourth letter).



Example using the number 6 key:

Press **one time** to display the letter M, then press to enter it in the system.

Press **two times** to display the letter N, then press to enter it in the system.

Press **three times** to display the letter O, then press to enter it in the system.

Press **four times** to display the number 6, then press to enter it in the system.

This chart provides the sequence required to enter each letter and number from the keypad into the system memory. A sequence is also provided to add a space, clear the display if a mistake is made, and a sequence to skip a name if there is a desire **not** to provide a name with a phone number.

3.4.2 Programming the User Message – 1835 System

The user message, followed by the instruction message, **scrolls across the screen from right to left** when the system is not in use. Both the user and instruction message can be programmed to display your own message. The user message can be a **maximum of 48 characters (spaces count as a character)** and is entered into the system memory in three blocks. The first two blocks contain 20 characters while the third block contains 8 characters. The example below shows how the sample message was divided into three blocks. Use the blank table to organize your own message. Only upper case letters, numbers and spaces can be programmed from the system keypad.

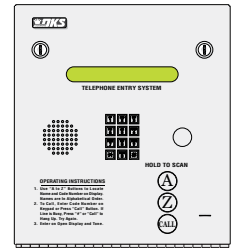

Factory Default User Message = This Space is For YOUR Scrolling User Programmable Message.

Example: THANK YOU FOR VISITING OAKWOOD CONDOMINIUMS																				
	1	2	3	4	5	6	7	8	9	10	11	12	13	14	15	16	17	18	19	20
Block 1	T	H	A	N	K		Y	O	U		F	O	R		V	I	S	I	T	I
Block 2	N	G		O	A	K	W	O	O	D		C	O	N	D	O	M	I	N	I
Block 3	U	M	S																	

Note: The factory default message was programmed from a PC, therefore upper and lower case letters are displayed.

	1	2	3	4	5	6	7	8	9	10	11	12	13	14	15	16	17	18	19	20
Block 1																				
Block 2																				
Block 3																				

After organizing the user message in the table above, follow the instructions below to enter the message into the system. After each desired letter, number or space is displayed on the directory, remember to press * to enter that character. Spaces count as a character and must be entered into memory as a character. After a complete block of characters (including spaces) has been entered, press * to enter the block, then start the next block.

1. Press and enter your four-digit MASTER CODE (beep).

The LCD display on the 1835 will read: BLOCK 1.

2. Enter the characters into block 1 (refer to 3.4.1 for reference). Remember to press (beep) after each character.

3. After the last character in block 1 has been entered, press (beep) to enter the entire block.

The LCD display will read: BLOCK 2.

4. Enter the characters into block 2. Remember to press (beep) after each character.

5. After the last character in block 2 has been entered, press (beep) to enter the entire block.

The LCD display will read: BLOCK 3.

6. Enter the characters into block 3. Remember to press (beep) after each character.

7. After the last character in block 3 has been entered, press (beep) to enter the entire block.

8. Press (beep) to enter all three blocks into the system memory.

9. Press together to end this programming sequence (beeeeeep).

10. The new user message will begin to scroll across the screen.

3.4.3 Programming the Instruction Message – 1835 System

The instruction message **scrolls across the screen from right to left** when the system is not in use and follows the user message programmed in 3.4.2. The instruction message can be a **maximum of 52 characters (spaces count as a character)** and is entered into the system memory in three blocks. The first two blocks contain 20 characters while the third block contains 12 characters. The example below shows how the sample instruction message was divided into three blocks and programmed into the system. Use the blank table to organize your own message. Only upper case letters, numbers and spaces can be programmed from the system keypad.

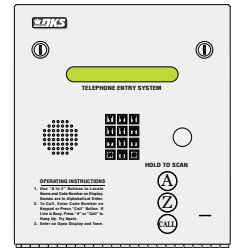

Factory Default Instruction Message: Push A-Z To Find Name Or No. Enter Code Or Push Call

Example: PUSH A OR Z BUTTON TO FIND NAME ENTER CODE OR PUSH CALL																				
	1	2	3	4	5	6	7	8	9	10	11	12	13	14	15	16	17	18	19	20
Block 1	P	U	S	H		A		O	R		Z		T	O		F	I	N	D	
Block 2	N	A	M	E		E	N	T	E	R		C	O	D	E		O	R		P
Block 3	U	S	H		C	A	L	L												

Note: The factory default message was programmed from a PC, therefore upper and lower case letters are displayed.

	1	2	3	4	5	6	7	8	9	10	11	12	13	14	15	16	17	18	19	20
Block 1																				
Block 2																				
Block 3																				

After organizing the instruction message in the table above, follow the instructions below to enter the message into the system. After each desired letter, number or space is displayed on the directory, remember to press * to enter that character. Spaces count as a character and must be entered into memory as a character. After a complete block of characters (including spaces) has been entered, press * to enter the block, then start the next block.

- Press and enter your four-digit MASTER CODE (beep).
The LCD display on the 1835 will read: BLOCK 1.
- Enter the characters into block 1 (refer to 3.4.1 for reference). Remember to press (beep) after each character.
- After the last character in block 1 has been entered, press (beep) to enter the entire block.
The LCD display will read: BLOCK 2.
- Enter the characters into block 2. Remember to press (beep) after each character.
- After the last character in block 2 has been entered, press (beep) to enter the entire block.
The LCD display will read: BLOCK 3.
- Enter the characters into block 3. Remember to press (beep) after each character.
- After the last character in block 3 has been entered, press (beep) to enter the entire block.
- Press (beep) to enter all three blocks into the system memory.
- Press together to end this programming sequence (beeeeeep).
- The new instruction message will begin to scroll across the screen.

3.4.4 Programming the User Message – 1837 System

The user message is displayed on the **top four lines** of the 1837 display. This message can be a **maximum of 80 characters (spaces count as a character)** and is entered into the system memory in four blocks. The example below shows how the sample message was divided into four blocks and **centered on the screen**. Use the blank table to organize your own message. Only upper case letters, numbers and spaces can be programmed from the system keypad.

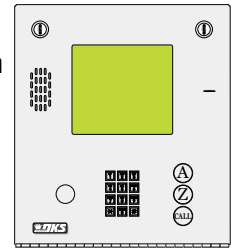

Factory Default User Message = This Space is For YOUR Centered User Programmable Message.

Example: WELCOME TO THE OAKWOOD CONDOMINIUMS PLEASE DRIVE CAREFULLY																				
	1	2	3	4	5	6	7	8	9	10	11	12	13	14	15	16	17	18	19	20
Block 1				W	E	L	C	O	M	E		T	O		T	H	E			
Block 2	O	A	K	W	O	O	D		C	O	N	D	O	M	I	N	I	U	M	S
Block 3					P	L	E	A	S	E		D	R	I	V	E				
Block 4						C	A	R	E	F	U	L	L	Y						

Note: The factory default message was programmed from a PC, therefore upper and lower case letters are displayed.

	1	2	3	4	5	6	7	8	9	10	11	12	13	14	15	16	17	18	19	20
Block 1																				
Block 2																				
Block 3																				
Block 4																				

After organizing the user message in the table above, follow the instructions below to enter the message into the system. After each desired letter, number or space is displayed on the directory, remember to press * to enter that character. Spaces count as a character and must be entered into memory as a character. After a complete block of characters (including spaces) has been entered, press * to enter the block, then start the next block.

- Press and enter your four-digit MASTER CODE (**beep**).
The LCD display on the 1837 system will read: BLOCK 1.
- Enter the characters into block 1 (refer to 3.4.1 for reference). Remember to press (**beep**) after each character.
- After the last character in the block has been entered, press (**beep**) to enter the entire block.
The LCD display will read: BLOCK 2.
- Repeat steps 2 and 3 to enter characters into block 2.
The LCD display will read: BLOCK 3.
- Repeat steps 2 and 3 to enter characters into block 3.
The LCD display will read: BLOCK 4.
- Repeat steps 2 and 3 to enter characters into block 4.
- Press (**beep**) to enter all four blocks into the system memory.
- Press together to end this programming sequence (**beeeeeep**).
- The new user message will be centered on the screen.

3.4.5 Programming the Instruction Message – 1837 System

The instruction message is displayed on the **bottom four lines** of the 1837 display. This message can be a **maximum of 80 characters (spaces count as a character)** and is entered into the system memory in four blocks. The example below shows how the sample message was divided into four blocks and **centered on the screen**. Use the blank table to organize your own message. Only upper case letters, numbers and spaces can be programmed from the system keypad.

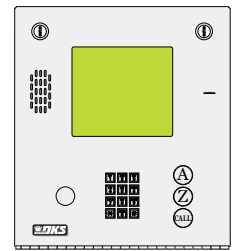

Factory Default Instruction Message: Use A-Z to Find Name Or Number - Enter Code On Keypad - Busy Press Any Key - Try Again.

Example: USE A Z TO FIND NAME ENTER CODE ON KEYPAD BUSY PRESS ANY KEY TRY AGAIN																				
	1	2	3	4	5	6	7	8	9	10	11	12	13	14	15	16	17	18	19	20
Block 1	U	S	E		A		Z		T	O		F	I	N	D		N	A	M	E
Block 2	O	R		N	U	M	B	E	R		E	N	T	E	R		C	O	D	E
Block 3	O	N		K	E	Y	P	A	D		B	U	S	Y		P	R	E	S	S
Block 4	A	N	Y		K	E	Y		T	R	Y		A	G	A	I	N			

Note: The factory default message was programmed from a PC, therefore upper and lower case letters are displayed.

	1	2	3	4	5	6	7	8	9	10	11	12	13	14	15	16	17	18	19	20
Block 1																				
Block 2																				
Block 3																				
Block 4																				

After organizing the instruction message in the table above, follow the instructions below to enter the message into the system. After each desired letter, number or space is displayed on the directory, remember to press * to enter that character. Spaces count as a character and must be entered into memory as a character. After a complete block of characters (including spaces) has been entered, press * to enter the block, then start the next block.

1. Press and enter your four-digit MASTER CODE (**beep**).

The LCD display on the 1837 system will read: BLOCK 1.

2. Enter the characters into block 1 (refer to 3.4.1 for reference). Remember to press (**beep**) after each character.

3. After the last character in the block has been entered, press (**beep**) to enter the entire block.

The LCD display will read: BLOCK 2.

4. Repeat steps 2 and 3 to enter characters into block 2.

The LCD display will read: BLOCK 3.

5. Repeat steps 2 and 3 to enter characters into block 3.

The LCD display will read: BLOCK 4.

6. Repeat steps 2 and 3 to enter characters into block 4.

7. Press (**beep**) to enter all four blocks into the system memory.

8. Press together to end this programming sequence (**beeeeeep**).

9. The new user message will be centered on the screen.

3.5 Programming Phone Numbers and Names

Before beginning manual programming of phone numbers and names from the system keypad, it is strongly recommended that the resident log sheets in the back of this manual be completed in their entirety. This will make programming easier and can be used as a reference when entering phone numbers, names, entry codes and device numbers.

This section of the manual will instruct you on how to enter phone numbers and names into the system memory from the keypad on the telephone entry system. Prior to entering any information, you will set the directory code digits to the desired length. **Changing the directory code length AFTER programming is complete will delete all programmed phone numbers, area codes, and names and will require you to re-enter this information.**































If you are in an area that requires 10 digit dialing, you will need to program the area code(s) required as described in 3.5.3, and then program the resident phone numbers as described in 3.5.4. If 10-digit dialing is not required, simply enter the 7-digit phone number as described in 3.5.2.

1835 and 1837 systems only. When you are entering names into the electronic directory, remember to press * after each desired letter, number, or space is displayed on the LCD screen. When the entire name is displayed on the directory, press * again to enter the entire name into the directory. If you make a mistake, simply press # to clear the display and start over.

Names cannot be more than 15 characters in length - spaces count as a character.

Only upper case letters, numbers, spaces and a clear function (in case you make a mistake) can be programmed from the system keypad.

Example of programming 12 characters: JONES APT 1

	Digit	Keypad Sequence	Programming Description
1	J	 	Press the 5 key one time to display J, then press the * key to enter the letter.
2	O	   	Press the 6 key three times to display O, then press the * key to enter the letter.
3	N	  	Press the 6 key twice to display N, then press the * key to enter the letter.
4	E	  	Press the 3 key two times to display E, then press the * key to enter the letter.
5	S	    	Press the 7 key four times to display S, then press the * key to enter the letter.
6		 	Press the 1 key one time for a space, then press the * key to enter the space.
7	A	 	Press the 2 key one time to display A, then press the * key to enter the letter.
8	P	 	Press the 7 key one time to display P, then press the * key to enter the letter.
9	T	 	Press the 8 key one time to display T, then press the * key to enter the letter.
10		 	Press the 1 key one time for a space, then press the * key to enter the space.
11	1	  	Press the 1 key twice to display 1, then press the * key to enter the number.
12			Press the * key to enter the entire name in the system.

Note: Refer to 3.4.1 on page 34 to reference how to program each individual letter, number, space, clear etc.

3.5.1 Programming the Directory Code Length

This programming sequence sets the directory code length to 1 - 2 - 3 or 4 digits.

When **10 to 99** resident names or telephone numbers are going to be programmed, the directory code **must be at least two-digits**, but can be 3 or 4 digits.

When **100 to 999** resident names or telephone numbers are going to be programmed, the directory code **must be at least three-digits**, but can be 4 digits.

When **1000 or more** resident names or telephone numbers are going to be programmed, the directory code **must be set to four-digits**.

Factory setting is three (3) digits.

CAUTION: This programming sequence will delete **ALL** phone numbers and directory codes that have been **previously** programmed into the system.

1. Press and enter your four-digit MASTER CODE (**beep**).
The LCD display on the 1835 and 1837 systems will read: # OF DIRECTORY CODE DIGITS
2. Enter 1, 2, 3 or 4 digits, then press (**beep**).
The LCD display will read: ERASE MEM? 1=Y 0=N
 - If there are **10 to 99** resident names or telephone numbers, directory code **must be at least two-digits**.
 - If there are **100 to 999** resident names or telephone numbers, directory code **must be at least three-digits**.
 - If there are **1000 or more** resident names or telephone numbers, the directory code **must be set to four-digits**.
3. Entering will cancel out of this program if desired (**beeeeeep**).
Entering will change the directory code length (**and erase ALL existing memory**).
The LCD display will read: ERASING
A long beep will sound when complete (**beeeeeep**).
Directory code digit length has now been programmed.

3.5.2 Programming Directory Codes with 7-Digit Phone Numbers - NO Area Code

In this programming sequence, the directory codes **AND** 7-digit phone numbers will be programmed into the system. Be sure you have programmed the directory code length that you desire as described in 3.5.1 above. **Changing the directory code length after programming the telephone numbers will erase all the numbers and directory codes that have been programmed.** To program phone numbers that will need to use an area code (long distance calls and 10-digit calling), program them in 3.5.4. If you use directory codes 0, 00, 000, 0000 and/or 1, 01, 001, 0001 remember that the talk time for these directory codes are factory set to the maximum and cannot be changed. Use these directory codes to program management or emergency phone numbers, which generally require longer conversation periods.

Note: If this telephone entry system is being used in **an area that requires 10-digit phone number dialing**, proceed to 3.5.3 and 3.5.4 to program the area code, phone number and directory code.

1. Press and enter your four-digit MASTER CODE (**beep**).
2. Choose and enter a **directory code** (1, 2, 3 or 4 digits depending on what was programmed in 3.5.1 above), then press (**beep**). (You cannot duplicate directory codes)
The LCD display on the 1835 and 1837 systems will read: PHONE#
3. Enter the **seven-digit phone number**, then press (**beep**).
Note: If the number that you are entering in this step is less than seven-digits, enter # in the empty spaces after the digits have been entered.
For example, if the system is connected to a PBX that requires four-digit extension numbers and you want to enter extension 2217, you would enter this number as 2217###, then press * (beep).
4. Press together to end this programming sequence (**beeeeeep**).

3.5.3 Programming Area Codes

Program area codes when 10-digit or long distance calling is required. “Up to 10” OR “up to 255” area codes can be programmed depending on how the system was programmed in section 3.2.2.

- Area code pointers set for “up to 10” area codes are referenced 0 – 9 in step 2 (for a total of 10).
- Area code pointers set for “up to 255” area codes are referenced 000 – 254 in step 2A (for a total of 255).

The actual area codes will be entered as a four-digit number (1 + the three digit area code). If area codes are being programmed to facilitate 10-digit calling requirements, precede the three-digit area code with #.

Note: 255 area codes are available on REV E and higher circuit boards. REV D and lower boards only have 10 area codes.

1. Press and enter your four-digit MASTER CODE (**beep**).
“Up to 10” programmed, LCD display on the 1835 and 1837 systems will read: 0 – 9 AAC POINTER
“Up to 255” programmed, LCD display on the 1835 and 1837 systems will read: 000 – 254 AAC POINTER
2. Enter a **single-digit area code pointer** (0 – 9 when set for up to 10 area codes), then press (**beep**).
The LCD display will read: 4 DIGIT AREA CODE
- 2A. Enter a **three-digit area code pointer** (000 – 254 when set for up to 255 area codes), then press (**beep**).
The LCD display will read: 4 DIGIT AREA CODE
3. Enter the **four-digit area code**, then press (**beep**).
For long distance calling requirements, enter 1 and the three-digit area code (1 + the three digit area code).
For 10-digit calling requirements, enter # and the three-digit area code (# + the three digit area code).
4. Repeat steps 2 and 3 to enter additional area codes. Remember to use a different area code pointer number for every additional area code entered. See the reference tables in back of this manual to assist you further.
5. Press together to end this programming sequence (**beeeeeep**).

3.5.4 Programming Directory Codes with Phone Numbers that use Area Codes

In this section, phone numbers that are referenced to an area code pointer (long distance and 10-digit dialing calls) will be programmed with the directory code. Be sure that the area code(s) have been programmed as described in the preceding section 3.5.3.

Note: If long distance or 10-digit dialing is **NOT** required, program the seven-digit telephone numbers in section 3.5.2.

1. Press and enter your four-digit MASTER CODE (**beep**).
The LCD display on the 1835 and 1837 systems will read: DIRECTORY CODE
2. Choose and enter a **directory code** (1, 2, 3 or 4 digits depending on what was programmed in 3.5.1), then press (**beep**).
(You cannot duplicate directory codes)
The LCD display will read: AAC POINTER
3. Enter a **single-digit area code pointer** (0 – 9 when set for up to 10 area codes), then press (**beep**).
The LCD display will read: PHONE #
- 3A. Enter a **three-digit area code pointer** (000 – 254 when set for up to 255 area codes), then press (**beep**).
The LCD display will read: PHONE #
4. Enter the **seven-digit phone number**, then press (**beep**).
Note: If the number that you are entering in this step is less than seven-digits, enter # in the empty spaces after the digits have been entered.
For example, if the system is connected to a PBX that requires a four-digit extension numbers and you want to enter extension 2217, you would enter this number as 2217###, then press * (beep).
5. Repeat steps 2, 3, and 4 to enter additional long distance phone numbers.
6. Press together to end this programming sequence (**beeeeeep**).

3.5.5 Programming Names - 1835 and 1837 Systems Only

In this section, names will be programmed into the system. Names are referenced to a phone number by entering the directory code that the person's phone number has been programmed to.

1. Press and enter your four-digit MASTER CODE (beep).
2. Enter the existing **directory code** (section 3.5.2 or 3.5.4) that the name will be assigned to (1, 2, 3 or 4 digits, section 3.5.1), then press (beep).
3. Enter the residents name, one character at a time, press (beep) after each character to enter it. Continue entering characters, pressing (beep) after each character until all characters have been entered.
The LCD display on the 1835 and 1837 systems will display each character after * is pressed.
Refer to 3.4.1 and 3.5 for reference to letters, spaces etc.
4. Press (beep) to enter the complete name.
The LCD display will go blank after * has been pressed.
3. Repeat steps 2, 3, and 4 to enter additional names.
5. Press together to end this programming sequence (beeeeeep).

3.5.6 Deleting Individual Phone Numbers

This programming sequence is used to delete a single phone number under a **known directory code**. Proceed to 3.5.7 to delete the resident name after deleting the phone number.

1. Press and enter your four-digit MASTER CODE (beep).
2. Enter the existing **directory code** (section 3.5.2 or 3.5.4) that the phone number has been assigned to (1, 2, 3 or 4 digits, section 3.5.1), then press (beep).
3. Press then press (beep).
4. Repeat steps 2 and 3 to delete additional phone numbers.
5. Press together to end this programming sequence (beeeeeep).

3.5.7 Delete Names - 1834, 1835 and 1837 Systems Only

This programming sequence is used to delete a resident name from the directory. These steps **WILL NOT** erase the resident telephone number from the system. Go to section 3.5.6 above to delete the resident telephone number.

1. Press and enter your four-digit MASTER CODE (beep).
2. Use the A and Z buttons to locate the name that is to be erased on the LCD screen, then press (beep).
3. Repeat step 2 to erase additional names.
4. Press together to end this programming sequence (beeeeeep).

3.5.8 Delete Area Codes

This program sequence deletes area code numbers that have been programmed into the system. Refer to section 3.2.2. for programming on step 2 or 2A.

1. Press and enter your four-digit MASTER CODE (beep).
“Up to 10” programmed, LCD display on the 1835 and 1837 systems will read: 0 – 9 AAC POINTER
“Up to 255” programmed, LCD display on the 1835 and 1837 systems will read: 000 – 254 AAC POINTER
2. Enter the **single-digit area code pointer** (0 – 9 when set for up to 10 area codes), then press (beep).
The LCD display will read: 4 DIGIT AREA CODE
- 2A. Enter the **three-digit area code pointer** (000 – 254 when set for up to 255 area codes), then press (beep).
The LCD display will read: 4 DIGIT AREA CODE
3. Enter , then press (beep).
4. Repeat steps 2 or 2A and 3 to delete additional area codes.
5. Press together to end this programming sequence (beeeeeep).

3.5.9 Display Phone Numbers - 1835 and 1837 Systems Only

Use this programming sequence to display phone numbers programmed **under known directory codes**, i.e. if you wanted to see what phone number was programmed under directory code 271. This programming sequence **WILL NOT** allow you to delete the phone numbers that are displayed.

1. Press and enter your four-digit MASTER CODE (beep).
2. Enter the existing **directory code** (section 3.5.2 or 3.5.4) that the phone number has been assigned to (1, 2, 3 or 4 digits, section 3.5.1), then press (beep).
The phone number programmed under the directory code that was just entered will be displayed on the LCD screen.
 - **If C C C C C C C is displayed** - this indicates that **NO** phone number has been programmed under the entered directory code.
 - **If the first digit is flashing** - this is the area code reference code and indicates that the number displayed is a long distance or 10-digit number.
3. To display additional phone numbers, press and repeat step 2 or proceed to step 4 to end programming.
4. Press together to end this programming sequence (beeeeeep).

3.5.10 PBX Line Access Code Programming

If the telephone entry system is connected to a **PBX telephone system** rather than a dedicated C.O. line, you may need to set the unit to dial a line access code prior to dialing the resident phone number. Typically, the line access code is “9”, but check with the PBX system administrator to be sure.

1. Press and enter your four-digit MASTER CODE (beep).
2. Enter the single-digit **line access code number**, then press (beep).
3. Press together to end this programming sequence (beeeeeep).

Note: To change a line access number, enter the correct number in step 2. To delete a line access number, enter # in step 2.

3.5.11 Touch-Tone Dialing Pause

During touch-tone dialing, the system (by default) places a 2 second pause after dialing a line access code (9 in a PBX system for example) and after the area code. For example: 9 (2 second pause) 1310 (2 second pause) 6450023

The 2 second pause can be removed by programming 0 into the steps below. In this example, the system would simply dial out the line access code (9), area code (1310) and phone number (6450023) without any pauses. 913106450023

Factory setting is 1 (pause ON).

1. Press and enter your four-digit MASTER CODE (beep).
2. Enter (beep) to turn the pause **OFF**, or enter (beep) to turn the pause **ON**.
5. Press together to end this programming sequence (beeeeeep).

3.6 Programming Device Codes

Device codes **MUST** be **five (5) digits in length** and are typically used for a remote Wiegand card reader or transmitter devices. Each device code that you enter must be assigned to a directory code that you select (that was programmed in section 3.5.2). Up to 25 device codes can be entered under a single directory code, up to a maximum of 8,000 total device codes for the entry system. The maximum number that can be programmed in is 65405. **You cannot duplicate device codes.**

3.6.1 Programming Five-Digit Device Codes

This program sequence enters device (card, transmitter, digital) codes into the system memory.

1. Press and enter your four-digit MASTER CODE (beep).
2. Enter the existing **directory code** (section 3.5.2 or 3.5.4) that the device code will be assigned to (1, 2, 3 or 4 digits, section 3.5.1), then press (beep).
3. Choose and enter a **five-digit device code**, then press (beep). (Maximum number that can be programmed in is 65405)
4. Repeat steps 2 and 3 to enter additional device codes. (You cannot duplicate device codes)
5. Press together to end this programming sequence (beeeeeep).

3.6.2 Deleting Device Codes

This program sequence deletes individual device codes.

1. Press and enter your four-digit MASTER CODE (beep).
2. Enter the existing **directory code** (section 3.5.2 or 3.5.4) that the desired device code has been assigned to (1, 2, 3 or 4 digits, section 3.5.1), then press (beep).
3. Enter the **desired five-digit device code**, then press (beep).
4. Repeat steps 2 and 3 to delete additional desired device codes.
5. Press together to end this programming sequence (beeeeeep).

3.6.3 Enabling Facility Codes

This program sequence allows you to use (**enable**) or not use (**disable**) facility codes.

1. Press and enter your four-digit MASTER CODE (beep).
2. Enter (beep) to **disable** facility codes, or enter (beep) to **enable** facility codes
3. Press together to end this programming sequence (beeeeeep).

3.6.4 Programming Facility Codes

This program sequence enters device facility codes into the system memory. Up to 10 facility codes (reference numbers 0 through 9) may be programmed. Valid facility codes are 000 – 255.

1. Press and enter your four-digit MASTER CODE (beep).
2. Enter the **single-digit first facility code reference number** (0 – 9), then press (beep).
3. Enter the **three-digit facility code**, then press (beep).
4. Repeat steps 2 and 3 to enter additional facility codes.
5. Press together to end this programming sequence (beeeeeep).

3.7 Programming Four-Digit Entry Codes

Four-digit entry codes are entered **ONLY** on the **Telephone Entry System Keypad** preceded by “#” to allow the resident access. **DO NOT** confuse a **FOUR-digit ENTRY code** with a **FIVE-digit DEVICE code** that is entered on a remote wiegand keypad (see previous page).

Each entry code that you enter must be assigned to a directory code that you select (that was programmed in section 3.5.2). Only **ONE** entry code can be programmed for each directory code. **You cannot duplicate entry codes.**

3.7.1 Programming Four-Digit Entry Codes

1. Press and enter your four-digit MASTER CODE (beep).
2. Enter the existing **directory code** (section 3.5.2 or 3.5.4) that the entry code will be assigned to (1, 2, 3 or 4 digits, section 3.5.1), then press (beep).
3. Choose and enter a **four-digit entry code**, press (beep).
4. Repeat steps 2 and 3 to enter additional entry codes. (You cannot duplicate entry codes)
5. Press together to end this programming sequence (beeeeeep).

3.7.2 Delete Entry Codes

1. Press and enter your four-digit MASTER CODE (beep).
2. Enter the existing **directory code** (section 3.5.2 or 3.5.4) that the desired entry code has been assigned to (1, 2, 3 or 4 digits, section 3.5.1), then press (beep).
3. Enter , then press (beep).
4. Repeat steps 2 and 3 to delete additional desired entry codes.
5. Press together to end this programming sequence (beeeeeep).

3.7.3 Entry Code Ranges

Four-digit entry codes can be made to activate relay 0, relay 1, or relay 2 or any combination of relays by programming **HI** and **LOW** ranges for each relay. Ranges between relays may overlap, which will cause more than one relay to activate if this is desired. For example, if the low boundary for relay-0 and relay 1 is 2000, and the hi boundary is 3000 for relay 0 and 4000 for relay 1, then entry codes between 2000 and 3000 will activate both relays, and entry codes between 3001 and 4000 will only activate relay 1.

1. Press and enter your four-digit MASTER CODE (beep).
2. Press (beep) to set **relay 0**, or (beep) to set **relay 1**, or (beep) to set **relay 2** boundary.
3. Enter the **four-digit LOW boundary**, then press (beep).
4. Enter the **four-digit HI boundary**, then press (beep).
5. Repeat steps 2, 3, and 4 to set the other relay boundaries.
6. Press together to end this programming sequence (beeeeeep).

3.8 Anti-Pass Back

The programming steps below will allow you to set up and program **some basic functions** for the anti-pass back feature (APB). However, **you must set up the IN and OUT relay programming table in the Remote Account Manager software**. Anti-Pass Back tables **cannot** be set from the system keypad. Refer to “Remote account manager for windows” manual 1835-066.

3.8.1 Programming the Anti-Pass Back Mode

Anti-Pass Back (APB) can be set to operate in one of **three different modes**. **PASSIVE APB** records an APB Violation and **will allow** entry or exit. **ACTIVE APB** records an APB Violation and **will not allow** entry or exit. **TRAP APB** records an APB Violation and **will allow entry but not exit**.

1. Press and enter your four-digit MASTER CODE (beep).
2. Enter for OFF, for PASSIVE, for ACTIVE or for TRAP, then press (beep).
3. Press together to end this programming sequence (beeeeeep).

3.8.2 Re-Sync All Devices

This programming step is used to **allow all cards one ‘move’** either in or out without causing an APB Violation to be recorded.

1. Press and enter your four-digit MASTER CODE (beep).
2. Press to Re-Sync ALL devices or press to NOT Re-Sync, then press (beeeeeep).
3. The programming sequence will end itself after all cards have been re-synced.

3.8.3 Re-Sync Individual Devices

This programming step is used to **re-sync a single card** only.

1. Press and enter your four-digit MASTER CODE (beep).
2. Enter the **five-digit device number**, then press (beep).
3. Press together to end this programming sequence (beeeeeep).

3.8.4 Reset Facility Counter

This programming step is used to **reset the facility counter**. The facility counter keeps track of the number of “IN’s” and “OUT’s” when using APB mode.

1. Press and enter your four-digit MASTER CODE (beep).
2. Enter a **five-digit number** that you want the count to start at, then press (beep).
Example: to start the count at 25, enter 00025.
3. Press together to end this programming sequence (beeeeeep).

SECTION 4 - ADJUSTMENTS

1830 Series Circuit Board

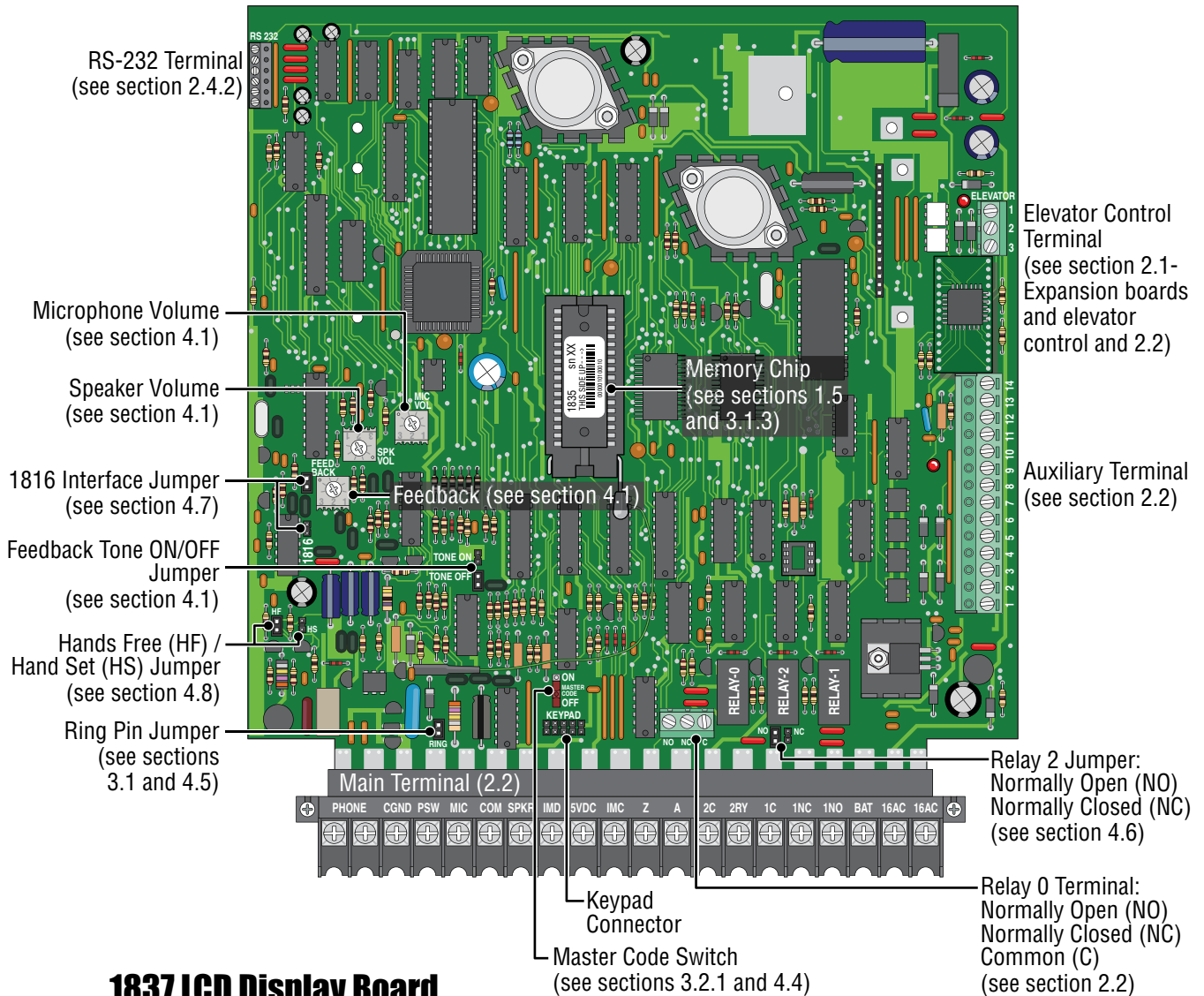

1837 LCD Display Board

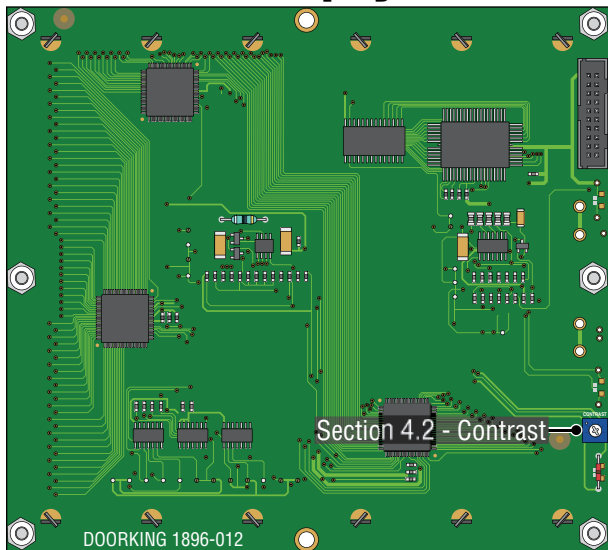

1835 (Wall), 1837 LCD Interface Board

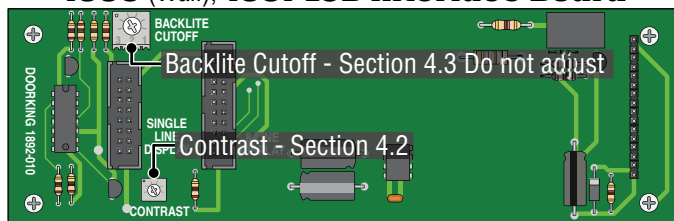

1835 LCD Display Boards (Surface, Flush)

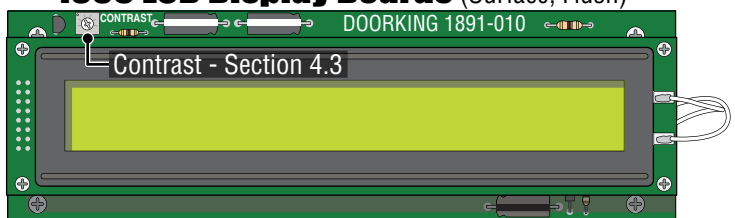

4.1 Speaker Volume, Microphone and Feedback

Speaker volume, microphone volume and feedback all interact with each other to affect the audio performance of the system.



1. Locate the **speaker volume**, **microphone volume** and **feedback** adjustments on circuit board (see previous page).

2. Set the **speaker volume** about 1/3 from full counter-clockwise.



3. Set the **microphone volume** to 1/2.

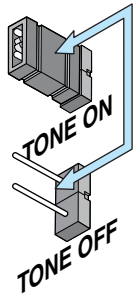

4. Place a phone call from the telephone entry system to a resident. If feedback occurs, turn the **speaker volume** counter-clockwise until it ceases.

5. While the resident is still on the line, ask them to remain silent. Move the **feedback tone ON/OFF jumper** to to the **ON** position. A tone will now be heard in the speaker. Rotate the **feedback** adjustment throughout its range while listening to the sound coming from the speaker. When the sound is minimum, this is the correct setting. Move the **feedback tone ON/OFF jumper** back to to the **OFF** position.

6. **Speaker volume** and **microphone volume** may now be adjusted to desired levels. If both are set too loud, feedback may result. For louder speaker volume, the microphone volume may need to be decreased. For louder microphone volume, the speaker volume may need to be decreased.



7. Normal setting for both **speaker volume** and **microphone volume** is about 1/2.

8. After setting these adjustments, place some test calls. If feedback occurs, microphone and/or speaker volume will need to be reduced.

4.2 LCD Display Contrast - 1835 and 1837

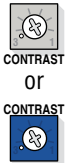

LCD display is adjusted at the factory and should **NOT** need to be re-adjusted. If it does, Let the system run for at least 10-minutes before making any display contrast adjustments.

1. Locate the **contrast** adjustment on your chosen model (see previous page).

2. Turn the contrast potentiometer clockwise to lighten, counter-clockwise to darken until the display is satisfactory.

4.3 Backlite Cutoff



This adjustment is **only** on the 1835 wall mounts and all the 1837 models. This is adjusted at the factory and should **NOT** be adjusted in the field.

4.4 Master Code Switch

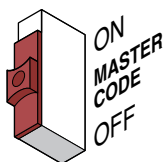

The master code switch **MUST** be kept in the **OFF** position for normal operation. Turn the master code switch **ON** only when programming the system's master code. See section 3.2.1 to program the system's master code. If the master code switch is **turned ON** and a new master code is **NOT** entered, the system will sound a long tone after approximately 30 seconds. This tone will continue every 30 seconds until a new master code is entered, or until the switch is turned off.

4.5 Ring Pin Jumper

Always Answer Calls

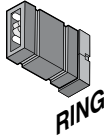

The ring pin jumper is labeled **RING** on the control board. This jumper **MUST** be installed to allow the system to **ALWAYS** answer the calls placed to it. If remote programming or remote relay operation is to be used, the jumper **MUST** be installed on the pins. Removing the jumper will cause the system to **NEVER** answer calls placed to it.

Never Answer Calls

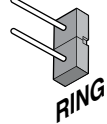

4.6 Relay 2 Jumper

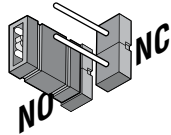

This jumper sets the contacts on relay number two at either Normally Open (NO) or Normally Closed (NC). The jumper is set to **NO from the factory**.

4.7 Auto – 1816 Interface Jumper

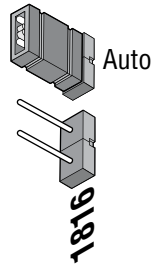

This jumper sets the system to operate as a **stand-alone unit - AUTO** (top position), or to interface with the 1816 Telephone Intercom System (bottom position). The jumper is set to **AUTO from the factory**.

4.8 HF – HS Jumper

SURFACE Mount Handsfree

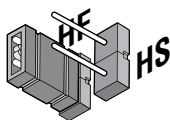
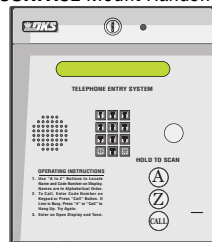

For **Hands Free (HF) operation**, the jumper is set in the left position.

SURFACE Mount Hand Set

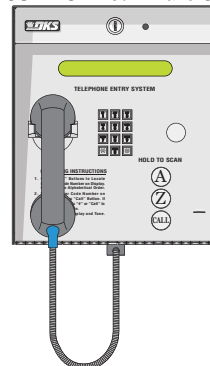

For a system with a **Hand Set (HS)**, the jumper is set in the right position.

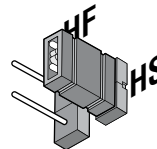

FLUSH Mount Hand Set

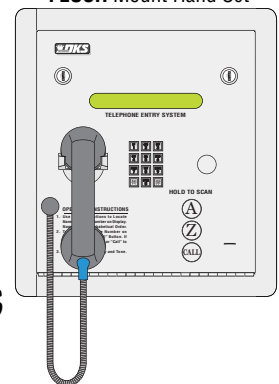

SECTION 5 - SYSTEM OPERATING INSTRUCTIONS

5.1 Guest Instructions

Operating Instructions are printed on most of the telephone entry systems. The systems with LCD displays have a scrolling or static **Instruction Message** on how to operate the system (locating and calling the resident that they wish to visit). The 1835 and 1837 systems utilize “**A**” and “**Z**” **scroll buttons** that a guest will use to locate the resident that they are wishing to visit. Pushing the “**A**” button will cause the resident directory to scroll up, pushing the “**Z**” button causes the resident directory to scroll down. Holding these buttons down will cause the system to scroll or page through the resident directory rapidly. Resident names are listed in the resident directory alphabetically.

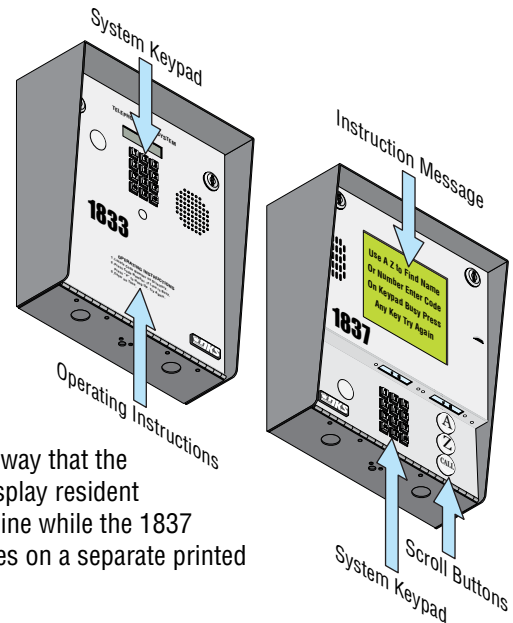

Although the systems are similar in the way that they operate, they differ in the way that the resident information is presented to the guest. The 1835 electronic directory display resident names (or apartment numbers) and their respective directory code on a single line while the 1837 system displays a page of eight resident names at a time. The 1833 system relies on a separate printed directory to provide guest with resident directory information.

1. If the guest knows the residents **directory code**, they can simply enter it on the system keypad to place a call.
2. If the guest does not know the residents directory code, they must check the directory and find the code assigned to the person they wish to visit.

1833 Systems - Guest must check the separate directory listing to locate the person they wish to visit to find their assigned directory code. They must then enter this code on the system keypad.

1835 Systems - Guest use the “**A**” and “**Z**” buttons to locate the name in the directory. Once the residents name is displayed, the guest presses the “**CALL**” button and the system will connect to the resident’s telephone. The guest may also enter the **directory code** on the keypad to place the call.

1837 Systems - Guest use the “**A**” and “**Z**” buttons to locate the name in the directory. When the desired resident’s name is displayed on the page, the “**A**” and “**Z**” buttons are used to move the PUSH CALL cursor up and down. When the PUSH CALL cursor is flashing on the desired resident’s name, the guest then can press the “**CALL**” button and the system will connect to the resident’s telephone. The guest may also enter the **directory code** on the system keypad to place the call.

If the resident’s line is busy, the system will emit a busy signal. If this happens, the guest can press the # key or the “**CALL**” button to hang up and then try again. Residents can avoid missing calls from guests at the telephone entry system by ordering call waiting from the local telephone company.



DTMF Tones - The telephone entry system can output **DTMF** tones from the keypad **AFTER** a call has been answered.





- If the  key is pressed by itself – the system will hang-up.

Example:  = hang-up.

- If any key is pressed prior to the  key, then **ALL** keys pressed will emit DTMF tones.

Example:      = DTMF tones for all buttons including the  key.

- If there is more than a 2-second delay between numbers and the  key, then the  key will hang-up the system.

Example:     more than a 2-second delay  = hang-up.

5.2 Resident Instructions

Resident control of the door or gate that the telephone entry system controls is limited to opening the door or gate in response to a call from a guest, or they may open the door or gate by using their assigned four-digit entry code. **A resident instruction sheet is included in the back of this manual and may be copied and passed out to your residents.**

5.2.1 Responding to a Guest Call

When communication is established, the resident has the option of **opening the door(s) or gate(s)** by pressing the programmed **tone open number(s)** on their touch tone telephone, or they can **deny access** to their guest by pressing **#** on their telephone. If access is granted, the resident will hear a confirmation tone in their handset indicating that the door or gate has opened, then the system will automatically hang up.



Residents should be instructed by management to always press the # key on their telephone if they wish to deny a guest access. If a resident hangs up to deny access instead of pressing #, the telephone entry system will remain on line until its programmed talk time expires or until it detects dial tone.

Some newer type telephones emit a short tone rather than a continuous tone when their keys are pressed. This may cause the telephone entry system to not respond to the tone open number. If this happens, simply press the tone open number twice in rapid succession to open the door or gate.

If a resident is using a rotary dial telephone, they will grant access to their guest by dialing **9**. To deny access to their guest, residents with rotary phones **MUST** simply hang up.

5.2.2 Using an Entry Code

Four-digit entry codes provide a means for a resident to gain access by entering their assigned code on the telephone entry system keypad. The four-digit entry code will operate relay 0, 1 or 2 depending on the boundaries that have been programmed into the system (section 3.7.3).

1. To use entry codes, first press  and then enter the **four-digit entry code** .
2. The system will emit a tone (**beep**) and the LCD display will show **OPEN** when a valid code is entered on the keypad.

If management decides to utilize resident entry codes, **residents should be instructed to keep their unique code secret.** Telling other persons their code or allowing other persons to use their code **compromises security** and defeats the purpose of the system.

5.3 System Administrator

The administrator can perform the following operations from a remote location using a touch tone telephone. You must know the **phone number of the system** and the **system master code**. The system **MUST** be setup to accept incoming calls, see sections 3.1 and 4.5.

5.3.1 Connecting to the Telephone Entry System from a Remote Location

1. Call the telephone number that the entry system is installed on. The system will answer with a short tone (beep) after two rings.
2. Press ***16** and enter the **four-digit MASTER CODE** _ _ _ _ (beep). The beep indicates system has accepted master code.
3. Press the desired **tone open** number _ (beep).

Note: Refer to section 3.3.3 to determine which tone open features have been programmed, i.e. momentary open, hold open, release, hold open one hour and then release.

4. Hang up.

5.3.2 Expansion Board Override HOLD OPEN Command

The Expansion board override command is used when expansion boards are connected to the system. This command will cause ALL expansion boards connected to the telephone entry system to **OPEN** or **UNLOCK** the gate or door that they are controlling, and will remain in this state until commanded to return to normal operation. This feature is useful when management wants to open all gates or unlock all doors - perhaps during an emergency situation as an example.

Note: Hold open tone numbers must be programmed for the override command to be functional. See section 3.3.3.

1. Call the telephone number that the entry system is installed on. The system will answer with a short tone (beep).
2. Press ***16** and enter the **four-digit MASTER CODE** _ _ _ _ (beep).
3. Press the **hold open** tone number that was programmed in section 3.3.3 _ (beep).
4. Hang up.
5. To release the override hold command and return the system to normal operation, repeat steps 1 through 4. In step 3, enter the **DEACTIVATE** tone number in place of the **HOLD OPEN** tone number.

5.3.3 Relay Check

The telephone entry system can be called and a check can be made to determine if any of the relays in the system are in a "hold open" mode. This check can be useful if your gate (or door) is held open and you suspect that the telephone entry system relay may be the cause.

1. Call the telephone number that the entry system is installed on. The system will answer with a short tone (beep).
2. Press ***16** and enter the **four-digit MASTER CODE** _ _ _ _ (beep).
3. The system will emit a series of short tones if the relay is in a **continuous activation mode**:

Relay 1 activated: **beep** - pause - **beep** - pause . . .

Relay 2 activated: **beep beep** - pause - **beep beep** - pause . . .

Relay 0 activated: **beep beep beep** - pause - **beep beep beep** - pause . . .

Note: Relay 0 is **Not** available for the 1834.

4. Press the programmed tone number _ to **deactivate** the relay (beep). The system will automatically hang up.

5.3.4 Time and Date Check

This operating functions lets you check the current date, time and day of the week that the system is currently programmed to. If the calendar chip in the system is **NOT** programmed, the system will emit a long **beeeeeep** when this function is entered on the telephone entry system keypad.

Note: The calendar chip can **ONLY** be programmed by the PC when communication is established either by modem or the RS-232 terminal.

1. Press ***30** and enter the **four-digit MASTER CODE** _ _ _ _ (beep).

The LCD display will show: The date - Month / Day / Year

The time - Hours / Minutes / AM or PM (AM=0, PM=1)

The day of the week (1=Sunday, 7=Saturday).

This information will be displayed for approximately four-seconds, then the LCD display will return to normal.

5.4 Miscellaneous Operating Instructions

5.4.1 Talk Time

The talk time for directory codes 0, 00, 000, 0000 and 1, 01, 001, 0001 is **factory set to 4 minutes 15 seconds** and cannot be changed. These directory codes should be reserved for use with management or emergency phone numbers that typically require longer talk times. For example, if directory code 000 was programmed to call a management phone number, the system will allow the **full 4 minutes and 15 seconds of talk time before automatically ending the call.**

5.4.2 Telephone Line Sharing

More than one telephone entry system **can share the same phone line** provided the units have been programmed for **multiple systems** on the same line (see section 3.2.9). When the unit is programmed for multiple systems sharing the phone same line, it checks the phone line for 48 volts (not busy) before attempting to place a call. If the phone line is in use, the system will emit a busy signal. If two or more systems are sharing the same phone line, it is important that each system be programmed with **its own unique master code**. When more than one system is sharing the same phone line, and a call is placed from one of those systems to a resident, **ONLY the system that placed the call** will respond to the **tone open** number that will be sent back to the unit from the resident's phone. Other units sharing the same phone line **WILL NOT** respond to the tone open number sent from the resident's phone.

5.4.3 Connection to a PBX System

If the telephone entry system is going to be connected to a PBX system, you may need to program extension numbers in place of a seven-digit telephone number. To do this, enter the extension number and fill the remaining spaces with the “#” key in the phone number programming step. For example, if the PBX system uses four-digit extensions, and you want to program extension 2217 as a phone number in step 3 of section 3.5.2, press: **2 2 1 7 # # # * (beep)**.

If the PBX system requires you to dial 9 to obtain an outside line, and you want to program some, but not all, outside line phone numbers in the system, program the number “9” as **one of the alternate area codes** in step 3 of section 3.5.3: press: **9 # # # * (beep)**.

Then program the outside phone number as a long distance number (section 3.5.4) using the area code reference number that was used to program the number “9”.

5.4.4 Areas with 10-Digit Dialing

If the telephone entry system is installed in an area where the telephone company has instituted 10-digit dialing, simply program the required number of alternate area codes into the system without preceding the area code with the number 1. If **310** was one of the area codes required in step 3 of section 3.5.3 press: **3 1 0 # * (beep)**.

Then program the outside phone number as a long distance number (section 3.5.4) using the area code reference number used to program **310**. Program additional area codes and phone numbers as described in sections 3.5.3 and 3.5.4.

SECTION 6 - MAINTENANCE

The DoorKing telephone entry system is essentially a maintenance free device. When the unit is properly installed, it should provide years of trouble free service. Maintenance is limited to updating the directory and phone number and/or entry codes when residents move in or out.

The faceplate of the unit should be cleaned on a regular basis to keep contaminants in the air from sticking to the surface and possibly causing pitting. When cleaning the faceplate of the system, never use an abrasive cleaner or cloth. Stainless steel cleaner works very well with a soft cloth for systems with a stainless steel faceplate. A clean damp soft cloth should be used to clean gold plated faceplates.

6.1 Troubleshooting

If problems should develop with your telephone entry system, refer to the trouble-shooting guide on the following pages to try and correct any problems. Our experience has shown that a majority of reported problems are actually programming related and can be corrected on site. If problems persist and they cannot be corrected, contact your authorized DoorKing dealer for assistance. Before performing any trouble-shooting, check the following:

1. Have a good VOM meter handy to check voltages and continuity.
2. Have a telephone test set (DoorKing P/N 1800-050 or equivalent) to check the telephone line. Noise on the phone line will cause problems with the entry system.
3. Be sure that the entry system case is properly grounded.
4. Be sure that the telephone wires are twisted.
5. A hum on the system indicates that the phone line or 16.5 VAC power lines may be grounded. Check to be sure that the phone lines or power lines are not shorted to ground.
6. Check the 16.5 VAC system power. Be sure that the transformer is properly rated (20 VA for 1833 and 1835 systems; 40 VA for 1837 systems). Keep the wire run from the transformer to the entry system as short as possible. Use 16 or 18 AWG, 600 volt insulated wire only. The importance of proper power wiring cannot be over stressed!
7. Isolate the telephone entry system. Disconnect any external devices, such as expansion boards, elevator control boards, RS 232 connection, card readers, RF receivers, keypads, etc. which may affect the operation of the system.

Symptom	Possible Solution(s)
Cannot get into programming mode.	<ul style="list-style-type: none">• Wrong master code entered. Start over.• Waiting too long between pushing buttons. Enter information quicker.• Keypad is not plugged into board correctly. Cable points down.• Memory chip is installed upside down.
System emits a long tone and cancels programming.	<ul style="list-style-type: none">• Waiting too long between pushing buttons.• Forgetting to press # first when programming.
Keypad is dead.	<ul style="list-style-type: none">• No power. Check for 16.5 VAC input power.• Check that the keypad is properly connected to the circuit board. The cable on the plug points down when connected to the circuit board.
LCD is unreadable.	<ul style="list-style-type: none">• Adjust contrast (4.2).

Symptom	Possible Solution(s)
Buzz or noise on the phone line.	<ul style="list-style-type: none"> • Disconnect the phone line from the system and check it with a handset. If line is noisy, problem is with the phone line and not the entry system. • Check for any shorts to ground behind the circuit board. • Check for pinched wires near the door hinge. • Check for 16-volt power shorted to ground. • Check for phone line shorted to ground. • Check that phone wires are twisted. • Check that the proper type of phone wire was used for an outdoor and / or underground application. • Check that all wires, speaker, keypad, etc. are isolated from ground. • Check that the cabinet is properly grounded. Be sure that case ground (terminal 3) is not used as a low voltage common. • Check for excessive voltage drop on 16 VAC power.
Ringing or howling from the speaker.	<ul style="list-style-type: none"> • Feedback improperly adjusted (4.1). • Volume is set too high (4.1).
After dial out, dial tone is heard on the speaker.	<ul style="list-style-type: none"> • Phone line is a rotary-dial line. Have the phone company change it to a touch-tone line.
Door strike locks on.	<ul style="list-style-type: none"> • Excessive voltage-drop on 16 VAC line. • Using a transformer with too low VA rating. • Relay strike time programmed too long (3.3.1).
Door strike or gate operator holds open.	<ul style="list-style-type: none"> • System was given a hold open command. Call the system and press the tone deactivate number (5.3.1).
Entry system will not answer when called.	<ul style="list-style-type: none"> • Ring pin is not installed (4.6). • Bad phone line or insufficient ring voltage.
Touch-tone 9 will not activate relay.	<ul style="list-style-type: none"> • Re-program tone-open number to 9 (3.3.3). • If resident phone emits a short pulse rather than a long tone, press 9 twice in rapid succession “99”. • Try another phone that is known to work. • Lower speaker volume (4.1) and re-adjust feedback (4.1).
Relay activates but gate operator will not open.	<ul style="list-style-type: none"> • Re-program relay strike time for a longer period (3.3.1). • Check wiring to gate operator. • Check gate operator.
Postal switch will not activate relay.	<ul style="list-style-type: none"> • Be sure that the wire-tie has been clipped off the postal switch. • Be sure that the relay has been programmed for postal switch input (3.3.4).
Four-digit entry codes will not work.	<ul style="list-style-type: none"> • Forgetting to press “#” first. • Re-program the entry code ranges (3.7.3).
Entry codes will not activate relay 0.	<ul style="list-style-type: none"> • Re-program relay 0 low and high ranges (3.7.3).
Entry codes will not activate relay 1.	<ul style="list-style-type: none"> • Re-program relay 1 low and high ranges (3.7.3).
Entry codes will not activate relay 2.	<ul style="list-style-type: none"> • Re-program relay 2 low and high ranges (3.7.3).
System emits a beep every 30 seconds.	<ul style="list-style-type: none"> • Master code switch is in the ON position (4.4).
DTMF tones are heard 15 seconds after call is answered.	<ul style="list-style-type: none"> • The system CALL-UP feature is turned on. Re-program this feature to turn it off (3.2.3).

6.1.1 RS-232 Test

This test procedure will check the RS-232 hardware to determine a **PASS** or **FAIL** mode. You will need two short pieces of wire to perform this test (jumpers). Connect the jumper wires as shown to the RS-232 terminal.

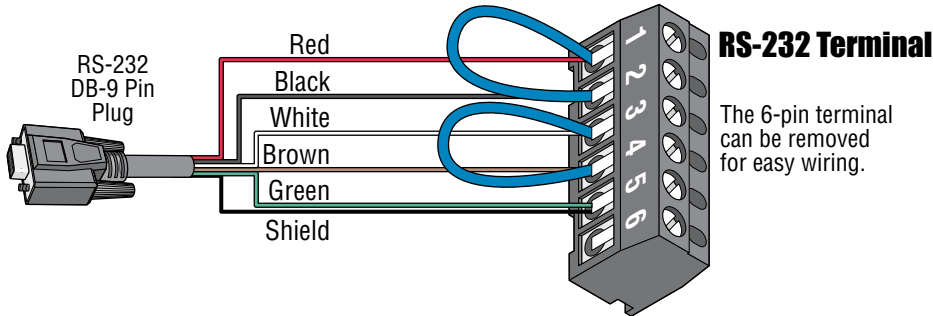

1. Press and enter your four-digit MASTER CODE (beep).
2. Press (beep).

PASS - The LCD display will indicate: **RS232 HARDWARE PASS**. One long tone will be heard: (**Beeeeeeep**).

FAIL - The LCD display will indicate **RS232 HARDWARE FAIL**. Two short tones and a long tone will be heard: (**Beep - Beep - Beeeeeeep**).

3. Remove the jumper wires from the terminal after performing this test.

6.1.2 Wiegand Test - 1835 and 1837 Systems Only

This programming sequence will allow you to view the wiegand data on the LCD display as it is received by the control board. This will allow you to verify that the 26, 30 and 31-bit wiegand device is functioning properly.

1. Press and enter your four-digit MASTER CODE (beep).
2. Enter .
3. Activate one of the wiegand input devices by placing a card on a card reader, pressing a transmitter button, or entering a digital code on a wiegand keypad.
4. If the wiegand data is shown on the LCD display, this verifies that the wiegand device is operating properly and sending the information to the entry system. If **NO** data appears on the display, the wiegand devices are **NOT** functioning.
5. Press to cancel the wiegand test mode. (**beeeeeep**).

6.1.3 Elevator Board(s) Hardware Test - 1835 and 1837 Systems Only

This programming sequence is designed for troubleshooting the elevator control board(s) that may be connected to the telephone entry system. This sequence will take approximately four (4) minutes to complete and will check the operation of the CALL relay, all the odd numbered relays, then all the even numbered relays on the elevator control board(s). This test confirms communication between the telephone entry system circuit board and the elevator control board(s).

1. Press and enter your four-digit MASTER CODE (beep).
2. The LCD display will show: **WHICH ELEVATOR?**
3. Enter the elevator shaft number (1, 2, 3 or 4) _, then press (beep).

The LCD display will show: **ELEVATOR TEST 1**.

Once the test starts, the CALL relay (LED ON) will activate, then **ALL odd numbered relays** will activate. After that, **ALL even numbered relays** will activate on the 1st elevator control board. After this sequence, if more than one elevator control board is connected, ALL odd numbered relays, and then ALL even numbered relays will activate on the 2nd elevator control board. This sequence will repeat itself up to ten (10) times depending on the number of elevator control boards connected.

4. Once the test is complete (approximately 4 minutes), this programming sequence will automatically end itself.

6.1.4 Elevator Board / Floor Hardware Test - 1835 and 1837 Systems Only

This testing sequence will allow you to check activation of individual relays on the elevator control board(s) and will confirm communication between the telephone entry system circuit board and the elevator control board(s).

1. Press and enter your four-digit MASTER CODE (beep).

The LCD display will show: **WHICH ELEVATOR?**

2. Enter the elevator shaft number (1, 2, 3 or 4) , then press (beep).

The LCD display will show: **FLOOR?**

3. Enter the **two-digit floor number** , then press (beep).

Note: First floor is entered 01, fifth floor is entered 05 etc.

4. The relay LED on the elevator control board that represents the floor number entered will **turn ON** for approximately 1 second.

5. To check other floor relays, repeat steps 2 and 3.

6. Press TOGETHER to end this programming sequence (beeeeeep).

Note: This program test sequence will automatically end itself if no keypad inputs are detected after approximately 30 seconds.

Refer to the Elevator Control board installation manual for more information on troubleshooting the elevator control boards.

6.1.5 Automatic Hang-up Options - 1835 and 1837 Systems Only

This sequence will allow you to program different methods by which the telephone entry system will hang-up if a resident denies a guest access by hanging up their telephone rather than pressing the “#” key to terminate the call.

Factory setting is 1, dial tone detect ON.

1. Press and enter your four-digit MASTER CODE (beep).

The LCD display will show: **0=N 1=DT 2=SIL 3=BTH.**

0 – BOTH OFF. Unit hangs up after programmed strike time runs out.

1 – DIAL TONE detect ON. Unit hangs up after detecting 5-seconds of dial tone.

2 – SILENCE detect ON. Unit hangs up after detecting 15-seconds of silence.

3 – BOTH ON.

2. Enter the **hang-up option code** (0, 1, 2 or 3), then press (beep).

3. Press TOGETHER to end this programming sequence (beeeeeep).

6.1.6 Modem Output Level Adjustment

This programming step should only be used if you are experiencing modem trouble. It allows you to adjust the output level of the modem tones. A higher modem level number increases the tone volume while a lower number decreases tone volume. 1-Min, 8-Max.

Factory setting is 4.

1. Press and enter your four-digit MASTER CODE (beep).

2. Enter the single-digit modem level number (1-8), then press (beep).

3. Press TOGETHER to end this programming sequence (beeeeeep).

6.1.7 Display IM Server Client Phone Number or System ID Number

This will allow you to see the client issued 10-digit phone number or system ID number that has been programmed into the telephone entry system.

1. Press and enter your four-digit MASTER CODE (beep).

The LCD display will show the 10-digit phone number or system ID number.

Note: The display will show C's (C C C C C C C C C C) if a phone number or system ID has **NOT** been programmed.

6.1.8 Test Connection to IM Server Client

This will allow you to test the connection to the IM Server Client or display problems that may have occurred.

1. Press and enter your four-digit MASTER CODE (beep).

The LCD display will show one of the following and the entry system will BEEP accordingly:

System is Registered - (beep) one beep

- System is registered and communication to the server is good.

Check Registration - (beep-beep) two beeps

- Make sure your registration is current and this system is set to IM Server Client on the registration screen. Also, be sure that the system phone number or ID number and the master code are set the same on the server and the entry system.

Program 10 Digit ID - (beep-beep-beep) three beeps

- There is not a valid 10-digit ID in the system memory. (see section 3.2.10)

Turn Client Mode On - (beep-beep-beep-beep) four beeps

- There is a valid 10-digit ID, but Client Mode is turned OFF. (see section 6.1.9)

No Server Contact - (beep-beep-beep-beep-beep) five beeps

- Communication to the server could not be made.

Note: If there is pending data to be transferred when this test is performed, the data transfer will occur.

6.1.9 Turn IM Server Client Mode OFF or ON

Use the following sequence to turn the Client Mode **OFF** or **ON**. If you are going to use the RS232 connection for any other RS232 functions other than Client Mode (e.g., connecting a PC directly to the entry system via the RS232 terminal), the Client Mode must be turned **OFF**. The Client Mode must be **ON** to use the system in Client Mode. **Note:** When section 3.2.10 (IM Server Client System Phone Number or System ID Number) is programmed, the client mode is automatically turned **ON**. If there is **NOT** a valid 10 digit system phone number or system ID number in memory, the system will emit three (3) short beeps. **Beep ... Beep ... Beep**

1. Press and enter your four-digit MASTER CODE (beep).
2. Press (beep) to turn **OFF**, OR (beep) to turn **ON**.
3. Press together to end this programming sequence (**beeeeeep**).

Note: You can test the telephone entry system connection to the IM server and analyze problems that may occur using section 6.1.8.

6.2 Accessories

Surface Mount Recess Kit

Use to recess a surface mount unit into a wall or column. P/N 1803-150.

Flush Mount Kit

Use to install flush style units into a wall or column. Kit includes rough-in back box and trim-ring. P/N 1814-165 comes with stainless steel trim ring. P/N 1814-166 comes with gold plated trim ring.

Flush Mount Surface Mounting Kit

Use to surface mount a flush style unit. P/N 1814-152.

Stainless Steel Case

Replaces the black steel surface mount case with a stainless steel case. P/N 1810-102.

Surge Suppressors

Phone line suppressor. P/N 1878-010.

Low voltage (28 V) suppressor. P/N 1878-010.

High voltage (115 V) suppressor. P/N 1879-080.

Mounting Posts

Heavy-duty goose-neck mounting post with mounting plate. P/N 1200-038.

Heavy-duty goose-neck mounting post with concrete base plate for pad mounting. P/N 1200-037.

Designer Style mounting posts; offset P/N 1200-086, straight P/N 1200-085.

Mounting Kiosk, for flush mount units only; P/N 1200-170.

Tracker Expansion Board

Expansion boards (P/N 2358-010) allow the 1833, 1835 and 1837 system to operate up to 24 individual doors or gates, provides door ajar and forced entry alarms, and can activate local and building alarm systems. Also allows DoorKing gate operators to report gate operator data and activity to the entry system.

Elevator Board

Elevator control boards (P/N 2348-010) provide control of up to four elevators, with each elevator having a maximum of 64 floors.

RS-232 Cable

RS-232 cable with DB-9 connector on one end and wires on the other end. Use this cable to program the entry system from a PC using RS-232 communications instead of the modem. P/N 1818-040.

TCP/IP Converter Kit - Third Party Connection

Enables the 1830 series system to send and receive data via the Internet or a LAN. P/N 1830-185.

TCP/IP Converter Kit - DoorKing IM Server Connection

Enables the 1830 series system to send and receive data via the DKS Internet Server. P/N 1830-186.

RS-422 Adapter Kit

Enables the 1830 series system to send and receive data to a PC. P/N 1840-055.

Wireless Adapter

Enables the 1830 series system to send and receive only data (no voice communication) to a PC without a cable connection. P/N 1815-521 - Base, P/N 1815-522 - 1 Remote, 1815-523 - 2 Remotes, 1815-524 - 3 Remotes.

Yagi High-Gain Antenna

Use with the wireless adapter to send and receive data much farther to a PC than the wireless adapter's antenna. P/N 1815-741.

Telephone Test Set

Includes clips, cord and carrying case. P/N 1800-050.

Battery

12 volt .8 amp hour gel cell provides stand by power during power interruptions. P/N 1801-008.

1833 Wiring Schematic: Surface - Flush

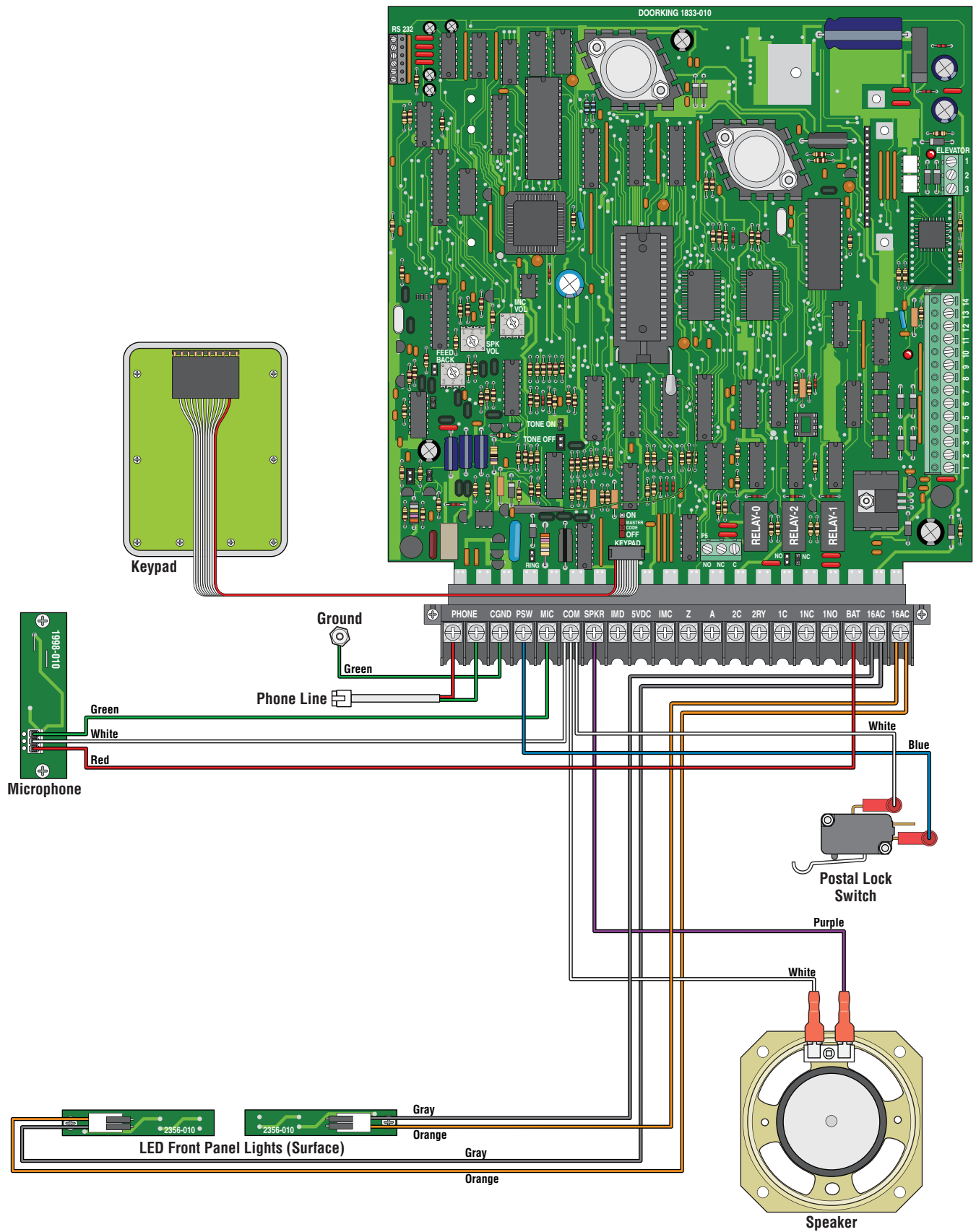

1835 Wiring Schematic: Surface - Flush - Wall

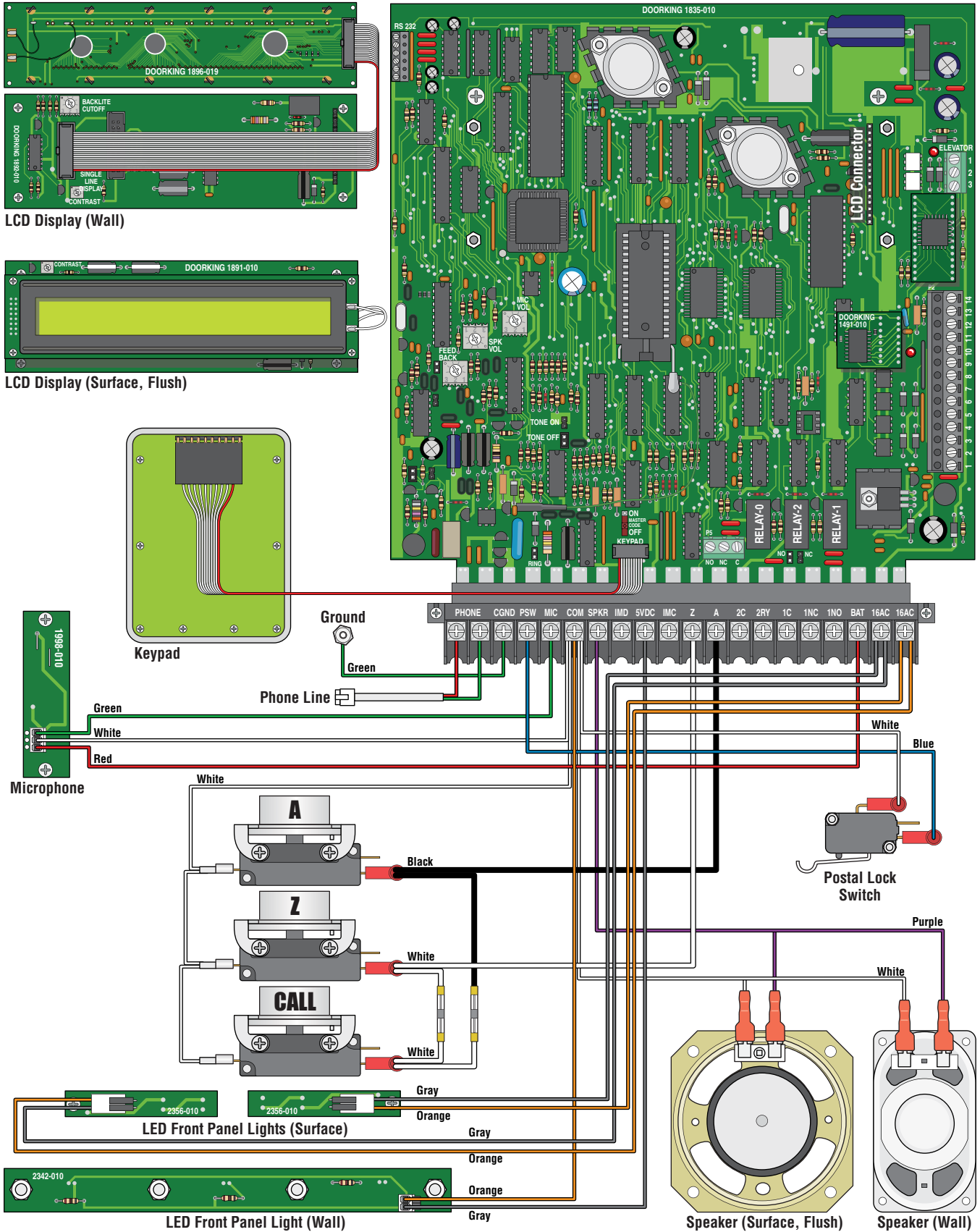

1837 Wiring Schematic: Surface - Flush - Wall

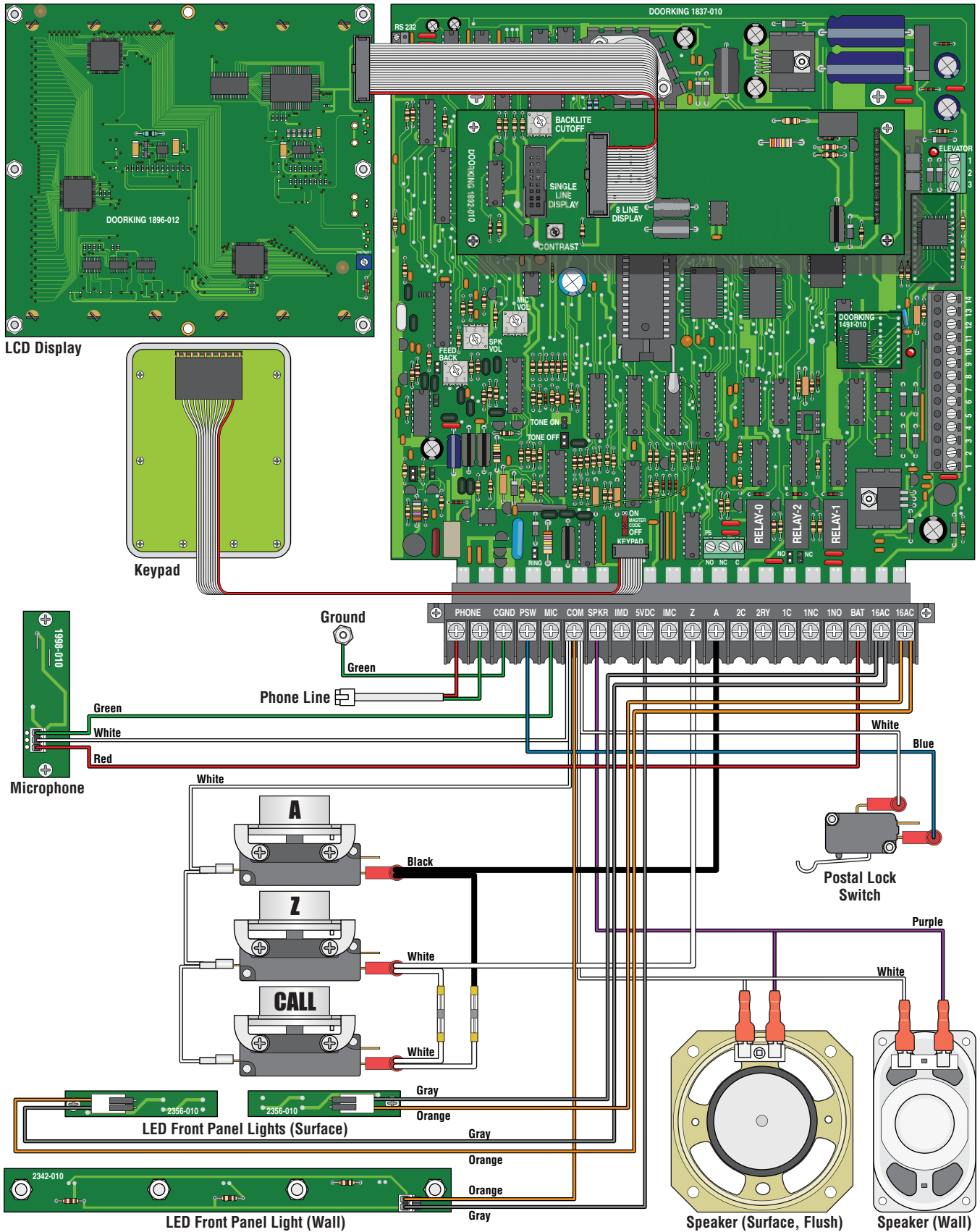

SECTION 7 - LOG TABLES

Complete the information in the tables on the following pages to maintain a record of the information that has been programmed into the telephone entry system if the system **IS NOT being programmed from a PC**. If PC programming is being utilized, there is **no reason** to maintain these log sheets since the PC will maintain a complete record of the information that has been programmed.

Make copies of the resident log sheet (page 66) so that you have enough to complete a listing of all residents and data. Enter the information as shown in the example below.

AAC stands for Alternate Area Code. Enter the alternate area code number if alternate area codes have been programmed and assigned to this resident (section 3.5.3).

DIRECTORY CODE is the resident's unique directory code. It can be 1 to 4 digits (section 3.5.1).

ENTRY CODE is the resident's four-digit entry code (section 3.7.1) if they are used.

DEVICE CODE is the resident's unique device code (section 3.6.1) if access control devices (Transmitters, cards, etc.) are used.

ELEVATOR USE ONLY (Remote Account Manager Software must be used):

SEC LEVEL (Security Level).

FL (Floor).

ER (Elevator Reference Number).

Resident Log Sheet Example

Name	AAC	PHONE NUMBER	DIRECTORY CODE	ENTRY CODE	DEVICE CODE	ELEVATOR USE		
						SEC LEVEL	FL	ER
Smith, John	3	765-0000	173	3812	04231	02	14	2

7.1 Programming Information Tables

Master Code (section 3.2.1)			
1st Digit	2nd Digit	3rd Digit	4th Digit

Relay Strike Time (section 3.3.1)		
Relay 0	Relay 1	Relay 2

Tone Open Numbers (section 3.3.3)	Relay 0	Relay 1	Relay 2
Momentary Activation			
Relay Hold OPEN			
Relay RELEASE			
Relay Hold OPEN 1 Hour			

Entry Code Ranges (section 3.7.3)	Relay 0	Relay 1	Relay 2
Low Boundary			
High Boundary			

Postal Lock Activates (section 3.3.4)		
Relay 0	Relay 1	Relay 2

Rotary "9" Activates (section 3.3.6)		
Relay 0	Relay 1	Relay 2

7.1.1 10 Area Codes

Area Code Pointers - System Set to 10 Area Codes (section 3.5.3)									
Pointer	Area Code	Pointer	Area Code	Pointer	Area Code	Pointer	Area Code	Pointer	Area Code
1		3		5		7		9	
2		4		6		8		0	

7.1.2 255 Area Codes - Page 1

Area Code Pointers - System Set to 255 Area Codes (section 3.5.3)									
Pointer	Area Code	Pointer	Area Code	Pointer	Area Code	Pointer	Area Code	Pointer	Area Code
001		027		053		079		105	
002		028		054		080		106	
003		029		055		081		107	
004		030		056		082		108	
005		031		057		083		109	
006		032		058		084		110	
007		033		059		085		111	
008		034		060		086		112	
009		035		061		087		113	
010		036		062		088		114	
011		037		063		089		115	
012		038		064		090		116	
013		039		065		091		117	
014		040		066		092		118	
015		041		067		093		119	
016		042		068		094		120	
017		043		069		095		121	
018		044		070		096		122	
019		045		071		097		123	
020		046		072		098		124	
021		047		073		099		125	
022		048		074		100		126	
023		049		075		101		127	
024		050		076		102		128	
025		051		077		103		129	
026		052		078		104		130	

7.1.2 255 Area Codes - Page 2

Area Code Pointers - System Set to 255 Area Codes (section 3.5.3)									
Pointer	Area Code	Pointer	Area Code	Pointer	Area Code	Pointer	Area Code	Pointer	Area Code
131		157		183		209		235	
132		158		184		210		236	
133		159		185		211		237	
134		160		186		212		238	
135		161		187		213		239	
136		162		188		214		240	
137		163		189		215		241	
138		164		190		216		242	
139		165		191		217		243	
140		166		192		218		244	
141		167		193		219		245	
142		168		194		220		246	
143		169		195		221		247	
144		170		196		222		248	
145		171		197		223		249	
146		172		198		224		250	
147		173		199		225		251	
148		174		200		226		252	
149		175		201		227		253	
150		176		202		228		254	
151		177		203		229		255	
152		178		204		230		000	
153		179		205		231			
154		180		206		232			
155		181		207		233			
156		182		208		234			

RESIDENT INSTRUCTIONS



Your building / community has been equipped with a **DoorKing Telephone Entry System** that will provide communication for your guest from the lobby door / gated entrance to your home by use of the local telephone network. If you have any questions regarding the use or operation of this system, please see your **System Administrator** (building manager / HOA representative) or **Call:**

_____ Phone #

Guest Communication: Your name (or apartment number) and telephone number have been programmed into the DoorKing telephone entry system under a specific **DIRECTORY CODE**. This directory code can be from 1 to 4 digits long. When a guest comes to visit you, they will look up your name in a resident directory (located on the LCD display or on a separate printed directory to provide guests with the resident directory information). Your **DIRECTORY CODE** will be shown next to your name. Your guest will enter this code on the telephone entry system keypad that will place a call to your home (If your guest already knows **YOUR** specific directory code, they can simply enter the code on the keypad without having to look up your name in the resident directory). Some telephone entry systems are equipped with a “**CALL**” button. When your name is displayed on the LCD screen in the resident directory, the guest can press the CALL button to place a call to your home. A guest **CANNOT** enter your telephone number on the keypad, it **MUST** be the **DIRECTORY CODE ONLY!**

Granting or Denying Access to your Guest: Once you have answered the phone call and you have identified your guest, you have the choice to either **grant access** or **deny access** to your guest.

Touch-Tone Phones ONLY.

To **GRANT ACCESS** to your guest, press _____ on your touch-tone telephone. The telephone entry system will respond with a confirmation tone indicating that the door or gate is opening and will automatically disconnect itself. Some newer telephones emit a very short duration tone when the number is pressed. If your telephone does this, you may have to press the “GRANT ACCESS NUMBER” twice in rapid succession to open the door or gate.

To **DENY ACCESS** to your guest, press the “#” key on your touch-tone telephone.

Rotary-Dial Phones ONLY.



To **GRANT ACCESS** to your guest, dial “9”.

To **DENY ACCESS** to your guest, **hang-up** your phone.

Call Waiting: If you are on your telephone when a guest tries to contact you from the telephone entry system, they will hear a busy signal and will have to wait for you to end your call before they can contact you. **To eliminate this problem**, you can order call waiting from your local telephone company.

Privacy: If you **DO NOT** want your name and/or apartment number listed in the electronic resident directory, inform the system administrator of this. Your telephone number can be stored in the system **without your name being displayed on the directory**. If you choose this option, you will need to inform your guest what **YOUR directory code** is, otherwise there will be **NO WAY** for them to identify **YOUR** directory code on the telephone entry system’s electronic resident directory.

Access Code: Your system may be equipped with an “**access code**” that will allow you to open the door / gate by entering this code on the telephone entry system’s keypad. Your system administrator will advise you of **YOUR** access code if this option is available.

To use your access code, **first** press the  key, and then enter your four-digit code  .

System Administrator’s Note: Fill in the phone number and access granted number above, copy and distribute this sheet to the residents.



Download **REMOTE ACCOUNT MANAGER** Software **FREE** at:
<http://www.doorking.com/telephone/telephone-accessories/software-remote-account-manager>

www.doorking.com

DoorKing, Inc.
120 S. Glasgow Avenue
Inglewood, California 90301
U.S.A.
Phone: 310-645-0023
Fax: 310-641-1586