

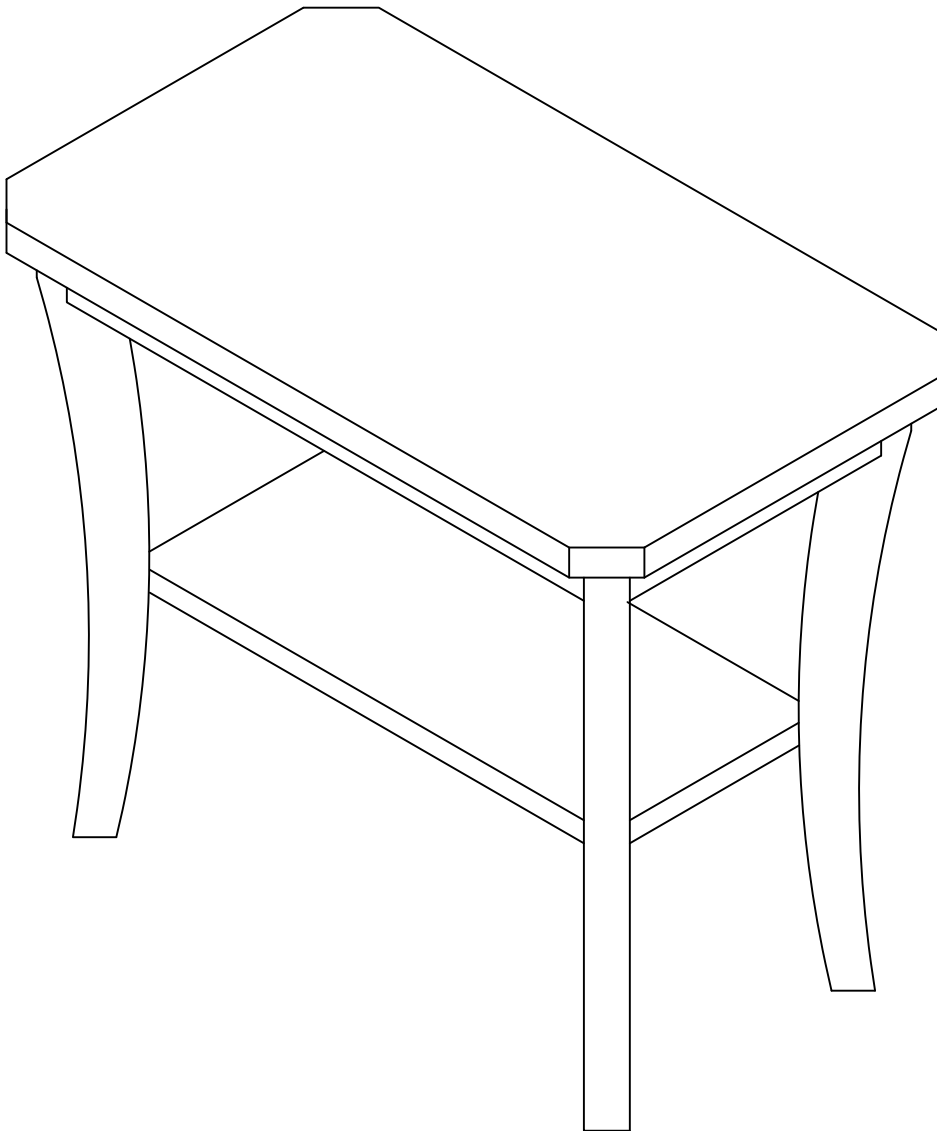









Assembly Instructions, #10305 Boa Narrow Chairside Table



A: Top Assembly	
B: (4) Legs	
C: Shelf	
D: (4) Long Bolts	
E: (12) Lock Washers	
F: (12) Flat Washers	
G: Allen Wrench	
H: (4) Short Bolts	
I : (4) Medium Bolts	
J : (4) Brackets	

Step 1

Place table top upside down on a soft surface. Fasten the legs with (4) long bolts, flat washers and lock washers using the Allen wrench. Do not tighten yet.

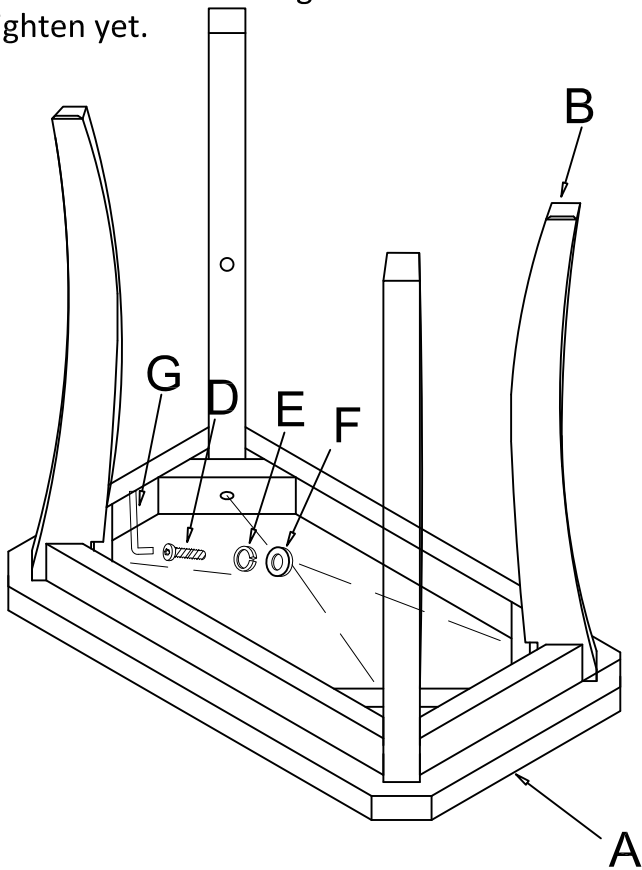

Step 2

Place the shelf upside down, tighten L brackets with (4) short bolts, flat washers and lock washers on shelf.

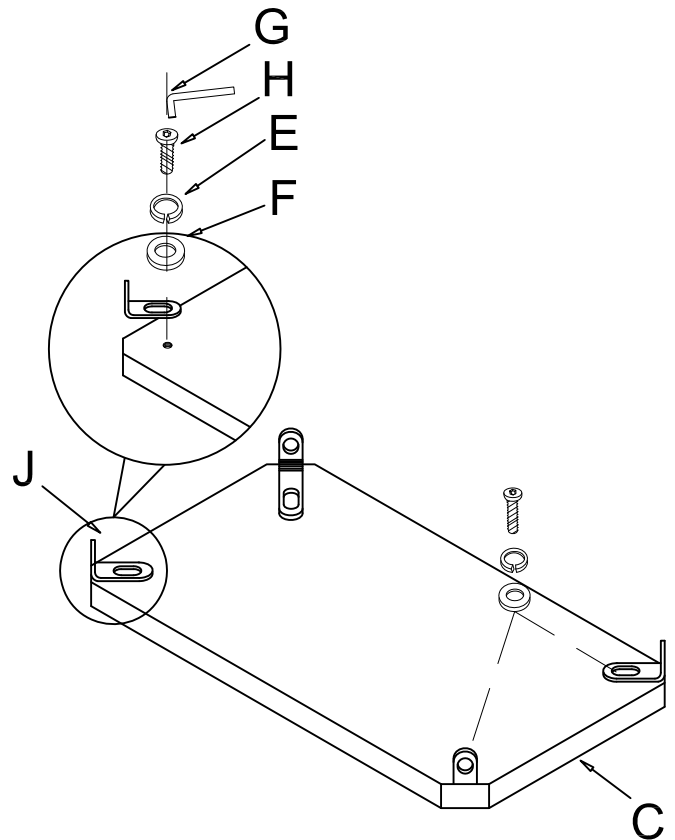

Step 3

Attach the shelf to the legs, and fasten with (4) medium bolts (I), flat washers (F) and lock washers (E) using the Allen wrench (G). Tighten all bolts.

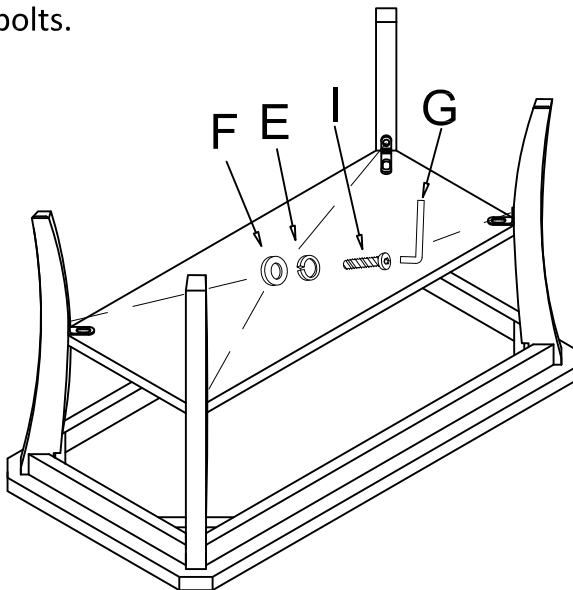

Step 4

