











Thank you for purchasing this quality product. Be sure to unpack carefully looking for small parts which may have come loose during shipment.

Read all instruction and study the drawing carefully before starting the assembly process .

HARDWARE PACK

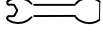
PARTS LIST

NO.	DRAWING	DESCRIPTION	SIZE	Q'TY	NO.	DRAWING	DESCRIPTION	Q'TY
A		Allen Wrench	73*29*5mm	1PC	①		Base	2PCS
B		Bolt	Ø5/16"	12PCS	②		Stretchers	1PC
C		Lock Washer	Ø5/16"	14PCS	③		Desk Top	1PC
D		Flat Washer	Ø5/16"	14PCS				
E		Threaded rod	Ø5/16"	2PCS				
F		Spanner	14mm	1PC				
G		Nut	Ø5/16"	2PCS				
H		Anti - Tip Kit		1PC				

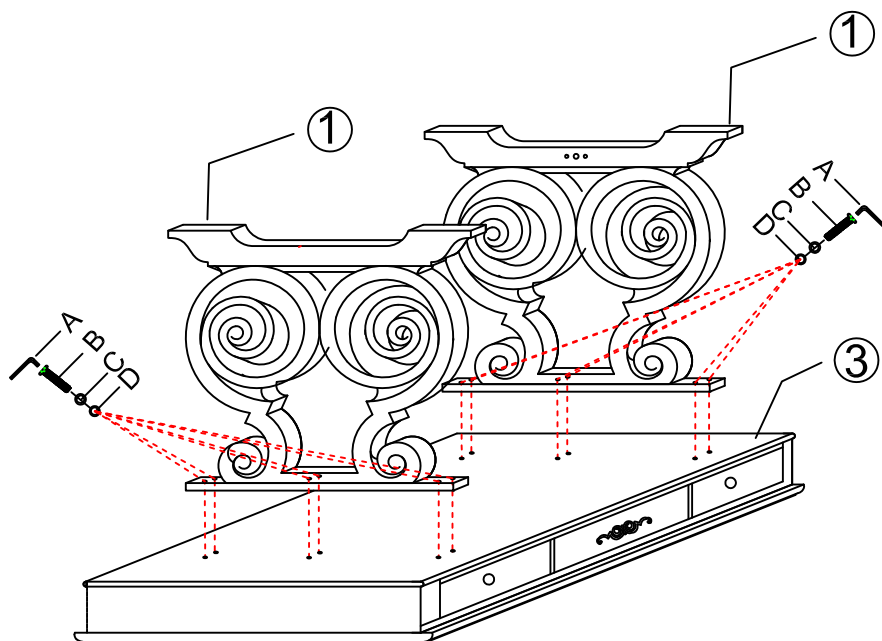

Step 1: Attach bases (1) to desk top (3) by using flat washers (D), lock washers (C) and bolts (B), turn the bolts (B) with allen wrench (A). Do not fully tighten bolts (B) at this step.

ITEM: 5878-10459-80 Writing Desk

Thank you for purchasing this quality product. Be sure to unpack carefully looking for small parts which may have come loose during shipment.

Read all instruction and study the drawing carefully before starting the assembly process .

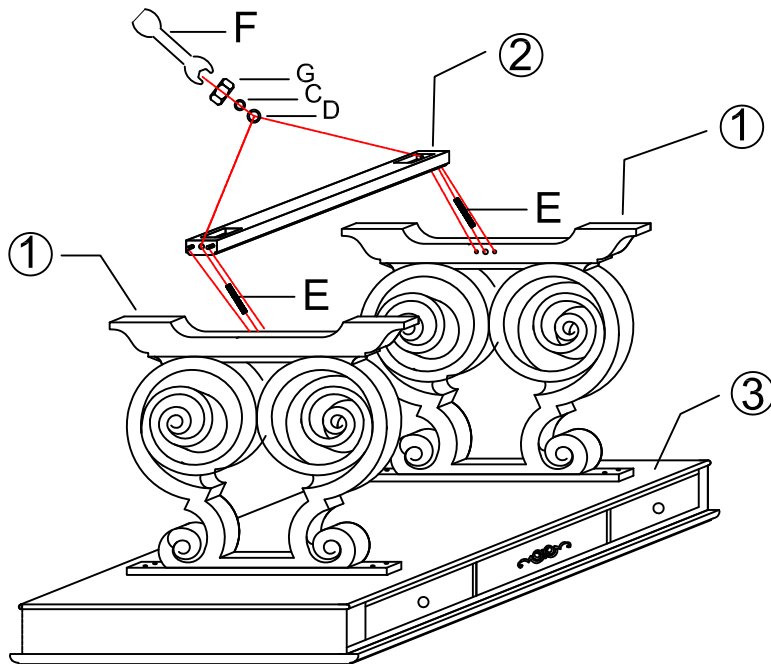

Step 2: Insert threaded rod (E) through hole on each end of stretcher (2) to the hole on each base (1), well insert flat washers (D), lock washers (C) and nuts (G) through threaded rods (E). Turn the nuts (G) with spanner (F). Do not fully tighten nuts at this step.

Step 3: Adjust bases (1) and stretcher (2) at right positions and secure bolts (B) and nuts (G).

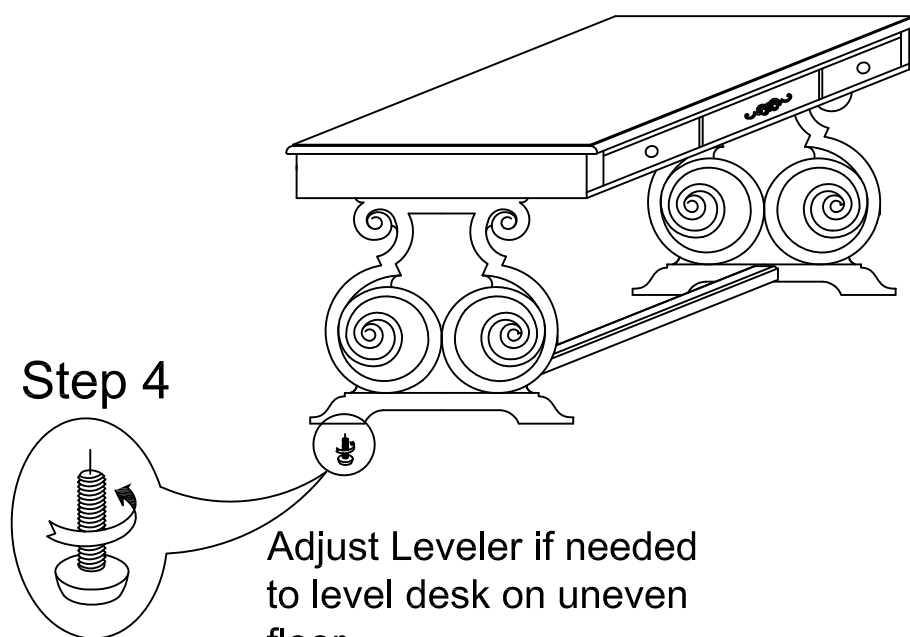

Step 4

Adjust Leveler if needed to level desk on uneven floor.