

# BERNHARDT LOFT BERNHARDT

ASSEMBLY INSTRUCTIONS FOR 203/303-224



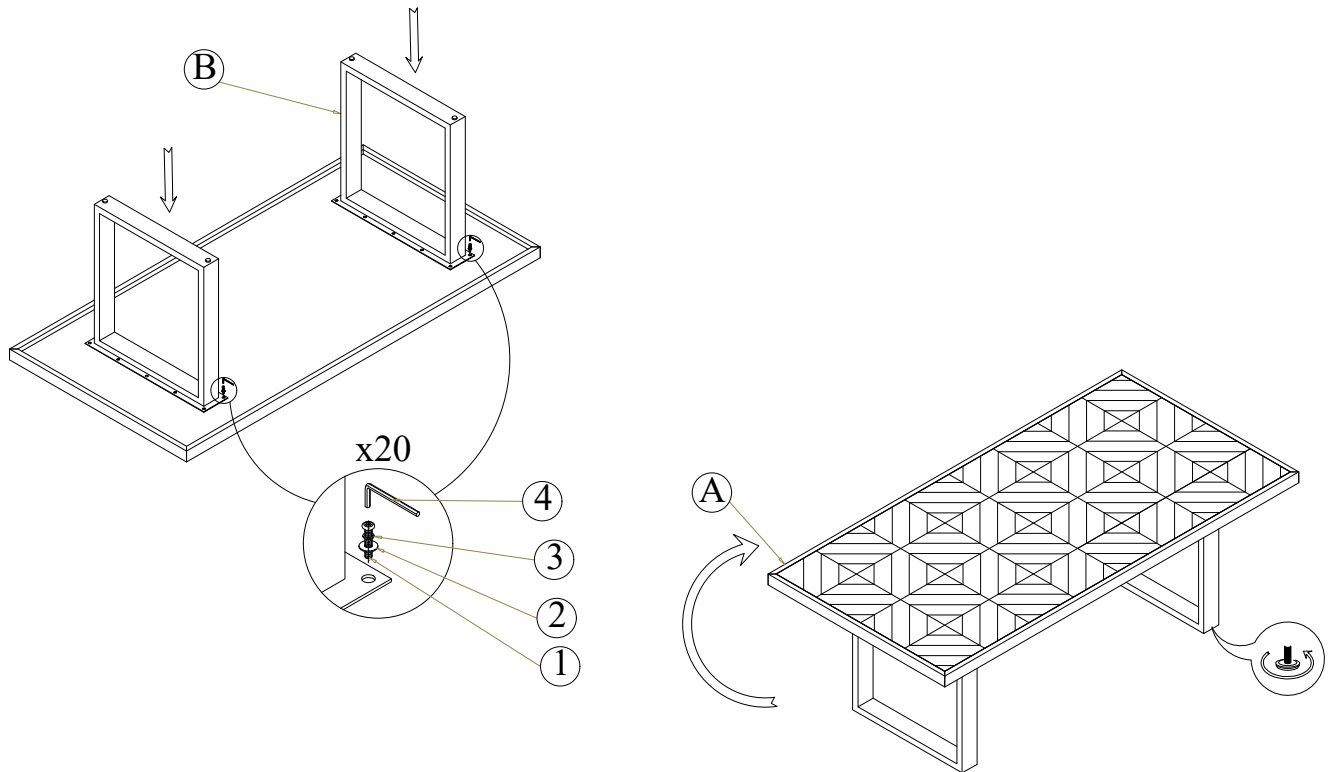

DINING TABLE

Thank you for purchasing Bernhardt Furniture. Be sure to check all packing materials carefully to ensure proper assembly.

Please read all instructions carefully before starting the assembly process. Some parts are large and heavy and require at least two people to assemble, to prevent possible injury and/or damage to the furniture.

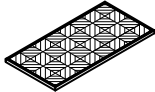

## PARTS LIST

NO.	DRAWING	DESCRIPTION	SIZE	QTY.	NO.	DRAWING	DESCRIPTION	QTY.
1		Bolts	1/4*25	20	A		Top	1
2		Flat Washer	1/4	20				
3		Lock washer	1/4	20	B		Metal Leg	2
4		Allen key	M4*60	1				

## ASSEMBLY INSTRUCTIONS.

1. Attach Metal legs (B) to underside of Top (A) using: Bolts (1), Flat Washer (2), Lock washers (3). Tighten Bolts with provided Allen key (4).
2. Set item upright and level using adjustable levelers.

## CLEANING INSTRUCTIONS

Clean surfaces with a soft damp cloth. Dry immediately