

# Installation Guide

## Bathroom Sink Faucet

K-7514, K-7515, K-7516,  
K-7517, K-7518, K-7519,  
K-13460, K-13461, K-13462,  
K-13463, K-13466, K-13467,  
K-13468, K-13469, K-13472,  
K-13473, K-13475, K-13475,  
K-45344, K-45345

**M** product numbers are for Mexico (i.e. K-12345**M**)  
Los números de productos seguidos de  
**M** corresponden a México (Ej.  
K-12345**M**)  
Français, page "Français-1"  
Español, página "Español-1"

THE BOLD LOOK  
OF **KOHLER**®

1244026-2-A

## Tools and Materials

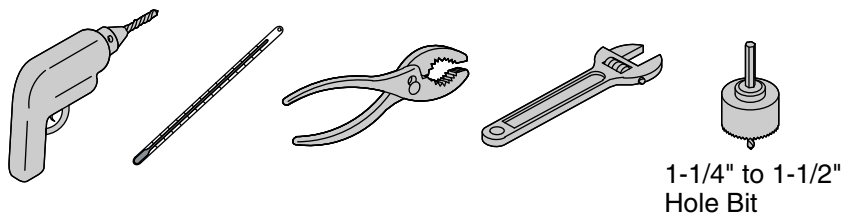

## Before You Begin

- Observe all local plumbing and building codes.
- Shut off the water supply.
- This faucet is for use on a single-hole bathroom sink.
- For new installations, install the faucet and drain to the sink before installing the sink.
- The faucet shown in this guide may differ from your actual product. The installation steps still apply.
- In order for this faucet to function properly, install the faucet so the sensor points directly toward the user.
- The faucet is rated at 3 V DC 1 W.

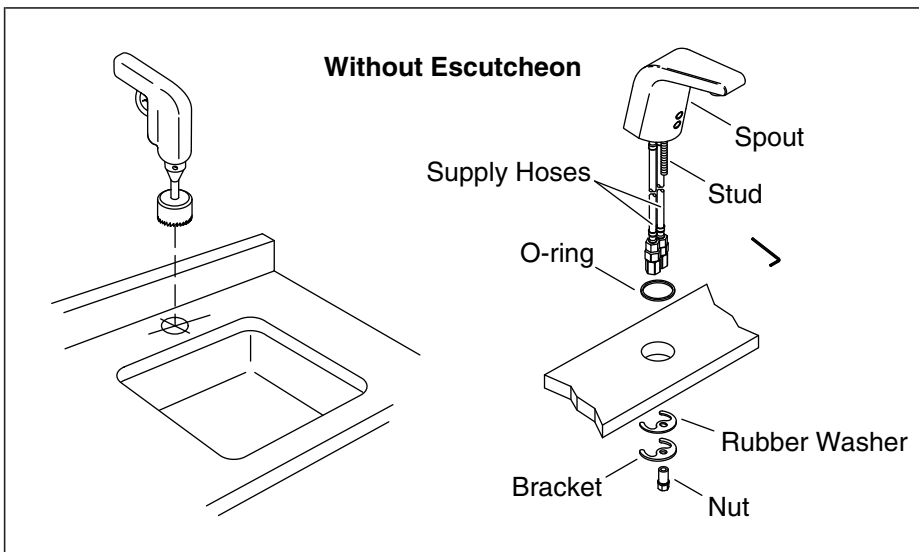

## 1. Faucet Installation

### Prepare the Site - AC and Hybrid Models

**NOTE:** Before drilling the mounting hole, use the following provisions for proper placement:

- A 1-1/4" (32 mm) minimum to 1-1/2" (38 mm) maximum diameter mounting hole is required.
- A minimum distance of 1-3/4" (44 mm) is required between the back of the spout and the wall to allow access to the screw.
- A 1-1/8" (29 mm) maximum distance is required between the sink bowl edge and the base of the spout.

### AAA Battery Operated Models Only

**NOTE:** When K-13460, K-13461, K-13466 or K-13467 are installed to drop-in sinks (sinks with the rim above the deck), the maximum height of the edge of the basin lip is 3/4" (19 mm) and the maximum distance from the edge of the sink to the front edge of the faucet is 1/2" (13 mm).

**NOTE:** When K-13472 or K-13473 are installed to drop-in sinks, the maximum height of the edge of the basin lip is 1-1/4" (32 mm).

**NOTE:** Before drilling the mounting hole, use the following provisions for proper placement:

- A 1-1/4" (32 mm) minimum to 1-1/2" (38 mm) maximum diameter mounting hole is required.

### **Faucet Installation (cont.)**

- A minimum distance of 1-3/4" (44 mm) is required between the back of the spout and the wall to allow access to the screw.

### **Install the Faucet**

- Determine the mounting hole location.
- Drill a hole through the mounting surface according to the surface manufacturer's instructions.
- Install the stud to the underside of the faucet.
- Slide the O-ring over the flexible hoses and stud, then seat the O-ring in the groove on the underside of the spout.
- Insert the spout with flexible hoses and stud through the mounting hole.
- From under the sink, slide the rubber washer and bracket onto the stud.
- Thread the nut onto the stud to secure the faucet to the mounting surface.

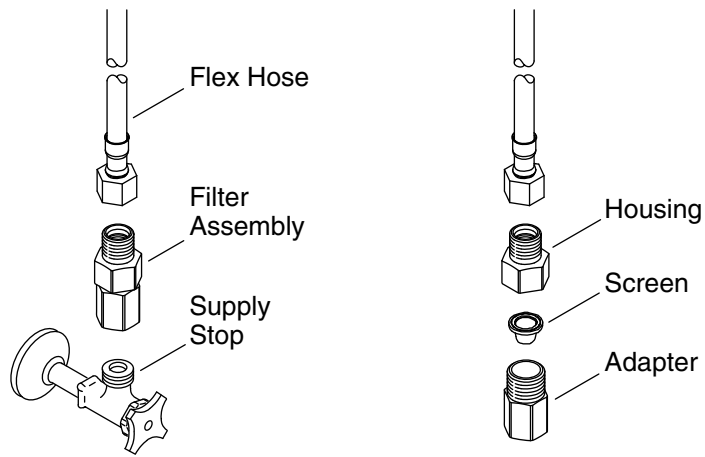

## 2. Supply Connections

### Connect the Filter Assembly

- Turn on the water and flush water through the supply stops into a bucket.
- Turn off the water.
- Remove the filter assemblies from the supply hoses. Then thread a filter assembly onto each supply stop.

### Connect the Supplies

- For models with **two hoses**, thread the left supply hose to the filter assembly on the hot supply stop and the right supply hose to the filter assembly on the cold supply stop.
- For models with **one hose**, thread the supply hose to the filter assembly on the supply stop.
- Tighten the connections with a small adjustable wrench.
- Turn on the water and flush the faucet by activating it.

**NOTE:** For optimum performance, clean your filter screens periodically. Refer to the Maintenance Guide.

### Hybrid Models

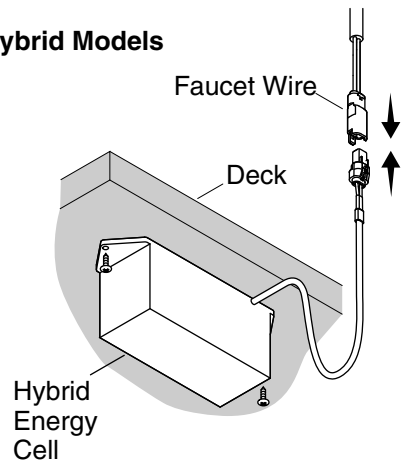

### 3. Install the Power Supply - Hybrid Models

**NOTE:** Avoid the area in front of the sensor for 2 minutes after connections are complete. The sensor will not function correctly if it is triggered in the first 2 minutes. Disconnect and reconnect the power to reset the sensor.

- Mount the Hybrid Energy Cell (HEC) under the counter using two screws (not supplied).
- Connect the HEC to the faucet wire.
- Avoid the area in front of the sensor for 2 minutes.

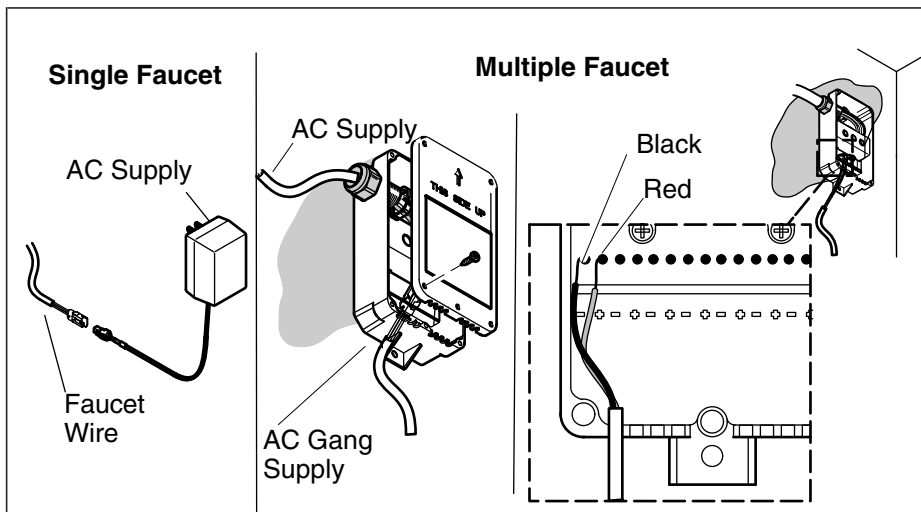

## 4. Install the AC Power Supply

### Single Faucet Installations

- Connect the faucet wire to the AC supply.
- Plug the AC supply into the wall outlet.
- Secure any excess wire under the counter.

**IMPORTANT!** The area in front of the sensor must be free of objects during the 2 minute learning cycle or the faucet may not function properly.

- Allow 2 minutes for the sensor to cycle through the automatic sensing distance.

### Multiple Faucet Installations

- Mount the AC supply under the counter using two (not supplied) screws. Orient as shown.
- Remove the cover.
- Connect the faucet wire to the faucet.
- If needed, cut and strip the AC supply wires to length.
- Connect the stripped ends to the bottom terminal block (TB2) in the supply box.

### **Install the AC Power Supply (cont.)**

**NOTE:** If a hard wired installation is required, go to the next installation section.

- Plug the AC supply into the wall outlet.
- Secure any excess wire under the counter.

**IMPORTANT!** The area in front of the sensor must be free of objects during the 2 minute learning cycle or the faucet may not function properly.

- Allow 2 minutes for the sensor to cycle through the automatic sensing distance.

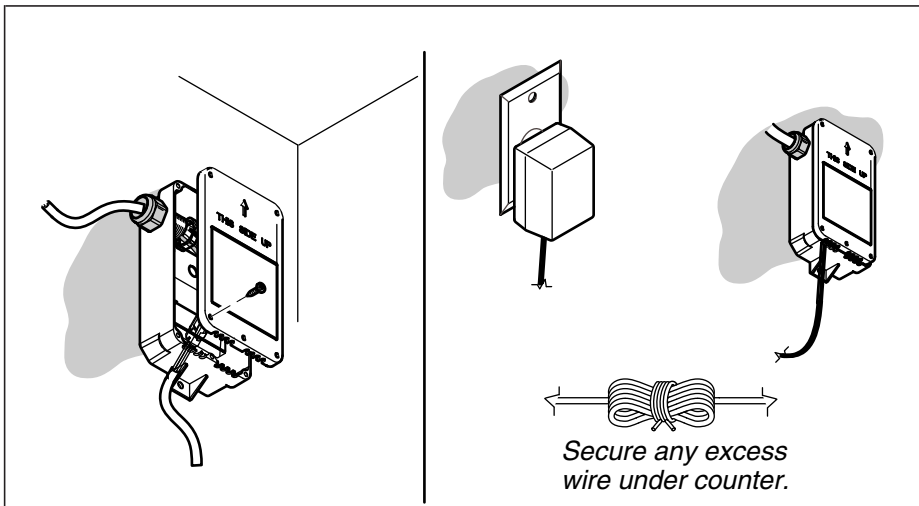

## 5. Hard Wire Installation - AC Only



**WARNING: Risk of electrical shock.** Make sure the power has been disconnected before performing the following procedures.

- Loosen the terminal block screws and remove the wires from the top terminal block.
- Loosen the outside nut of the strain relief and remove the power cord.
- Put the supply wires through the strain relief and connect to the top terminal block.

**NOTE:** If a hard wired installation is required, the strain relief may need to be replaced depending on wire used.

- Tighten the nut on the strain relief.
- Replace the cover, and install and tighten the five screws.
- Turn on the AC supply power.
- Secure any extra wire under the counter.

**IMPORTANT!** The area in front of the sensor must be free of objects during the 2 minute learning cycle or the faucet may not function properly.

- Allow 2 minutes for the sensor to cycle through the automatic sensing distance.

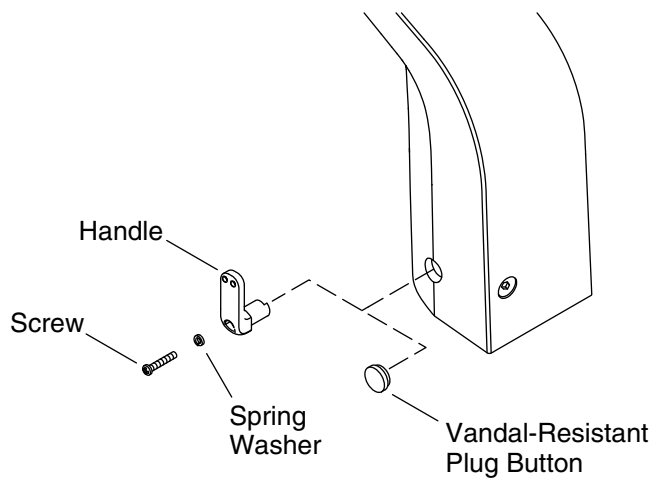

## 6. Optional Temperature Limiting Adjustment



**CAUTION: Risk of personal injury.** Scalding may result if the temperature limit is set above 120°F (49°C).

**NOTE:** The water temperature does not need to be adjusted if the water temperature is below 105°F (41°C).

**NOTE:** Use a thermometer rated for 120°F (49°C) or greater.

**NOTE:** When using a tempered water supply, install the vandal-resistant plug button.

### Adjust the Water Temperature Limit – Handle Installations

- Turn on the water and adjust to full hot by turning the handle toward the back of the faucet until it stops.
- Determine the temperature using a thermometer. If the temperature exceeds 105°F (41°C), complete the following steps.

**NOTICE:** Do not rotate the handle when removing the screw.

- Using the 2.5 mm hex wrench provided, remove and retain the handle screw.
- Remove and retain the handle with the spring washer.

### Optional Temperature Limiting Adjustment (cont.)

- Insert the handle at the desired maximum temperature. **If the handle is inserted horizontally:** This is the maximum hot temperature, where the water will be the same temperature as the water from the hot water supply. **If the handle is inserted vertically (shown):** This is the maximum cold temperature, where the water will be the same temperature as the water from the cold water supply.

**NOTICE:** Do not rotate the handle when reinstalling the screw.

- Reinstall the spring washer into the handle, then attach the handle to the faucet.
- Secure the handle to the faucet with the screw.

### Adjust the Water Temperature Limit – Vandal-Resistant Installations

**NOTE:** If you install the vandal-resistant plug button, save the handle to adjust the water temperature at a later date.

- Using the handle, adjust the water to the desired temperature.
- Using the 2.5 mm hex wrench provided, remove and retain the screw, spring washer, and handle.
- Position the vandal-resistant plug button and firmly press into place.

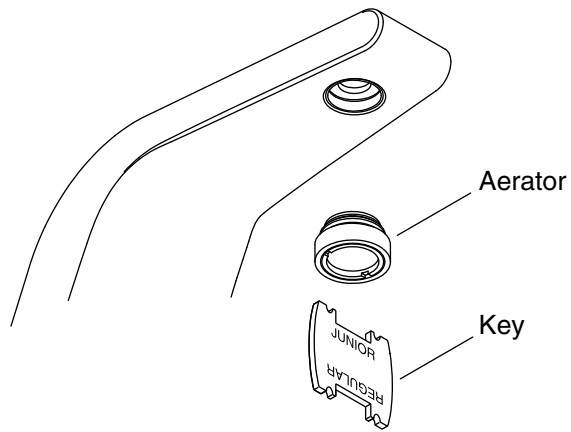

## 7. Installation Checkout

- Using the key provided, remove the aerator from the spout.
- If applicable, uncover the drain.
- Turn on the water supply and check for leaks. Adjust as needed.
- Allow the water to run through the spout for about 1 minute to remove any debris. Check for leaks and adjust as needed.
- Temporarily cover the sensors on the faucet or close the water supplies.
- Using the key provided, reinstall the aerator to the spout.
- Uncover the sensors on the faucet or turn on the water supplies.

# Maintenance Guide

## Touchless Bathroom Sink Faucet

K-13460, K-13461

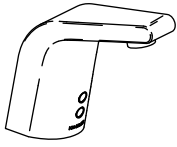

K-13466, K-13467

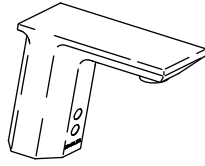

K-13472, K-13473

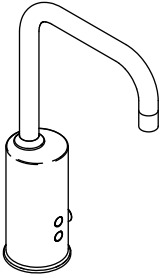

Français, page "Français-1"  
Español, pagina "Español-1"

THE BOLD LOOK  
OF **KOHLER**®

1102759-5-D



08

October 10, 2008

### EC DECLARATION OF CONFORMITY

We,  
**Kohler Company**  
444 Highland Drive, Kohler, WI 53044  
Phone 920-457-4441

declare under our sole responsibility that our products, Wallmount Touchless sensor, models:

K-13460	K-13461	K-13466	K-13467	K-13472	K-13473
K-13460W	K-13461W	K-13466W	K-13467W	K-13472W	K-13473W
K-13460IN	K-13461IN	K-13466IN	K-13467IN	K-13472IN	K-13473IN
K-13460M	K-13461M	K-13466M	K-13467M	K-13472M	K-13473M
K-13460D	K-13461D	K-13466D	K-13467D	K-13472D	K-13473D

to which this declaration relates, are in conformity with the following standards:

**Electromagnetic Compatibility Directive 89/336/EEC** of 3 May 1989 as Amended by **92/31/EEC** of 28 April 1992 and **93/68/EEC**, Article 5 of 22 July 1993, based on:

- **EN 61000-6-2: 2005**  
Electromagnetic Compatibility (EMC) – Radiated Immunity, 80MHz to 1GHz  
(Test method: IEC 61000-4-3: 2008)
- **EN 61000-6-3: 2007**  
Radiated Emission(Test Method: CISPR 16-2-3): **CLASS B**

**Low Voltage Directive 73/23/EEC** of 19 February 1973 as Amended by **93/68/EEC**, Article 13 of 22 July 1993, based on:

- **EN 60730/1:**  
"Specification for Automatic Electrical Controls for Household and Similar Use. General Requirements".
- **EN 60730/2/8:**  
"Specification for Automatic Electrical Controls for Household and Similar Use. Particular Requirements for Electrically Operated Water Valves, Including Mechanical Requirements".

Timothy J. Stessman  
Codes & Standards Dept.  
**Kohler Company**

\_\_\_\_\_  
Signature

October 10, 2008  
\_\_\_\_\_  
Date

**EC Statement**

## Care and Cleaning

For best results, keep the following in mind when caring for your KOHLER product:

- Use a mild detergent such as liquid dishwashing soap and warm water for cleaning. Do not use abrasive cleaners that may scratch or dull the surface.
- Carefully read the cleaner product label to ensure the cleaner is safe for use on the material.
- Always test your cleaning solution on an inconspicuous area before applying to the entire surface.
- Do not allow cleaners to sit or soak on the surface.
- Wipe surfaces clean and rinse completely with water immediately after cleaner application. Rinse and dry any overspray that lands on nearby surfaces.
- Use a soft, dampened sponge or cloth. Never use an abrasive material such as a brush or scouring pad to clean surfaces.

For detailed cleaning information and products to consider, visit [www.kohler.com/clean](http://www.kohler.com/clean). To order Care & Cleaning information, call 1-800-456-4537.

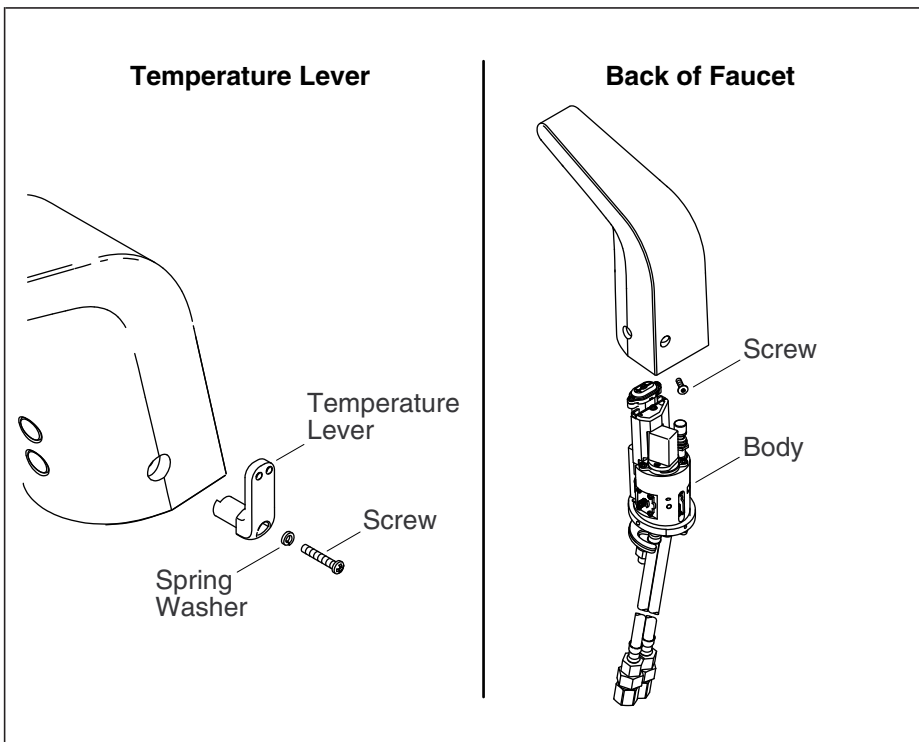

### Disassemble/Reassemble the Faucet

**NOTE:** Cover the drain with the plastic cap (provided) or towel to avoid losing small parts during this procedure.

#### Disassemble

- For K-13460, K-13466, and K-13472 only, use the 2.5 mm hex wrench provided to remove and retain the screw from the temperature lever. Remove and retain the temperature lever with the spring washer.
- Remove and retain the screw from the back of the faucet.

**IMPORTANT!** Take care to avoid scratching the sensor lens when removing the spout.

- Slide the spout forward and off the body.

#### Reassemble

- Slide the spout over the body until the base of the spout is flush against the mounting surface.
- Reinstall the screw into the back of the faucet.

**Disassemble/Reassemble the Faucet (cont.)**

- Reinsert the temperature lever with spring washer into the faucet.
- Reinstall the screw to secure the temperature lever to the faucet.

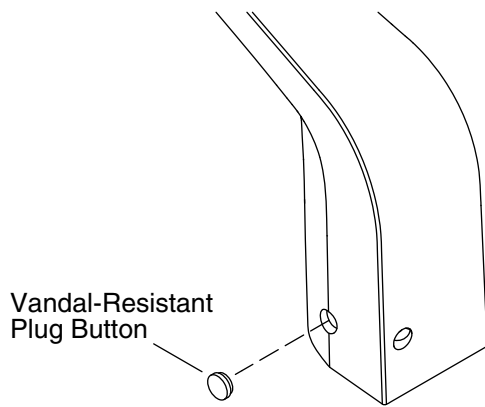

### Remove the Vandal-Resistant Plug

**NOTE:** Disassemble the faucet following the steps in the "Disassemble/Reassemble the Faucet" section.

- From inside the faucet body, use a screwdriver to pop out the vandal-resistant plug button.
- If you are adjusting the temperature, go to the "Optional Temperature Limiting Adjustment" section and follow the instructions.
- If you are installing the handle assembly, refer to the illustration in the "Optional Temperature Limiting Adjustment" section. Otherwise, reinstall the plug button.
- Position the plug button and firmly press into place.

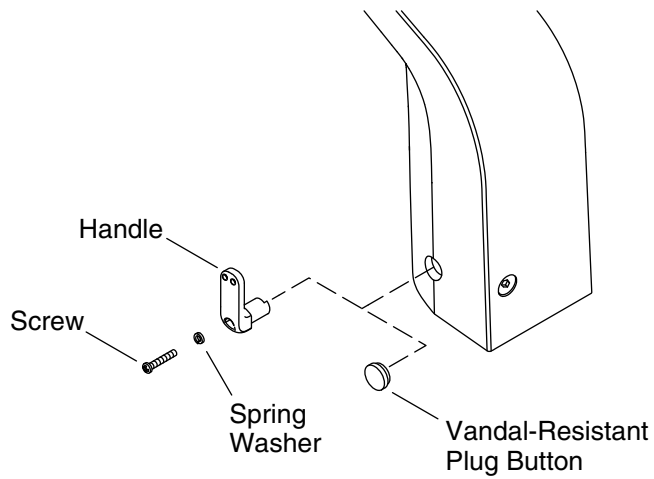

### Optional Temperature Limiting Adjustment



**CAUTION: Risk of personal injury.** Scalding may result if the temperature limit is not properly set.

**NOTE:** The water temperature does not need to be adjusted if the water temperature is below 105°F (41°C).

**NOTE:** Use a thermometer rated for 120°F (49°C) or greater.

**NOTE:** When using a tempered water supply, install the vandal-resistant plug button.

#### Adjust the Water Temperature Limit – Handle Installations

- Turn on the water and adjust to full hot by turning the handle toward the back of the faucet until it stops.
- Determine the temperature using a thermometer. If the temperature exceeds 105°F (41°C), complete the following steps.

**NOTICE:** Do not rotate the handle when removing the screw.

- Using the 2.5 mm hex wrench provided, remove and retain the handle screw.
- Remove and retain the handle with the spring washer.

### Optional Temperature Limiting Adjustment (cont.)

- Insert the handle at the desired maximum temperature. **If the handle is inserted horizontally:** This is the maximum hot temperature, where the water will be the same temperature as the water from the hot water supply. **If the handle is inserted vertically (shown):** This is the maximum cold temperature, where the water will be the same temperature as the water from the cold water supply.

**NOTICE:** Do not rotate the handle when reinstalling the screw.

- Reinstall the spring washer into the handle, then attach the handle to the faucet.
- Secure the handle to the faucet with the screw.

### Adjust the Water Temperature Limit – Vandal-Resistant Installations

**NOTE:** If you install the vandal-resistant plug button, save the handle to adjust the water temperature at a later date.

- Using the handle, adjust the water to the desired temperature.
- Using the 2.5 mm hex wrench provided, remove and retain the screw, spring washer, and handle.
- Position the vandal-resistant plug button and firmly press into place.

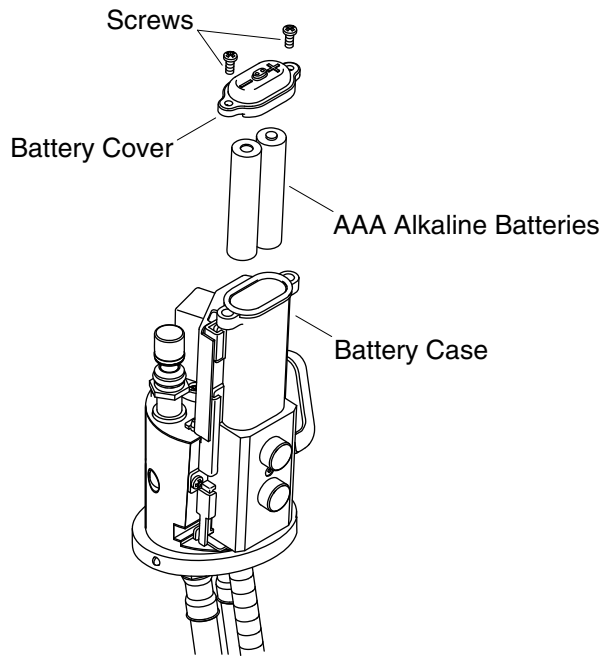

### Service the Battery

- Disassemble the faucet to access the battery case. Refer to the "Disassemble/Reassemble the Faucet" section.
- Using a small torx screwdriver, remove and retain the two screws from the battery case.
- Insert two AAA Alkaline batteries (not provided) into the battery case.
- Reinstall the two screws into the battery case.
- Reassemble the faucet.
- Wait approximately two minutes to allow the faucet to cycle through the automatic sensing distance before use.

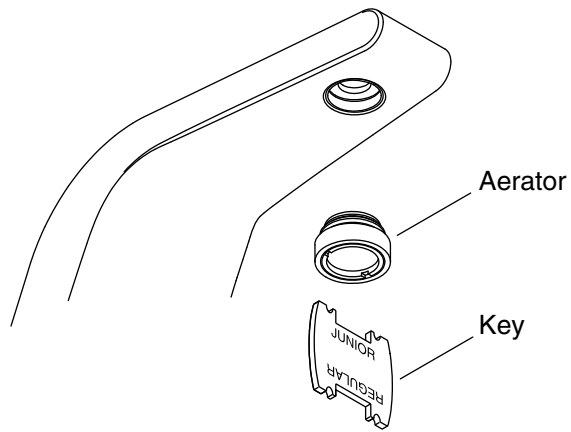

## Aerator

- Using the key provided, remove the aerator from the spout.
- If applicable, uncover the drain.
- Turn on the main water supply and check for leaks.
- Allow the water to run through the spout for about one minute to remove any debris. Check for leaks and adjust as needed.
- Temporarily cover the sensors on the faucet or close the water supplies.
- Using the key provided, reinstall the aerator to the spout.
- Uncover the sensors on the faucet or turn on the water supplies.

## Warranty

### **KOHLER® Electronic Faucets, Valves and Controls FIVE-YEAR LIMITED WARRANTY**

Kohler Co. warrants that its electronic faucets, valves and controls will be free of defects in material and workmanship during normal residential use for five years from the date the product is installed. This warranty applies only to electronic faucets, valves and controls installed in the United States of America, Canada and Mexico ("North America").

If a defect is found in normal residential use, Kohler Co. will, at its election, repair, provide a replacement part or product, or make appropriate adjustment where Kohler Co.'s inspection discloses any