

5-6 INCH LED RECESSED DOWNLIGHT 5 WHITE COLOR TEMPERATURE SELECT

IMPORTANT SAFETY INSTRUCTIONS AND INSTALLATION GUIDE

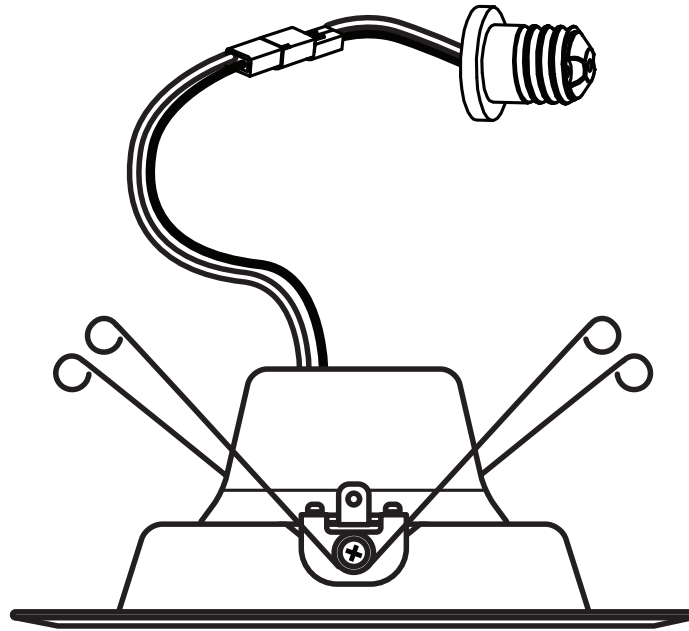

IMPORTANT, RETAIN FOR FUTURE REFERENCE:
READ CAREFULLY



Table of Contents

Safety Information	2
FCC Statement	2
Warranty	2
Pre-Assembly	3
Housing Dimensions and Lighting Distribution	3
Choose A White Color Setting	3
Adjust Torsion Springs for 5 or 6 Inch Recessed Housing	3
Installation with Socket Adapter	4
Installation without Socket Adapter	4

Safety Information

For your safety:

- Do not make or alter any open holes in an enclosure of wiring or electrical components during product installation.
- THE RETROFIT KIT IS ACCEPTED AS A COMPONENT OF A LUMINAIRE WHERE THE SUITABILITY OF THE COMBINATION SHALL BE DETERMINED BY CSA OR AUTHORITIES HAVING JURISDICTION.**
- THIS DEVICE IS NOT INTENDED FOR USE WITH EMERGENCY EXITS.**
- DANGER - RISK OF SHOCK: DISCONNECT POWER BEFORE INSTALLATION.**
- CAN BE USED IN SHALLOW HOUSINGS.**
- This fixture is designed for use in a circuit protected by a fuse or circuit breaker.**
- Account for small parts and discard packing material, as these may be hazardous to children.**
- **Suitable for Type IC Housings**
- **Suitable for Type Non-IC Housings**

Product Specifications

- 120VAC, 60Hz, 10.2 Watts
- Dim mable
- Suitable for Wet Location



WARNING: RISK OF FIRE OR ELECTRIC SHOCK. LED Retrofit Kit installation requires knowledge of luminaires electrical systems. If not qualified, do not attempt installation. Contact a qualified electrician.



WARNING: RISK OF FIRE OR ELECTRIC SHOCK: Install this product only in luminaires that have the construction features and dimensions shown in this manual.



WARNING: To prevent wiring damage or abrasion, do not expose wiring to edges of sheet metal or other sharp objects.



CAUTION: To avoid possible electrical shock, be sure that power supply is turned off at fuse box or circuit breaker before installing or servicing fixture.
LED recessed downlights conversion: for use only with products described and installed in accordance with the instructions provided with this recessed downlight.

FCC STATEMENT

Supplier's Declaration of Conformity:

47 CFR § 2.1077 Compliance Information

Responsible Party: Feit Electric Company

4901 Gregg Road, Pico Rivera, CA 90660, USA

Unique Identifier: LEDR56B/6WYCA

This device complies with part 15 of the FCC Rules. Operation is subject to the following two conditions: (1) This device may not cause harmful interference, and (2) this device must accept any interference received, including interference that may cause undesired operation. Note: This equipment has been tested and found to comply with the limits for a Class B digital device, pursuant to part 15 of the FCC Rules. These limits are designed to provide reasonable protection against harmful interference in a residential installation. This equipment generates, uses and can radiate radio frequency energy and, if not installed and used in accordance with the instructions, may cause harmful interference to radio communications. However, there is no guarantee that interference will not occur in a particular installation. If this equipment does cause harmful interference to radio or television reception, which can be determined by turning the equipment off and on, the user is encouraged to try to correct the interference by one or more of the following measures: Reorient or relocate the receiving antenna. Increase the separation between the equipment and receiver. Connect the equipment into an outlet on a circuit different from that to which the receiver is connected. Consult the dealer or an experienced radio/TV technician for help. Any changes or modifications not expressly approved by the manufacturer could void the user's authority to operate the equipment.

GENERAL: All electrical connections must be in accordance with local and National Electrical Code (N.E.C.) standards. If you are unfamiliar with proper electrical wiring connections obtain the services of a certified electrician.

Remove the fixture and the mounting package from the box and make sure that no parts are missing by referencing the illustrations on the installation instructions.

Limited Warranty

This product is warranted to be free from defects in workmanship and materials for up to 5 years from date of purchase. If the product fails within the warranty period, please contact Feit Electric at info@feit.com or visit feit.com/contact-us for instructions on replacement or refund. REPLACEMENT OR REFUND IS YOUR SOLE REMEDY. EXCEPT TO THE EXTENT PROHIBITED BY APPLICABLE LAW, ANY IMPLIED WARRANTIES ARE LIMITED IN DURATION TO THE DURATION OF THIS WARRANTY. LIABILITY FOR INCIDENTAL OR CONSEQUENTIAL DAMAGES IS HEREBY EXPRESSLY EXCLUDED. Some states and provinces do not allow the exclusion of incidental or consequential damages, so the above limitation or exclusion may not apply to you. This warranty gives you specific legal rights, and you may also have other rights which vary from state to state or province to province.

Pre-Assembly

TOOLS REQUIRED (NOT INCLUDED)

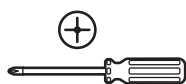

Phillips Screwdriver

INCLUDED IN BOX

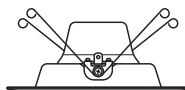

(1) Recessed Downlight Trim



(1) Medium Base (E26) Socket Adapter

Housing Dimensions and Lighting Distribution

MINIMUM RECESSED HOUSING DIMENSIONS:

When using 5 inch recessed luminaire:

5.11 inch (130mm) DIA X 7.48 inch (190mm) HEIGHT

When using 6 inch recessed luminaire:

6.06 inch (154mm) DIA X 7.40 inch (188mm) HEIGHT

Distance	Center Beam (Foot Candles)	Beam Diameter
3 ft.	41	8.6 ft.
5 ft.	15	14 ft.
8 ft.	5.8	23 ft.
15 ft.	1.7	43 ft.
Beam Angle = 110°		Candela (CD) @ Center Beam (CB) : 372

Choose A White Color Setting

Change the mood anytime.

Select SWITCH on the fixture before installation, then use your existing wall switch to toggle through the different shades of white.

Soft White	2700K
Bright White	3000K
Neutral White	3500K
Cool White	4000K
Daylight	5000K
Wall Switch	

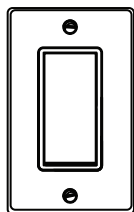
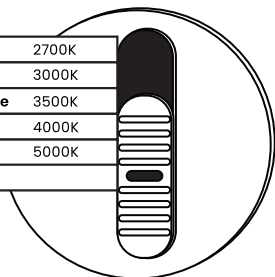

OR

Choose your favorite light.

Set your preferred shade of white from an integrated switch on the fixtures before installation.

Soft White	2700K
Bright White	3000K
Neutral White	3500K
Cool White	4000K
Daylight	5000K
Wall Switch	

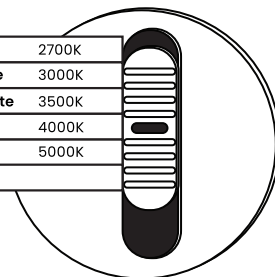

Adjust Torsion Spring Holder for 5 or 6 Inch Recessed Housing

For 5 inch recessed housings

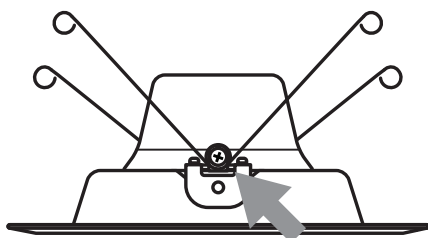

Adjust torsion spring holder

Front View

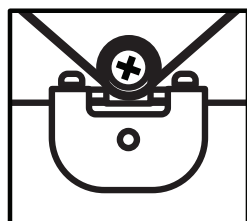

Side View

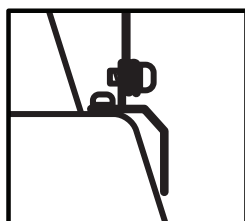

Default setting for 6 inch recessed housings

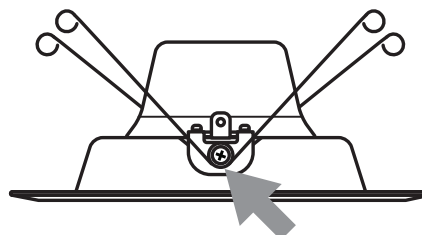

Front View

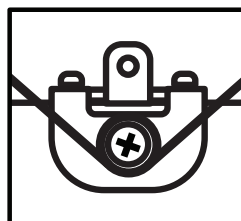

Side View

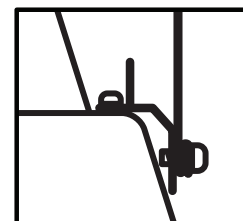

Installation with socket adapter

1. Turn Off the power at the switch and fuse or circuit breaker box.
2. Remove existing trim if present in the recessing housing.
3. Check to make sure the recessed housing has torsion spring brackets.

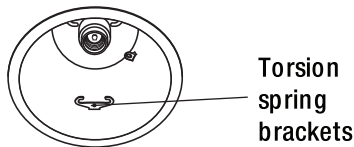

4. The recessed downlight trim is ready to use in a 6 inch recessed housing. If using a 5 inch recessed housing, loosen the torsion spring screws and move them from the 6 inch position to the 5 inch position. Retighten the screws to secure the torsion springs in place.

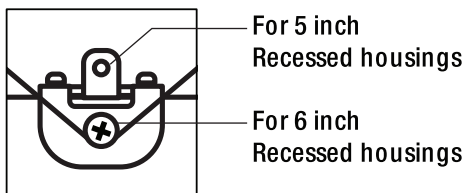

5. Install the medium base (E26) socket adapter into socket.

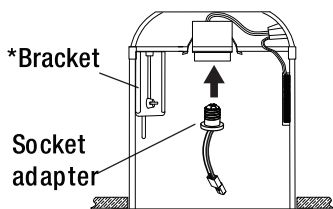

***NOTE:** Attach the provided silver label where visible on the luminaire if the bracket needs to be removed.

6. Connect the orange connectors (terminals).

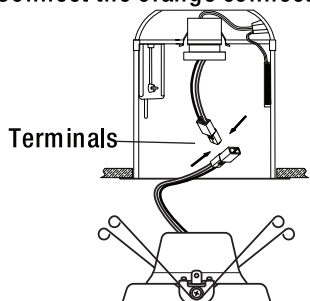

***NOTE:** Select your preferred white color by moving the switch on the back of the trim prior to connection.

7. Squeeze each torsion spring together and insert them into the torque spring brackets.

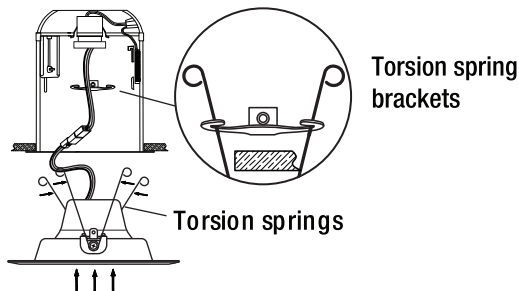

8. Release the torsion springs and gently push up on the trim so that the torsion springs expand and lift the trim into place.

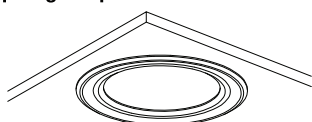

Installation without socket adapter only if existing recessed fixture has orange connectors

1. Turn Off the power at the switch and fuse or circuit breaker box.
2. Remove existing trim if present in the recessing housing.
3. Check to make sure the recessed housing has torsion spring brackets.

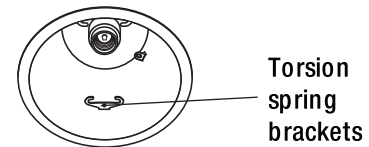

4. Do not use the medium base (E26) socket adapter in this installation.

5. The recessed downlight trim is ready to use in a 6 inch recessed housing. If using a 5 inch recessed housing, loosen the torsion spring screws and move them from the 6 inch position to the 5 inch position. Retighten the screws to secure the torsion springs in place.

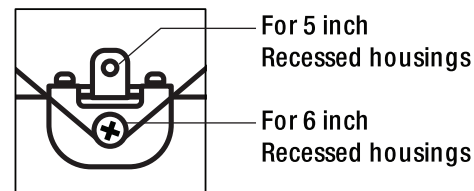

6. Connect the orange connectors (terminals) to each other. (your existing luminaire must contain orange connectors)

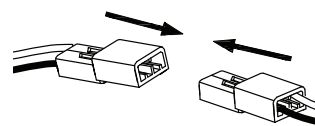

***NOTE:** Select your preferred white color by moving the switch on the back of the trim prior to connection.

7. Squeeze each torsion spring together and insert them into the torque spring brackets.

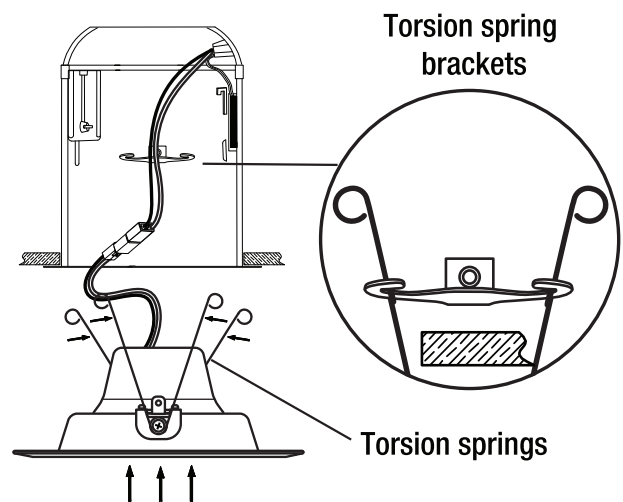

8. Release the torsion springs and gently push up on the trim so that the torsion springs expand and lift the trim into place.

