

SIDES

BOTTOM

UL File #

E22445

Material: Aluminum Powder Coating Silver Grey

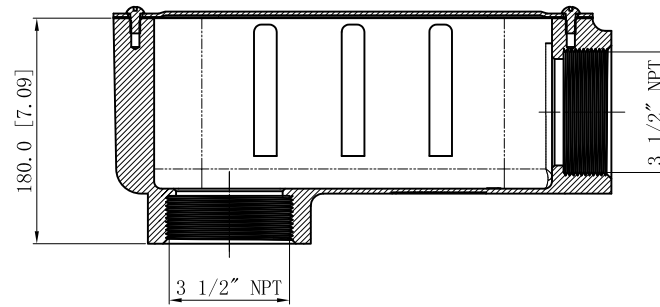
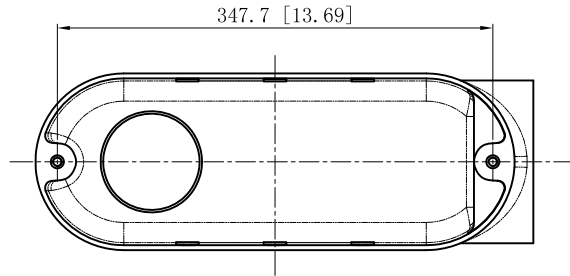

CUTAWAY VIEW A-A

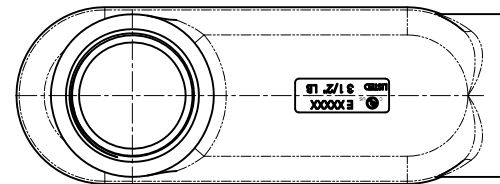
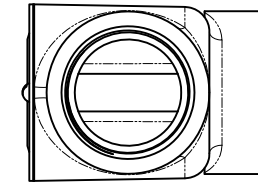
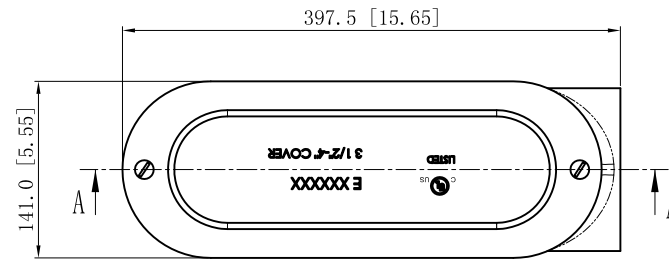
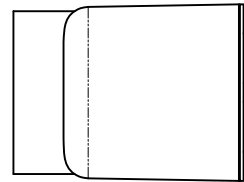
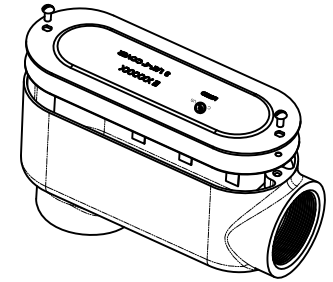

This data sheet is for reference only .GARVIN INDUSTRIES reserves the right to make changes to the design without prior notice.

DESCRIPTION

TRADE REFERENCE TERMS

STANDARD PACKING

1 PCS

GARVIN INDUSTRIES

"LB" ALUMINUM CONDUIT BODY

TITLE

SIZE A4

DWG NO.

LB350

REV

DATA SHEET