

SIDES	BOTTOM
Material: Steel-#3 ZAMAK Zinc Plated	

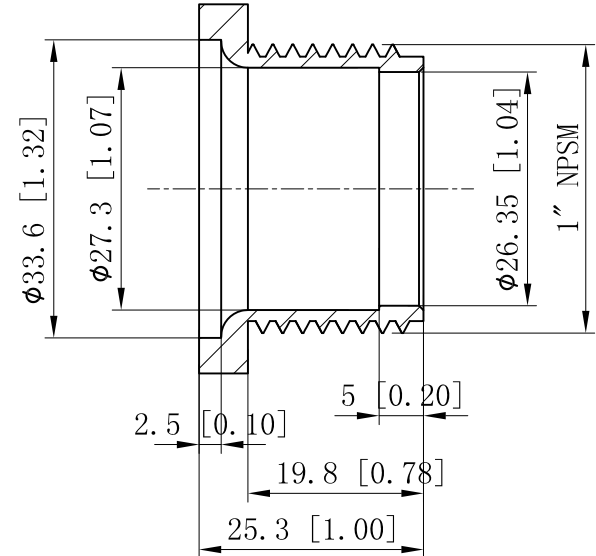

CUTAWAY VIEW A-A

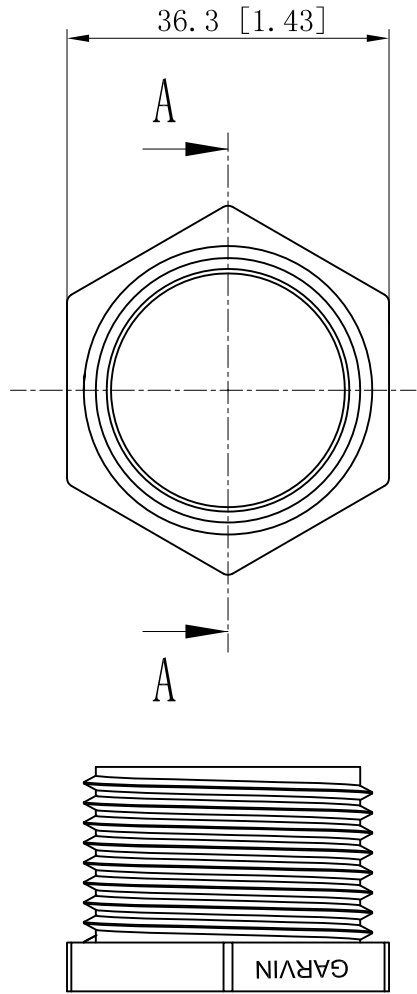
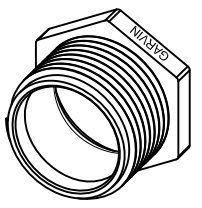

This data sheet is for reference only .GARVIN INDUSTRIES reserves the right to make changes to the design without prior notice.

DESCRIPTION
TRADE REFERENCE TERMS

STANDARD PACKING	<h1 style="text-align: center;">GARVIN INDUSTRIES</h1>		
250 PCS			
	SIZE	DWG NO.	REV
	A4	CHN-100100	
	DATA SHEET		
	www.garvinindustries.com		