

SIDES	BOTTOM
Material: Steel-0.0197"-G60 Galvanized	

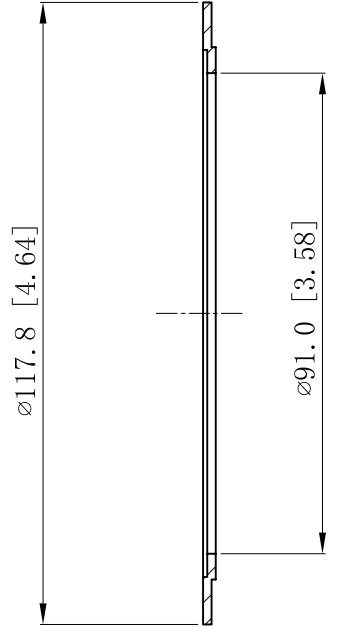

CUTAWAY VIEW A-A

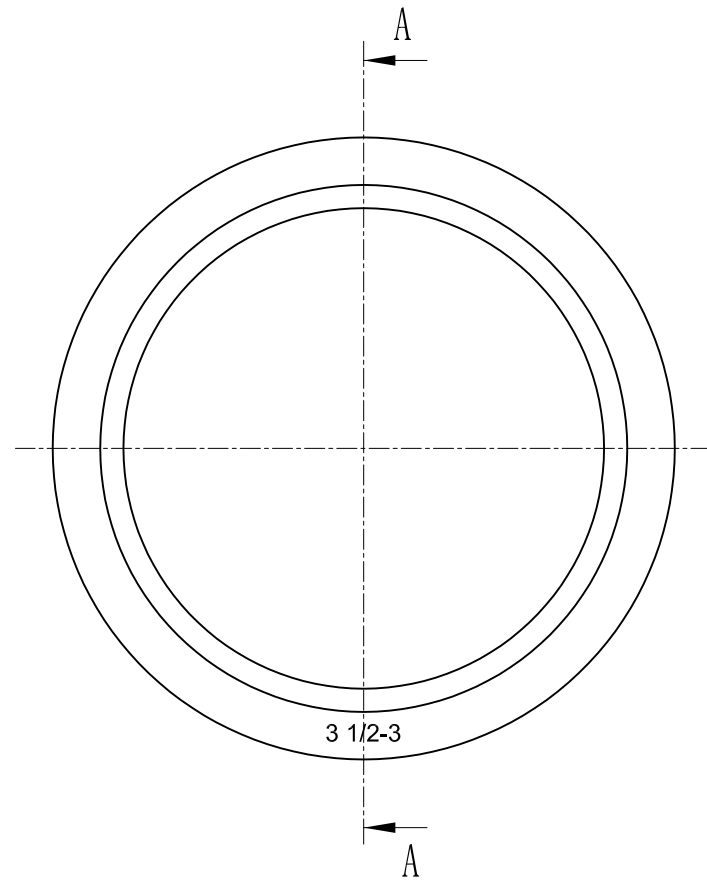

This data sheet is for reference only .GARVIN INDUSTRIES reserves the right to make changes to the design without prior notice.

DESCRIPTION
TRADE REFERENCE TERMS

STANDARD PACKING
25 PCS

GARVIN INDUSTRIES		
TITLE REDUCING WASHER		
SIZE A4	DWG NO. RW-350300	REV A
DATA SHEET		