

ASSEMBLY AND INSTALLATION INSTRUCTIONS

W0486

WARNING: TO AVOID RISK OF ELECTRICAL SHOCK, BE SURE TO SHUT OFF POWER BEFORE INSTALLING OR SERVICING THIS FIXTURE.

NOTES: 1. Before installing, consult local electrical codes for wiring and grounding requirements.
2. Read and save these instructions.

Hardware Package (included):

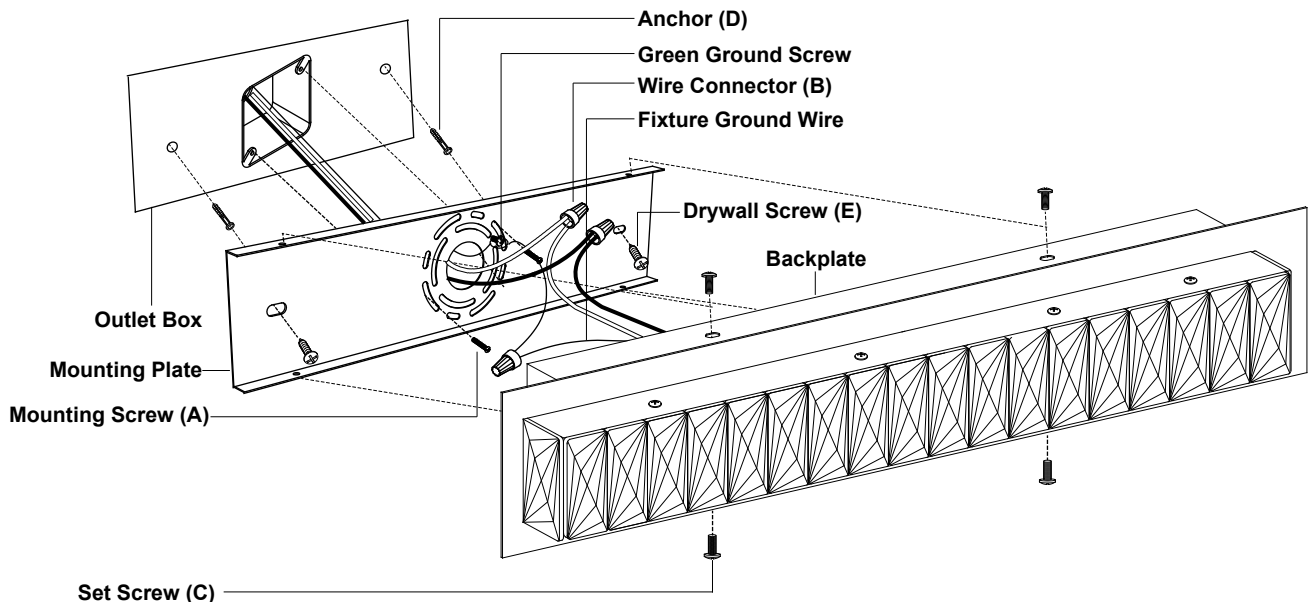
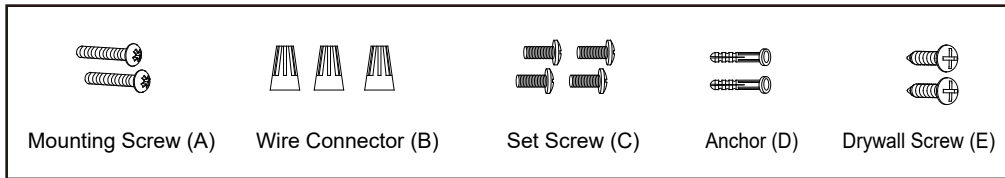

Installation Steps

Turn off the power at fuse or circuit box.

1. Unscrew the four set screws (C). Remove the mounting plate from the backplate.
2. Fix the mounting plate to the wall.
 - 2a. For cement and drywall material:
Hold the mounting plate to the outlet box and mark the outermost set holes on the wall surface for drilling. Remove the mounting plate from the outlet box. Drill two holes. Thread the anchors (D) into the holes, and then attach the mounting plate to the outlet box by using two mounting screws (A). Secure the drywall screws (E) through the set holes into the anchors (D).
 - 2b. For wooden material:
Attach the mounting plate to the outlet box by using two mounting screws (A), and then secure the drywall screws (E) through the set holes to the wall.





3. Pull out the source wires from the outlet box. Make wire connections using wire connectors (B) as follows:
 - Connect the black (hot) wire from the fixture to the black (hot) wire from the power source.
 - Connect the white (neutral) wire from the fixture to the white (neutral) wire from the power source.
 - Attach the fixture ground wire (bare wire) to the mounting plate with the green ground screw, then connect the fixture ground wire to the house ground wire with a wire connector (B).
 Carefully put the wires back into the outlet box.
4. Attach the backplate of the fixture to the mounting plate by aligning the holes on the mounting plate and backplate, then secure the backplate with the four set screws (C).

Turn on the power at fuse or circuit box.

Note: Dimming range: 100% full illumination to 10% of full illumination.
 This fixture is dimmable with a forward phase electronic dimmer. Dimmers tested to be compatible with this fixture are the Lutron: TGCL-153PH, MACL-153MH, SCL-153P, DVWCL-153PH.
 If you are unfamiliar with electrical installations, it is recommended you have a qualified electrician for your installations.

The following parts are available for reorder if damaged or missing.

Spare Parts List:

					Assembly Kit 6858MM (1 SET)
Mounting Screw (A)	Wire Connector (B)	Set Screw (C)	Anchor (D)	Drywall Screw (E)	

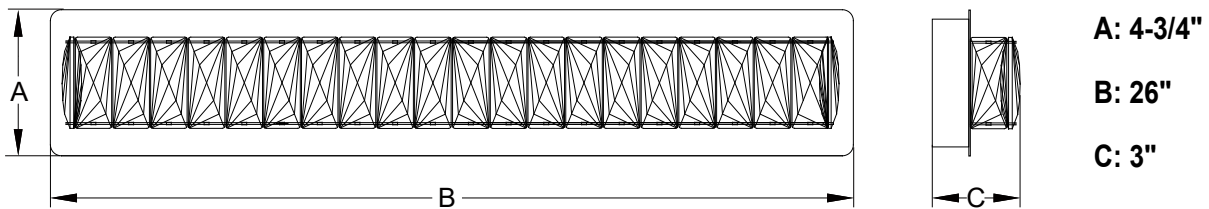

5 Year Limited Warranty

Vaxcel warrants all of our products against defects in workmanship and finishes for one year following the date of shipment.

In addition:

- Any product with an integrated motion sensor or dusk-to-dawn photocell is supported by a 5-year warranty for the functionality of the product.
- Any product with integrated LED modules is covered by a 5-year warranty on the LED functionality.

Exclusions: This warranty does not include the failure of products from extreme acts of nature; environmental conditions not suited for the products intended use; operation in temperatures outside of the range specified in the instruction manual; usage with improper power supply, power surges or dips. For coastal locations, some corrosion is considered normal for the environment.

Vaxcel reserves the right to repair, replace or issue a credit for any properly installed product, provided it is returned per RMA instruction. This warranty is limited to the cost of the product only and does not extend to transportation, installation or replacement costs.

How can warranty service be obtained?
 info@vaxcel.com
 1-800-482-9235