

VERSANORA

Minimalista Glass Dining Table

VNF-00026

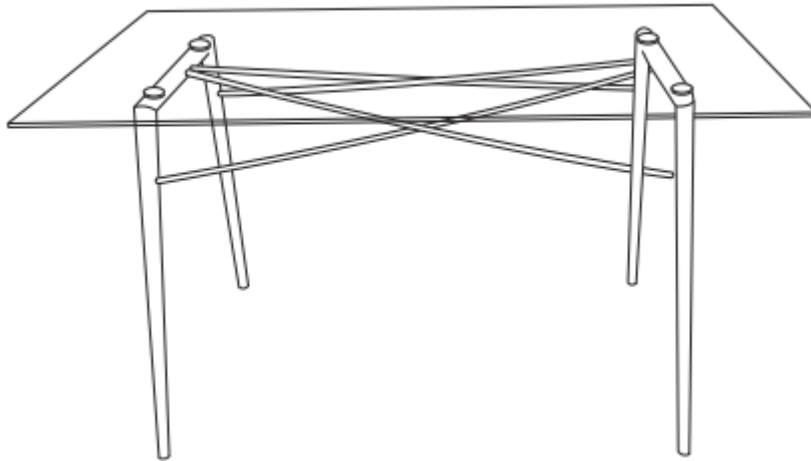

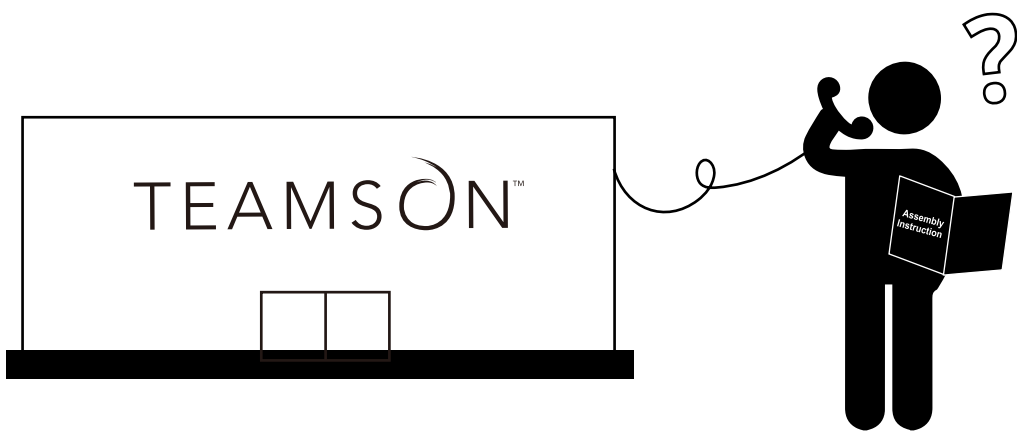
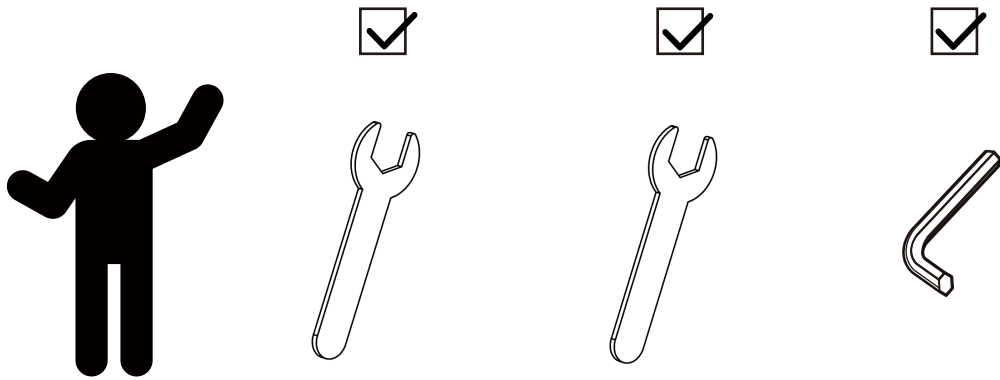

** Got questions? Please have your product code (on the first page of this instruction, e.g. TD-12345A) and the order number ready, give us a call or email us through our customer care support! We are always ready to assist you!

TEAMSON HOME



Warranty sign up

www.teamsonhome.com

Serving you well gives us great joy!

USA +1(800)935-3959

Mon - Fri 10:00am ~ 2:00pm EST

✉ support@teamson.com

EU +44(0)1952-916-050

Mon - Thu 9:00am ~ 5:00pm GMT

Friday 9:00am ~ 4:00pm GMT

✉ support@teamson.co.uk

ASIA 深圳办公室:

+86(0755)8885-3558.分机号108

Mon - Sat 9:00am ~ 5:00pm GMT+8

✉ sales_ec@teamson.com

台北办公室:

+886(2)2556-6268







Mon - Fri 9:00am ~ 5:00pm GMT+8

✉ sales_ec@teamson.com

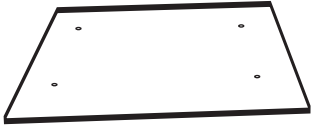
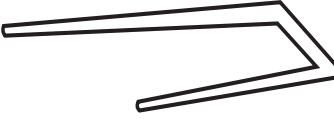
Thank you for choosing Teamson Home

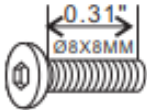
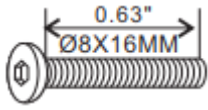
VNF-00026

PARTS LIST

<p>A</p>  <p>1</p>	<p>B</p>  <p>2</p>	<p>C</p>  <p>2</p>
<p>D</p>  <p>2</p>	<p>E</p>  <p>4</p>	<p>F</p>  <p>8</p>
<p>G</p>  <p>5#X80MM</p> <p>1</p>	<p>H</p>  <p>6#X90MM</p> <p>1</p>	<p>I</p>  <p>20X30MM</p> <p>4</p>

▲ Care Instructions

Dust surface with a dry soft cloth.
Do not use window cleaners or cleaning abrasives as they will scratch the surface and could damage the protective coating

▲ WARNING

Small parts and sharp edges may be present prior to assembly.

Step 1

The single side adhesive connect allen key and screws, in case of screw drop.

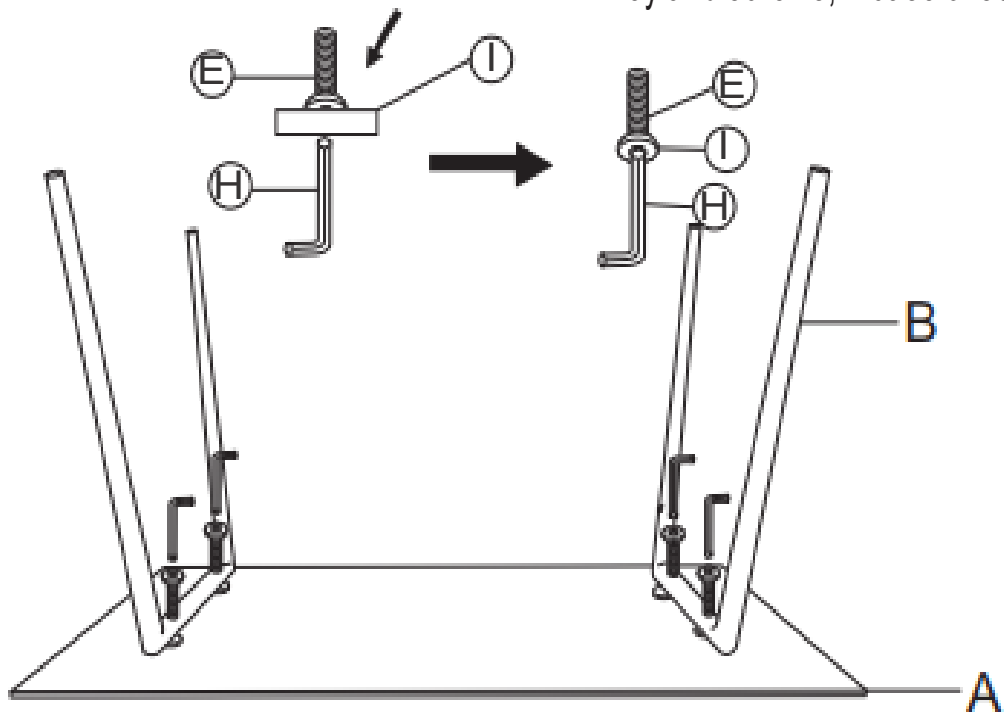

Step 2

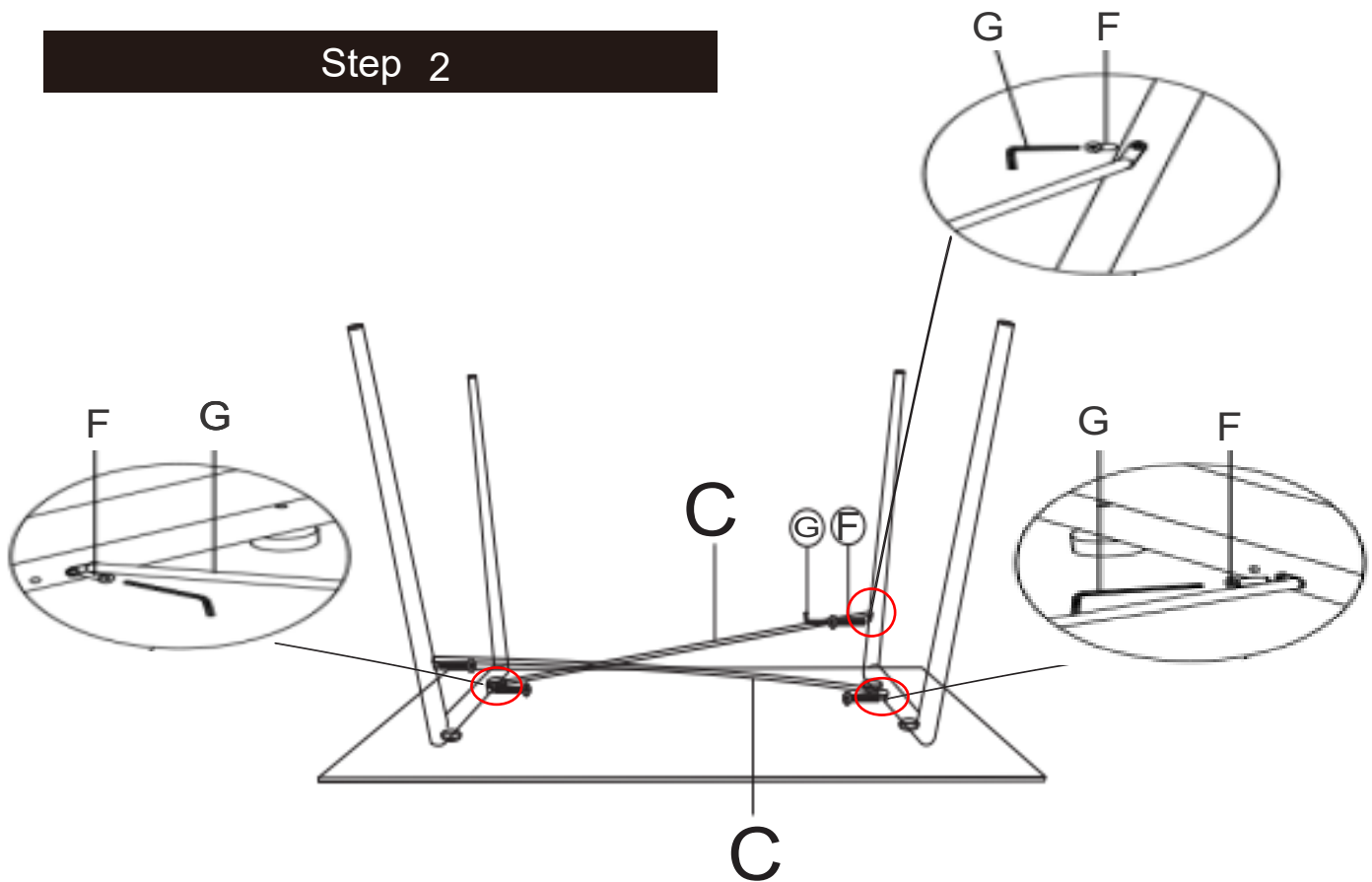

Step 3

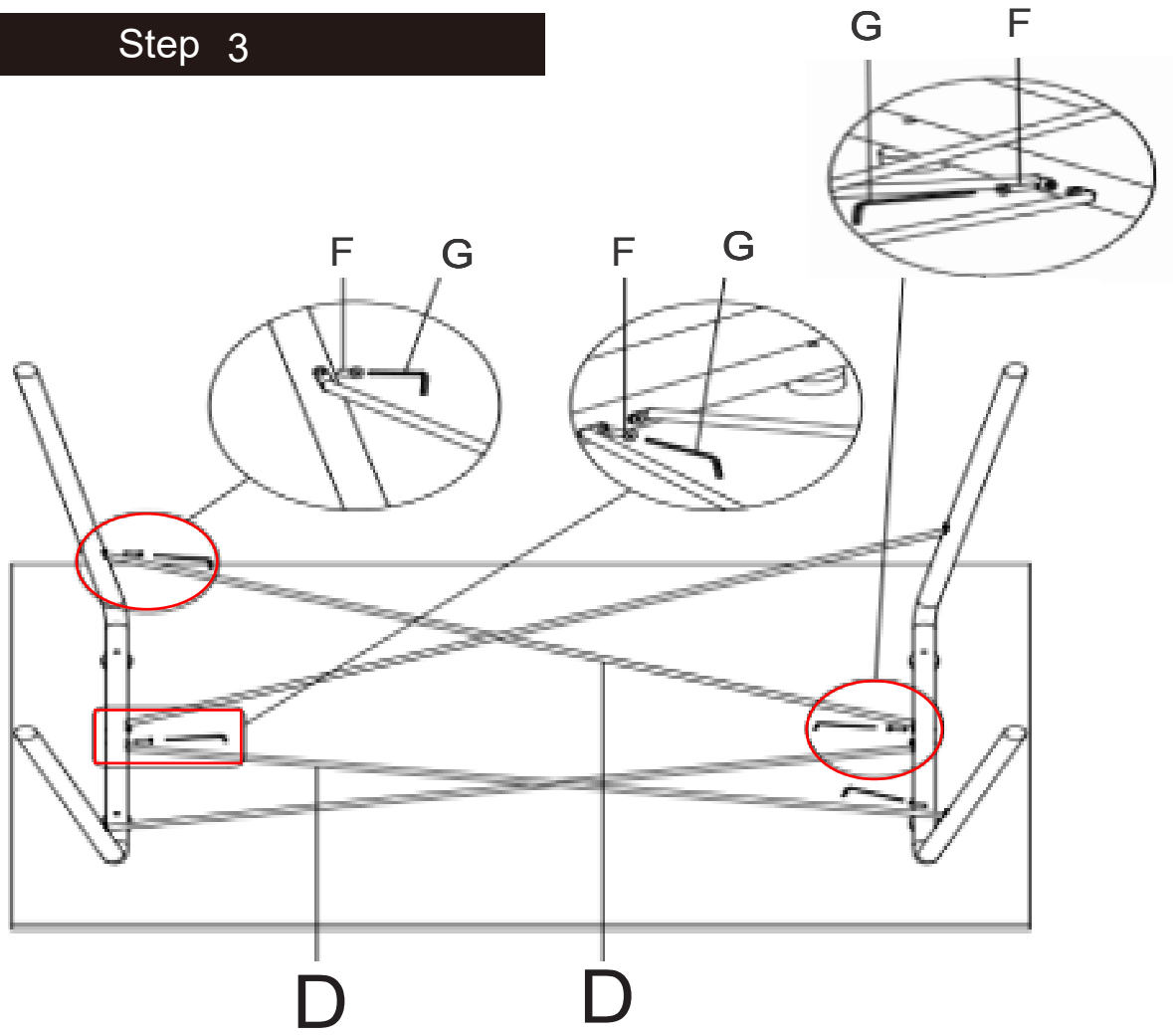

Exploded Drawing

FULL ASSEMBLY

