

Assembly Guide



If you're having any difficulty during assembly of this product, don't hesitate to call us at 1-800-950-4782.

Our customer service experts are trained to provide step-by-step instruction and can easily replace any missing or damaged parts.

Representatives are available Monday-Friday from 8:30 a.m. to 7:30 p.m. (ET)

Straight Workstation

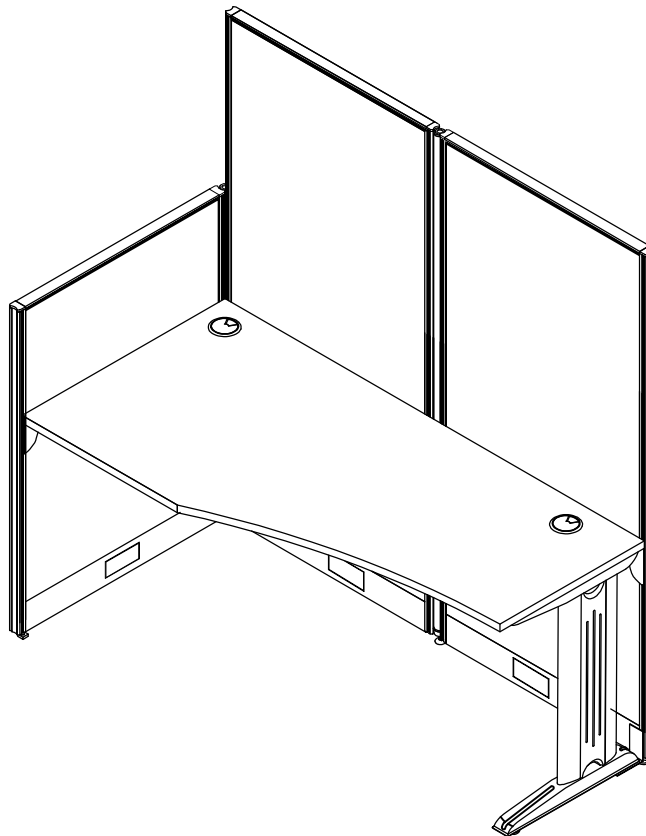

Lot Code #

Part Number A167427D

Keep manual for future reference.



BUSH BUSINESS FURNITURE

Thank you for purchasing this Bush Business Furniture product. We trust that you will be completely satisfied with your product for many years to come. Bush Business Furniture products are backed by a 10-year warranty and crafted with today's styles in mind for the way you work. **Do not return product to store — contact us first at 1-800-950-4782.**

Merci d'avoir acheté ce produit Bush Business Furniture. Nous sommes sûr que vous serez complètement satisfait de votre meuble pendant de nombreuses années. Les produits Bush Business Furniture sont garantis pendant 10 ans et sont conçus dans les styles actuels tout en gardant à l'esprit votre façon de travailler. **Ne renvoyez pas le produit au magasin, contactez-nous d'abord au 1-800-950-4782.**

Gracias por comprar este producto de Bush Business Furniture. Confiamos que usted estará completamente satisfecho con su mueble por muchos años. Los productos de Bush Business Furniture tienen 10 años de garantía y son diseñados con los estilos de hoy en mente para la manera que usted vive. **No devuelva el producto a la tienda, primero comuníquese con nosotros al 1-800-950-4782.**

CONTACT US

Monday – Friday
8:30 a.m. – 7:30 p.m. ET
(Except Holidays)

Bush Consumer Services
One Mason Drive, P.O. Box 460
Jamestown, NY 14701
ConsumerService@Bushindustries.com

1-800-950-4782 USA/CANADA
001-800-950-4782 MEXICO

Se habla español
Outside USA/CANADA/MEXICO
001-716-665-2510 Ext. 4514

A180134

IT'S AS EASY AS 1,2,3

Assembly tips:

1. Read the instructions and become familiar with the parts.
2. Ensure this carton contains all parts, fasteners and hardware.
3. To protect floors, assemble the furniture on the carton.
4. An assistant may be helpful.
5. Use of power tools is not recommended.

Conseils d'assemblage:

1. Lisez les instructions et familiarisez-vous avec les pièces.
2. Assurez-vous que le carton contient toutes les pièces, toutes les pièces de fixation et toute la quincaillerie.
3. Pour protéger vos sols, assemblez le meuble sur le carton.
4. Il peut être utile de vous faire aider.
5. L'utilisation d'outils électriques n'est pas recommandée.

Consejos de Ensamblaje:

1. Lea las instrucciones y familiarícese con las partes.
2. Asegúrese de que esta caja contenga todas las piezas, los sujetadores y el equipo.
3. Para proteger el piso, ensamble el mueble en el carton.
4. Un asistente puede serle útil.
5. El uso de herramientas eléctricas no se recomienda.



CONSUMER
SERVICE

YOU CAN DEPEND ON

Questions? Operators are standing by at our TOLL-FREE help line to assist you with assembly; and, if necessary, to quickly replace damaged/missing parts. Assistance is available 5 days a week. Simply have your store receipt, instruction manual, and part number/description ready when you call our TOLL-FREE help line. It's that easy.

UN SERVICE CLIENTELE SUR LEQUEL VOUS POUVEZ COMPTER

Des questions? Des opérateurs sont prêts sur notre ligne d'assistance GRATUITE pour vous aider à l'assemblage et, si nécessaire, remplacer rapidement les pièces endommagées/manquantes. L'assistance est disponible 5 jours par semaine. Ayez simplement votre reçu de magasin, votre manuel d'instruction et le numéro de pièces/description à votre disposition lorsque vous appelez notre ligne d'assistance GRATUITE. C'est aussi simple que ça.

SERVICIO AL CONSUMIDOR CON EL QUE PUEDE CONTAR

¿Preguntas? Los operadores están listos para ayudarlo con el ensamblaje a través de una línea de ayuda GRATUITA, y en caso de ser necesario, reemplazar de inmediato las piezas dañadas o faltantes. La asistencia está disponible los 5 días de la semana. Solamente tenga listos su recibo de compra, manual de indicaciones y número/descripción de la pieza al momento de llamarnos a la línea de ayuda GRATUITA. Es así de sencillo.

www.bushfurniture.com

For best results, keep these tips in mind:

- ① We know you want to finish this assembly as quickly as possible, but trust us: you'll have a better experience if you take it one step at a time.
- ② Give yourself some room to work near where you want the fully assembled product.
- ③ If your floor isn't carpeted, assemble this product on the empty carton to avoid scratching.
- ④ Do you have a friend who owes you a favor? Some steps may go a little easier with a second set of hands.

DOs

- ✔ Use a #2 Phillips head screwdriver (or other handheld tools as indicated)
- ✔ Wear safety glasses at all times during assembly
- ✔ Carefully follow the instructions in this guide and complete all steps in order
- ✔ Give us a call if you're having trouble with a particularly tricky step

DON'Ts

- ✘ We know power tools are quick and easy, but you shouldn't use them when assembling this product (unless otherwise specified)
- ✘ Never move your furniture with items inside or resting on the surface
- ✘ Do not attempt to use this product before all steps have been completed



Watch assembly videos right on your phone or computer!



Some steps include QR codes that link to helpful videos. Watch out for the icon below! Simply open up your smartphone camera to scan the code.

(Users of older smartphones may need to install a QR Reader.)

SCAN HERE



FOR VIDEOS

Or visit <https://bushfurniture.com/help-faq/#assembling>

IMPORTANT SAFETY INFORMATION



PLEASE READ WARNINGS

Improper use can cause safety hazards, or damage to your furniture and household items.

Warning	Do	Don't	Why it's important
Serious injury may occur.	<ul style="list-style-type: none">Assemble following all instructions using all indicated parts and hardware provided.	<ul style="list-style-type: none">Do not move unit when loaded.Do not load with a television or other heavy equipment.Do not exceed the maximum load limits stated in the instructions.	Improper assembly, use or loading can lead to product instability, tip-over or collapse.

Advertencia	Hacer	No	Por qué es importante
Se pueden producir lesiones graves.	<ul style="list-style-type: none">Ensamble siguiendo todas las instrucciones utilizando todas las piezas y ferretería indicados provistos.	<ul style="list-style-type: none">No mueva la unidad cuando esté cargada.No cargue con un televisor u otro equipo pesado.No exceda los límites máximos de carga establecidos en las instrucciones.	El ensamblaje, uso o carga inadecuados pueden provocar inestabilidad del producto, vuelco o colapso.

Avertissement	Faire	Ne le fais pas	Pourquoi c'est important
Des blessures graves peuvent survenir.	<ul style="list-style-type: none">Assemblez en suivant toutes les instructions en utilisant toutes les pièces et le matériel indiqués fournis.	<ul style="list-style-type: none">Ne déplacez pas l'unité lorsqu'elle est chargée.Ne chargez pas avec un téléviseur ou un autre équipement lourd.Ne dépassez pas les limites de charge maximale indiquées dans les instructions.	Un assemblage, une utilisation ou un chargement incorrects peuvent entraîner une instabilité du produit, un renversement ou un effondrement.

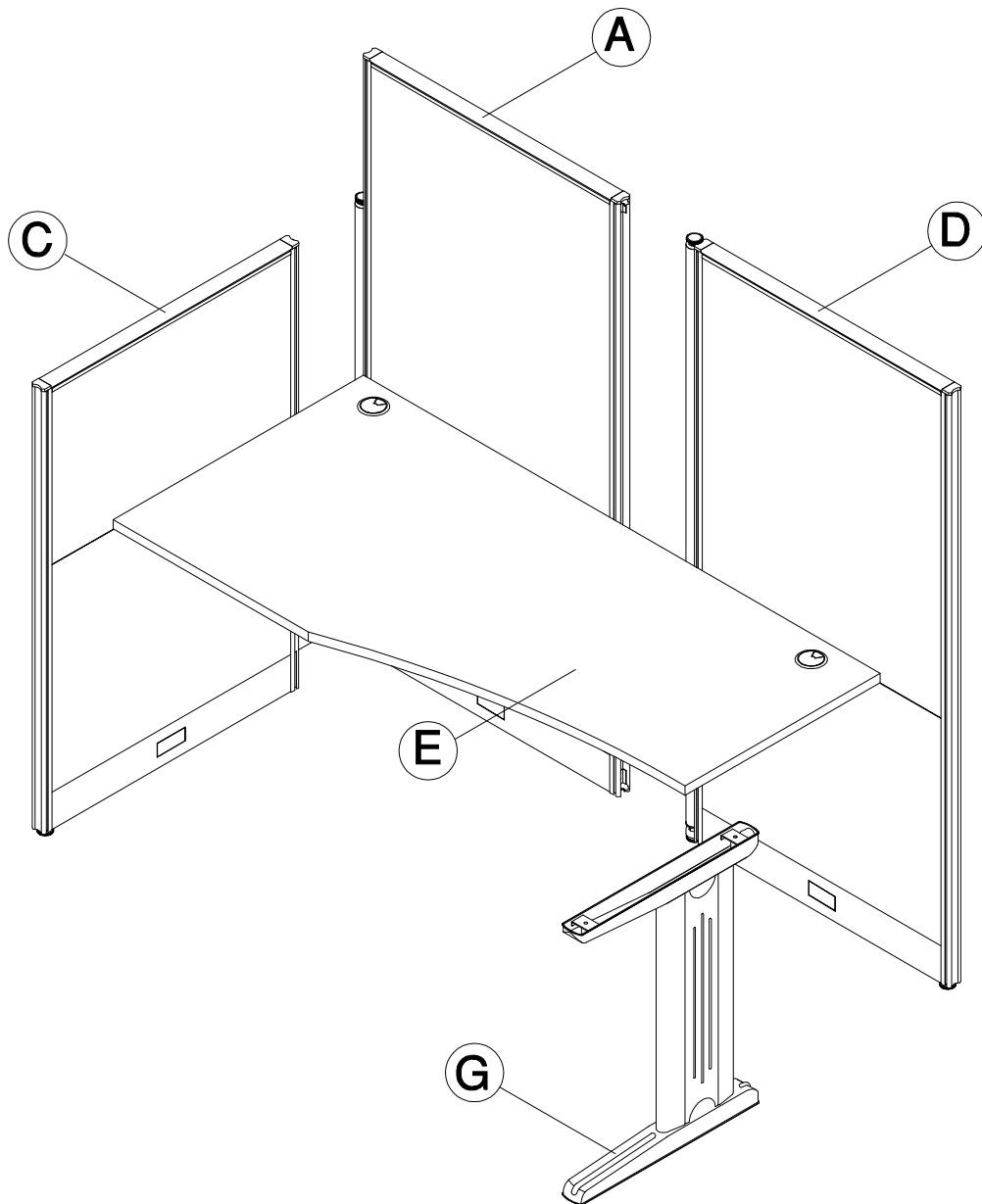
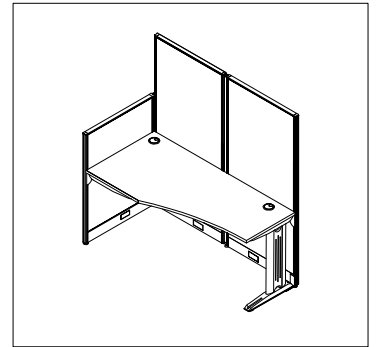

Have an assembly question or need a replacement part? Just call
1-800-950-4782, we are here to help.

Get to know your Boards

A167427D

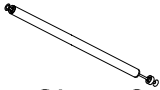
H146902  [1]
Short Conn. Tube

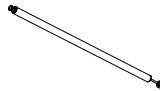
H146903  [1]
Tall Conn. Tube

H153719  [6]
Wire Access Grommet

H146905  [3]
Leg Leveler

H147237  [2]
Prt. Leveler/Cap

WC36492 / WC36892

H211155  [2]
Grommet

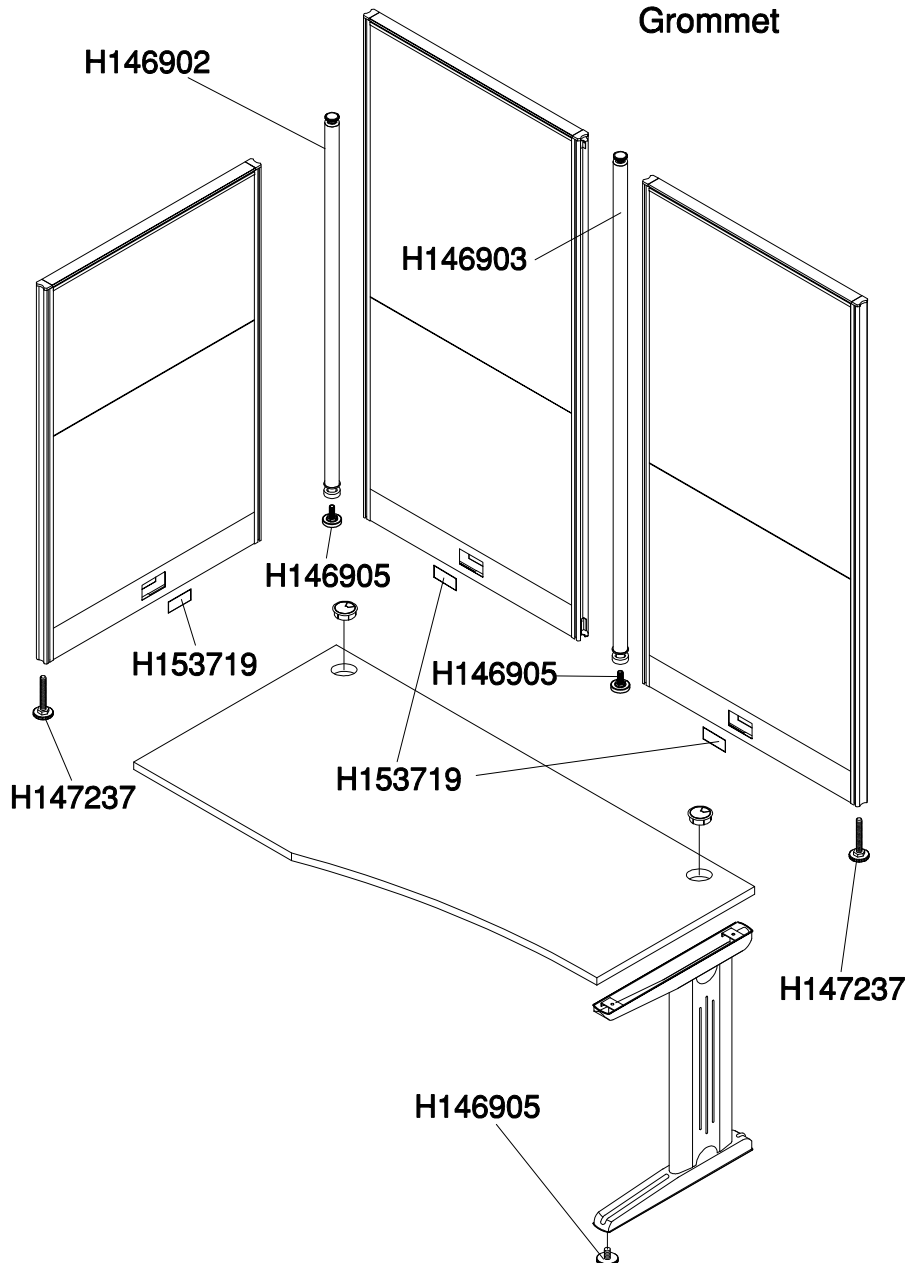

Have an assembly question or need a replacement part? Just call
1-800-950-4782, we are here to help.

Fasteners are shown actual size.

H148756

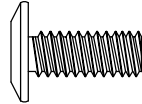

[2]

M6x15mm

H148749

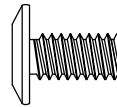

[11]

M6x12mm

H146895

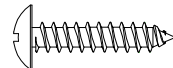

[2]

#8x3/4"

Have an assembly question or need a replacement part? Just call
1-800-950-4782, we are here to help.

Hardware not to scale.

H146904

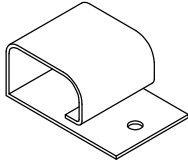

[2]

Cord Management

H148745

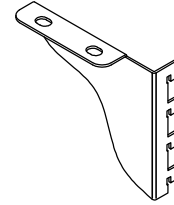

[2]

Rt. Sup. Bracket

H148746

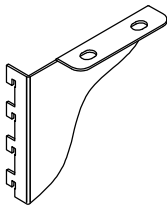

[2]

Lft. Sup. Bracket

H146908

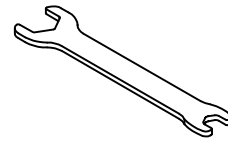

[1]

Wrench

H148747

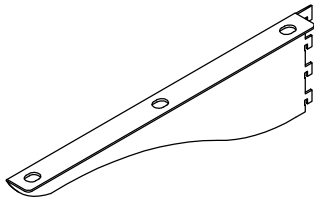

[1]

Sng. Sup. Bracket

H146899

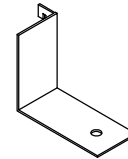

[1]

Rt. Leg. Sup. Bracket

H153561

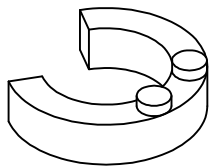

[2]

Spacer Nylon Silver

H146905

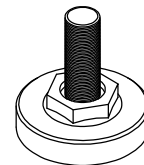

[1]

Leg Leveler

H146907

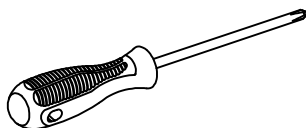

[1]

Screwdriver

Have an assembly question or need a replacement part? Just call
1-800-950-4782, we are here to help.

STEP 1

Assemble Panels

A167427D

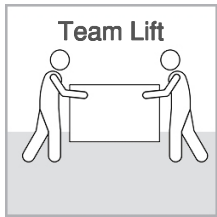

Remove bag first
Enlevez le sac en premier
Retire La bolsa primero

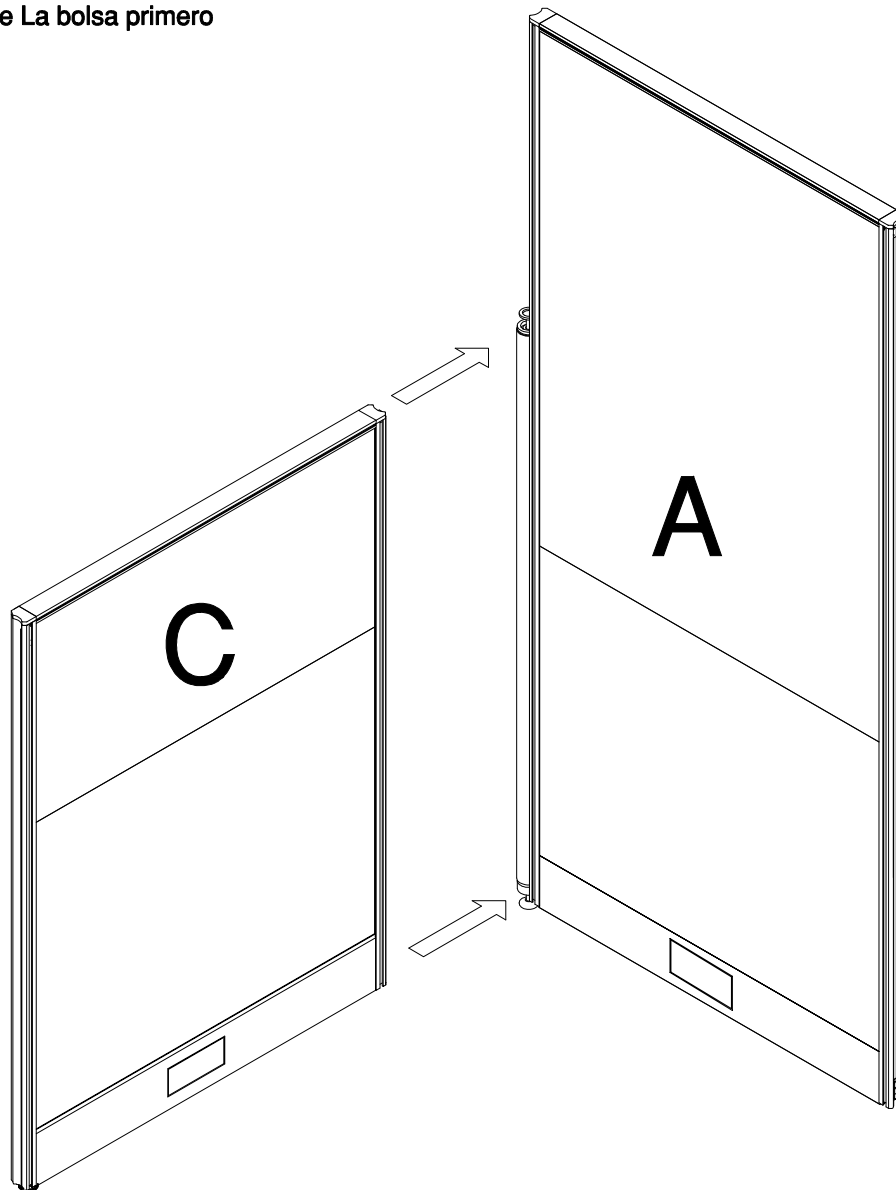

1 Loosen
aflojar
desserrez

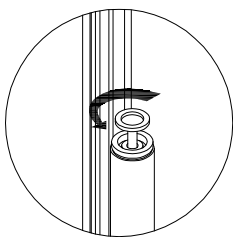

2 Assemble
ensamblar
réunissez

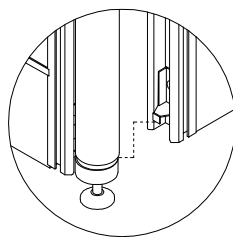

3 Assemble
ensamblar
réunissez

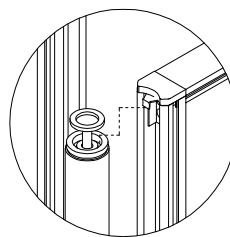

4 Tighten
Apretar
serrez

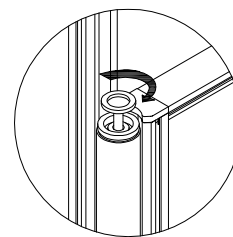

Have an assembly question or need a replacement part? Just call
1-800-950-4782, we are here to help.

STEP 2

Assemble Panels

A167427D

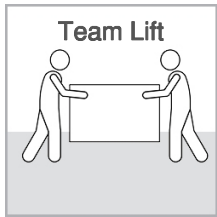

H153561

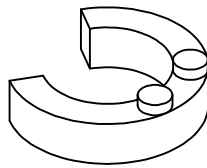

[1]

Spacer Nylon Silver

Remove bag first
Enlevez le sac en premier
Retire La bolsa primero

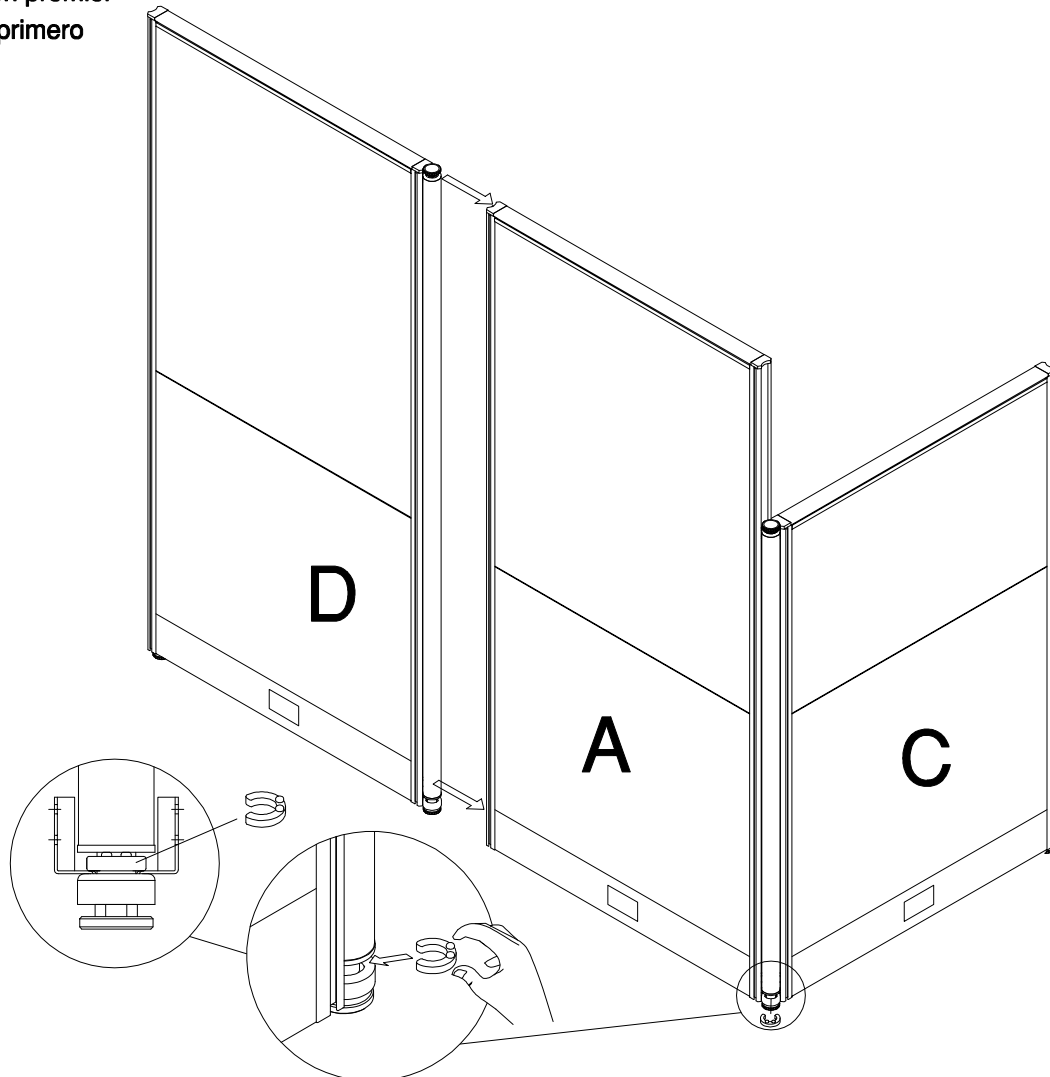

1 Loosen
aflojar
desserrez

2 Assemble
ensamblar
réunissez

3 Assemble
ensamblar
réunissez

4 Tighten
Apretar
serrez

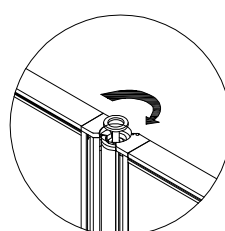
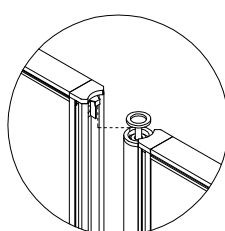
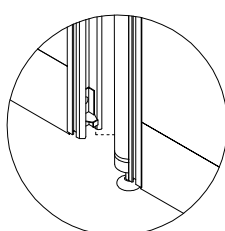
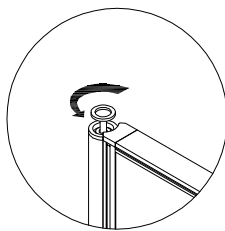

Have an assembly question or need a replacement part? Just call
1-800-950-4782, we are here to help.

STEP 3

Install Hardware

A167427D

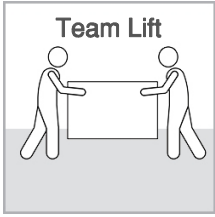

H153561

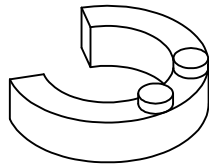

[1]

Spacer Nylon Silver

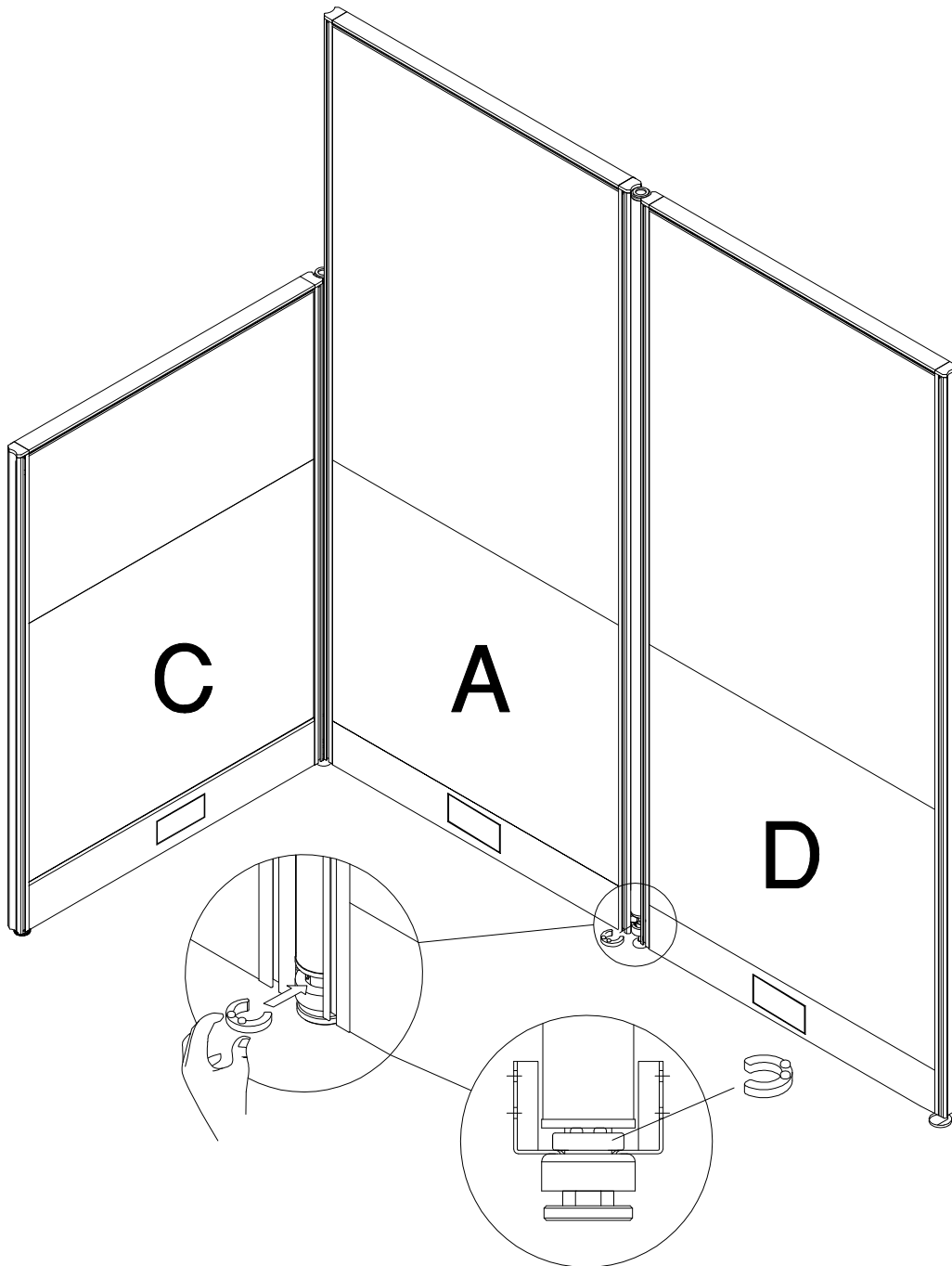

Have an assembly question or need a replacement part? Just call
1-800-950-4782, we are here to help.

STEP 4

Install Hardware

A167427D

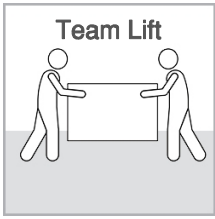

H148746

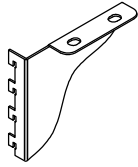

[2]

Lft.Sup.Bracket

H148745

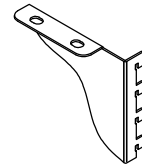

[2]

Rt.Sup.Bracket

H148747

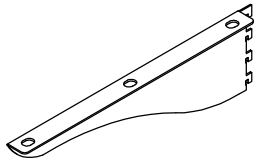

[1]

Sng.Sup.Bracket

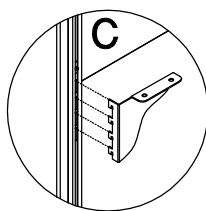
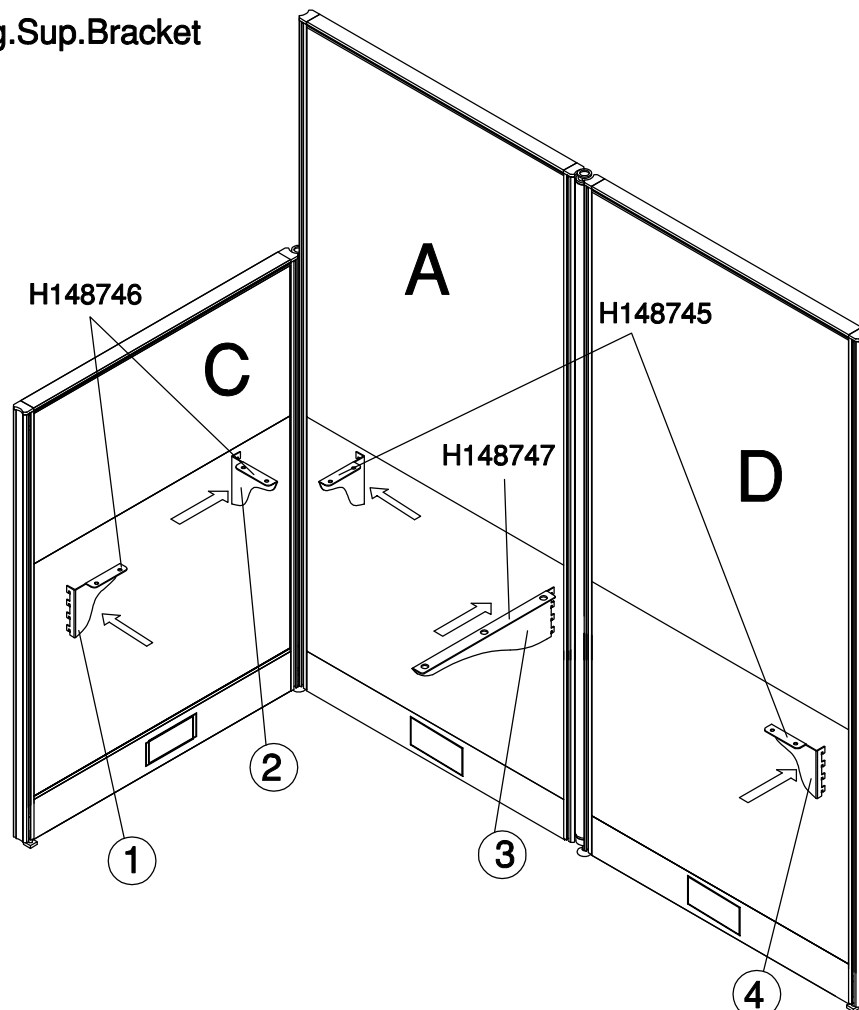

1

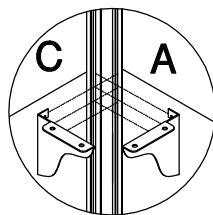

2

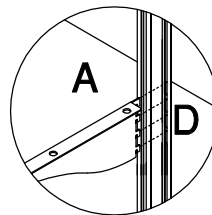

3

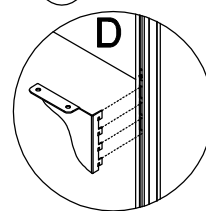

4

Have an assembly question or need a replacement part? Just call
1-800-950-4782, we are here to help.

STEP 5

Install Hardware

A167427D

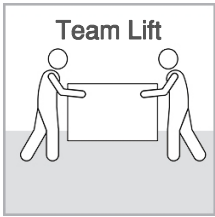

H146905

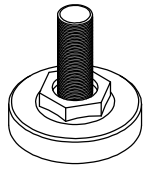

Leg Leveler

[1]

H146899

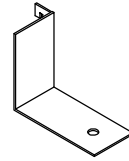

[1]

Rt.Leg.Sup.Bracket

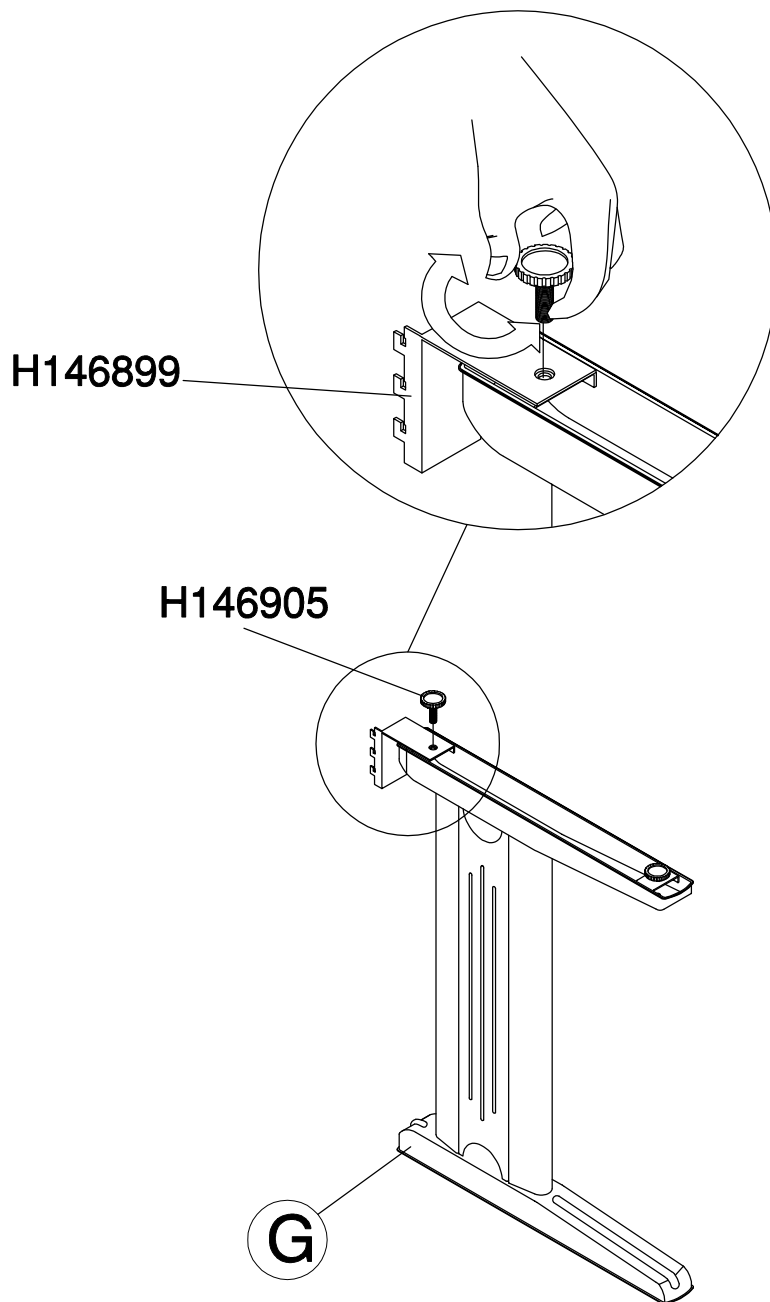

Have an assembly question or need a replacement part? Just call
1-800-950-4782, we are here to help.

STEP 6

Install Hardware

A167427D

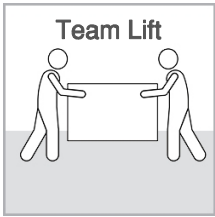

Please loosen the screw first, place it just above the bracket, then tighten
Primero afloje el tornillo, colóquelo sobre el soporte, luego apriete
Veuillez desserrer la vis d'abord, la placer juste au-dessus du croisillon, puis serre

H146907

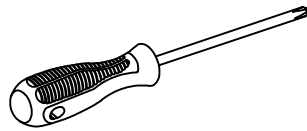

Screwdriver

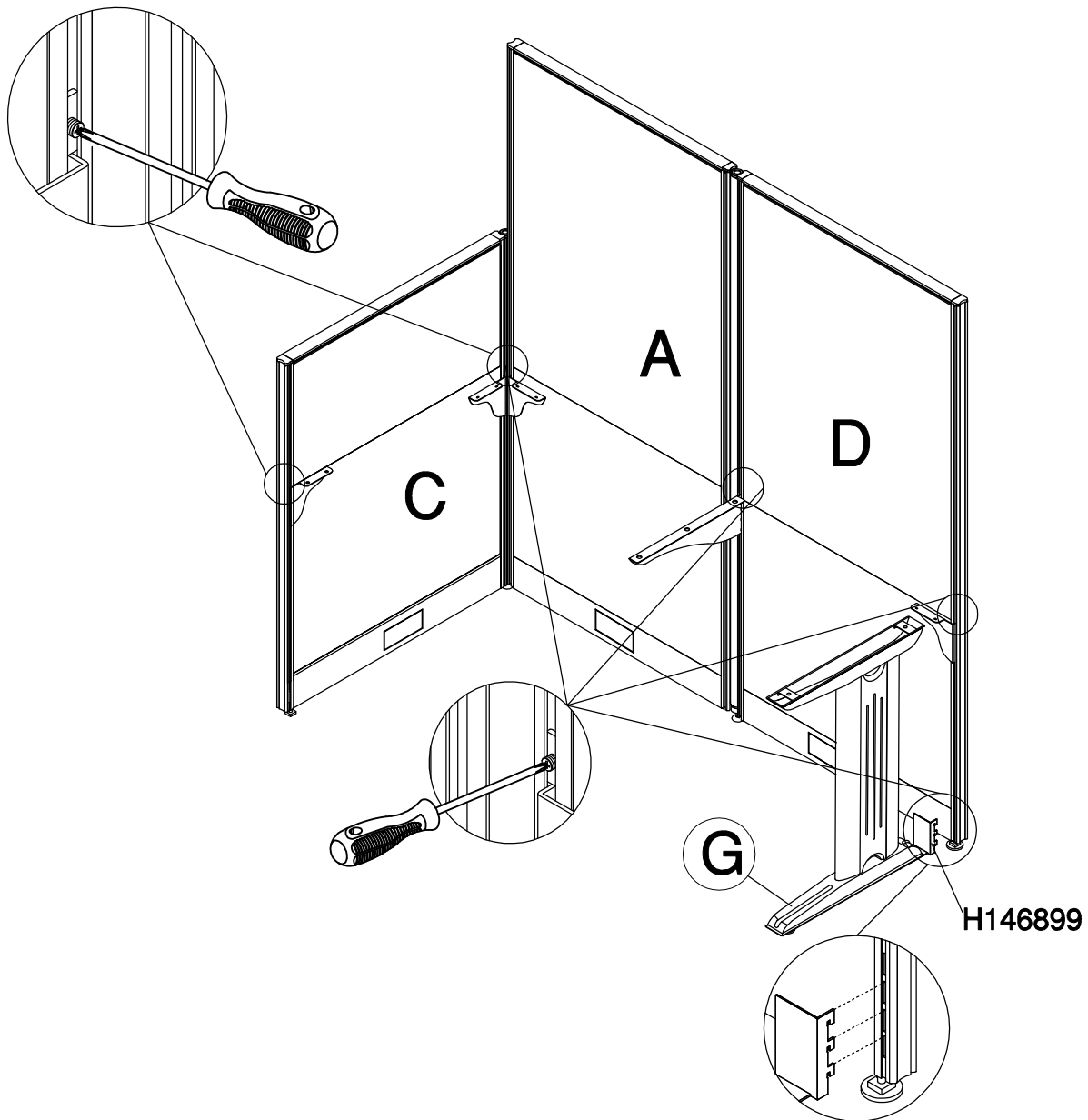

Have an assembly question or need a replacement part? Just call
1-800-950-4782, we are here to help.

STEP 7

Prepare Panels

A167427D

H146904

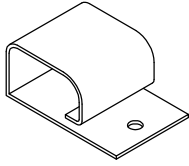

[2]

Cord Management

H146907

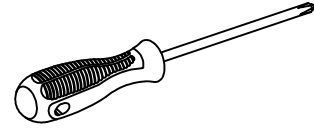

Screwdriver

H146895

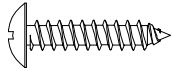

[2]

#8x3/4"

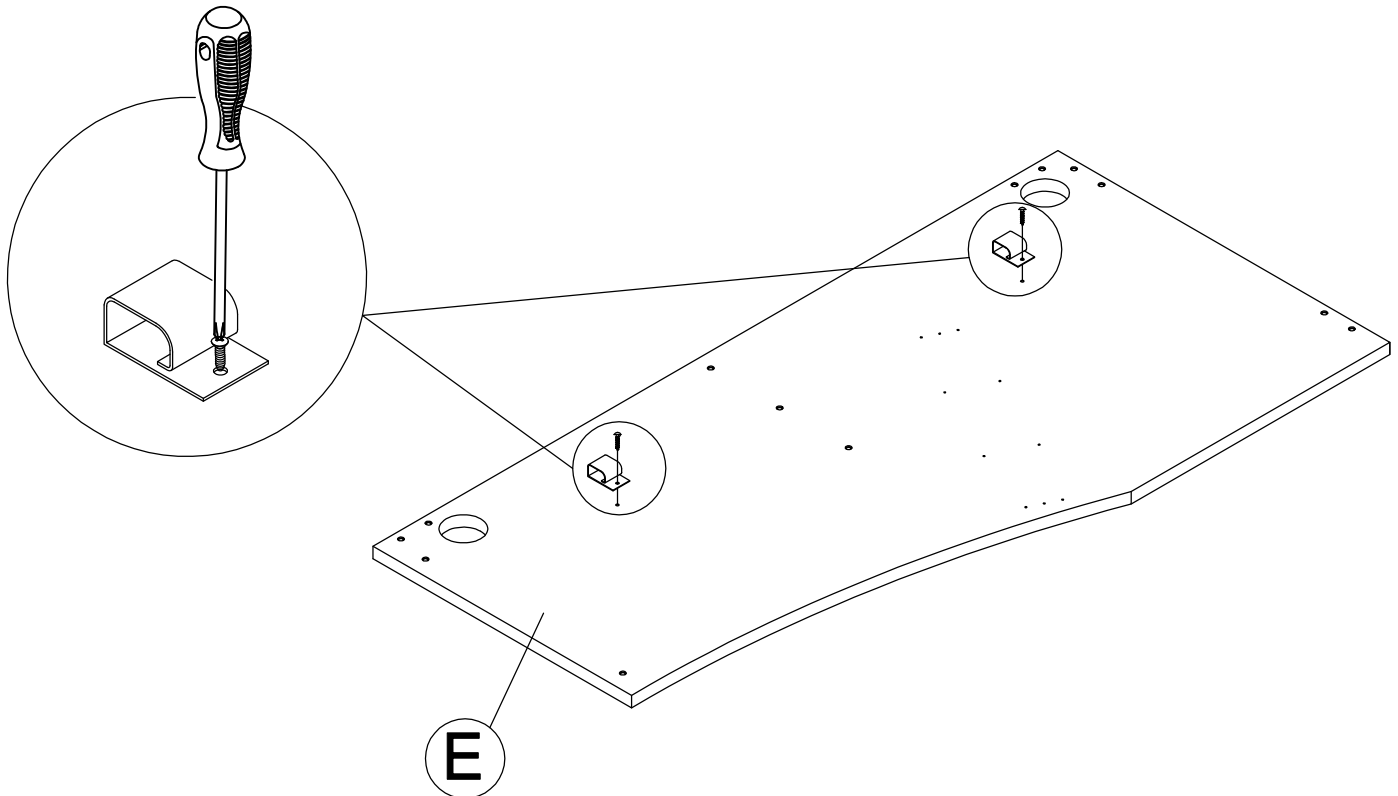

Have an assembly question or need a replacement part? Just call
1-800-950-4782, we are here to help.

STEP 8

Assemble Panels

A167427D

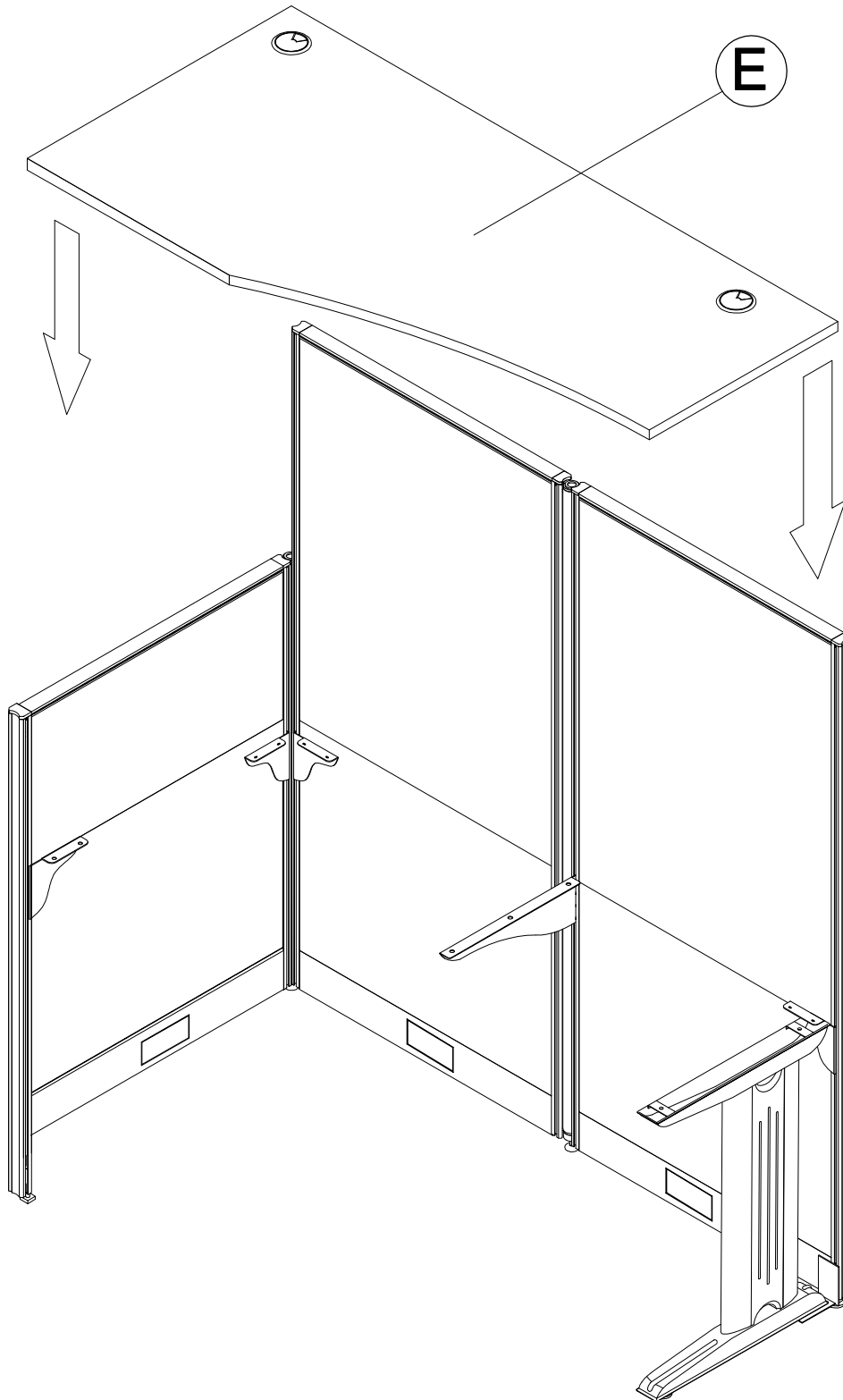
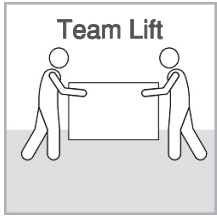

Have an assembly question or need a replacement part? Just call
1-800-950-4782, we are here to help.

STEP 9

Assemble Panels

A167427D

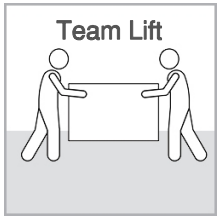

H146907

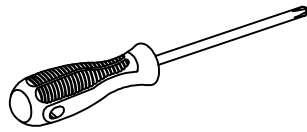

Screwdriver

H148756

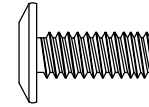

[2]

M6x15mm

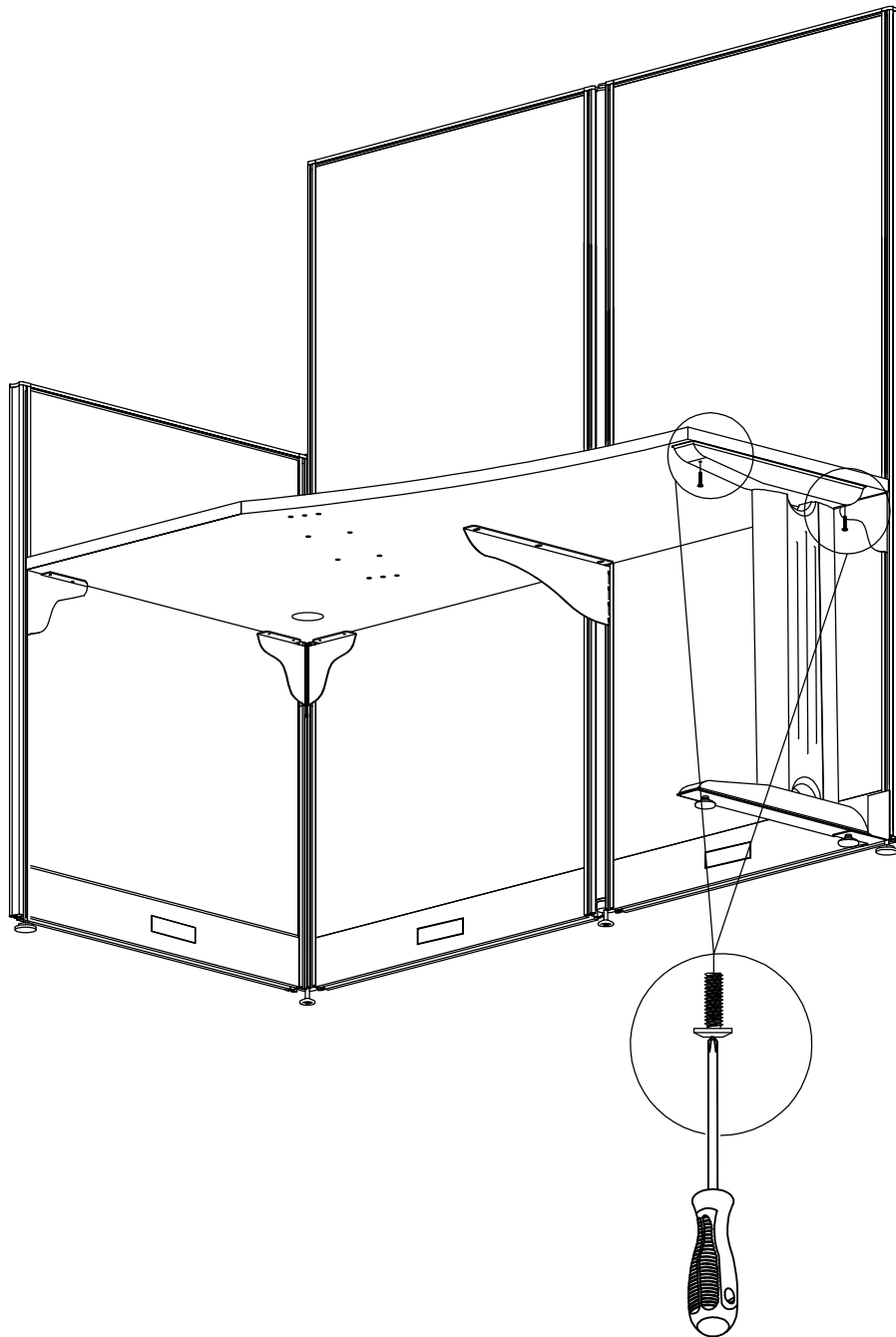

Have an assembly question or need a replacement part? Just call
1-800-950-4782, we are here to help.

STEP 10

Assemble Panels

A167427D

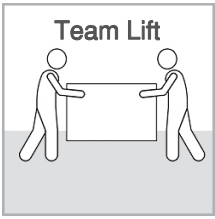

H148749

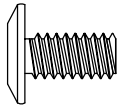

[11]

M6x12mm

H146907

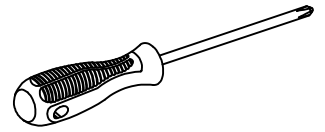

Screwdriver

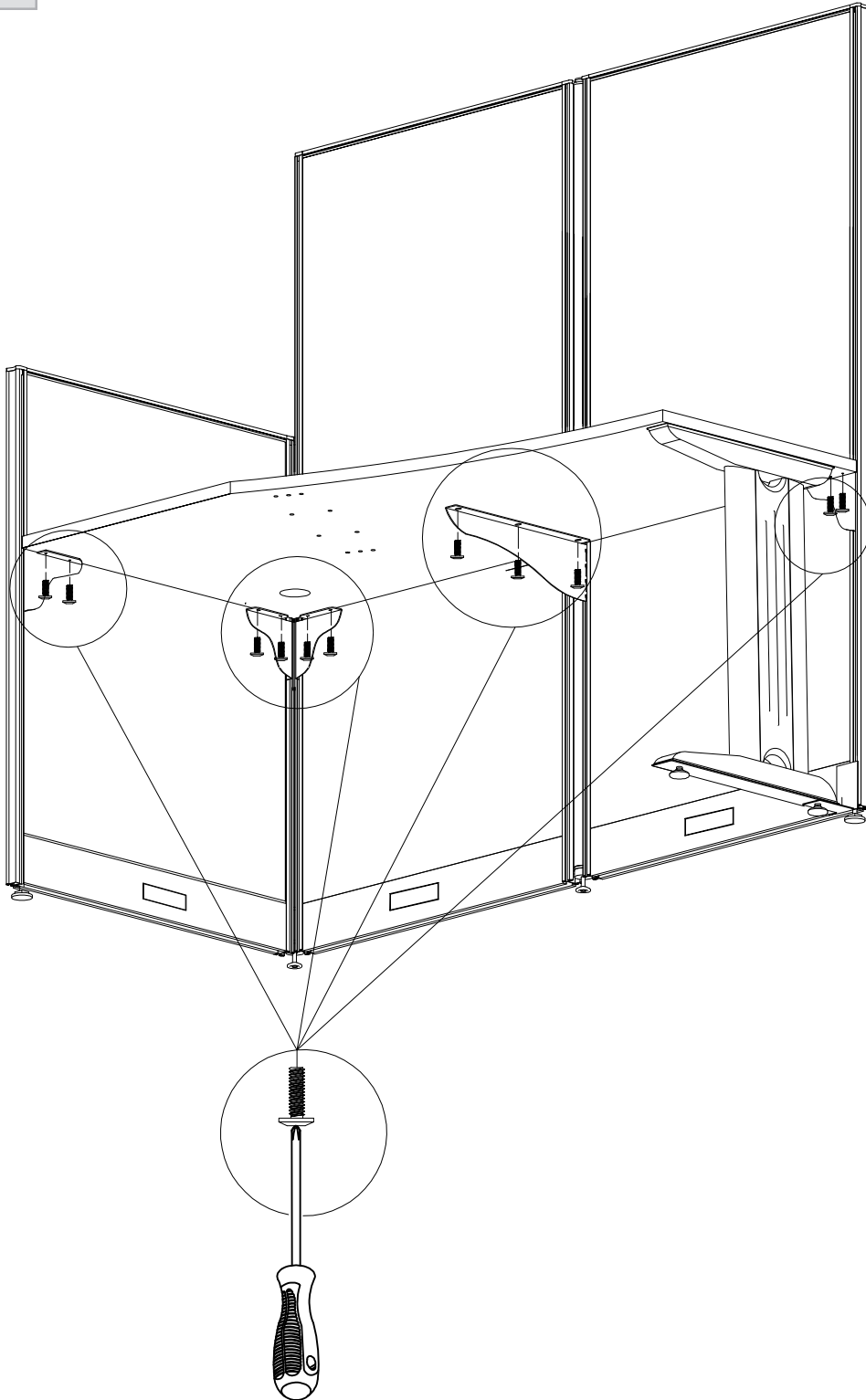

Have an assembly question or need a replacement part? Just call
1-800-950-4782, we are here to help.

STEP 11

Adjust Leg Leveler

A167427D

H146908

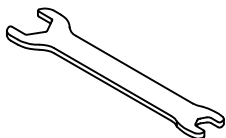

[1]

Wrench

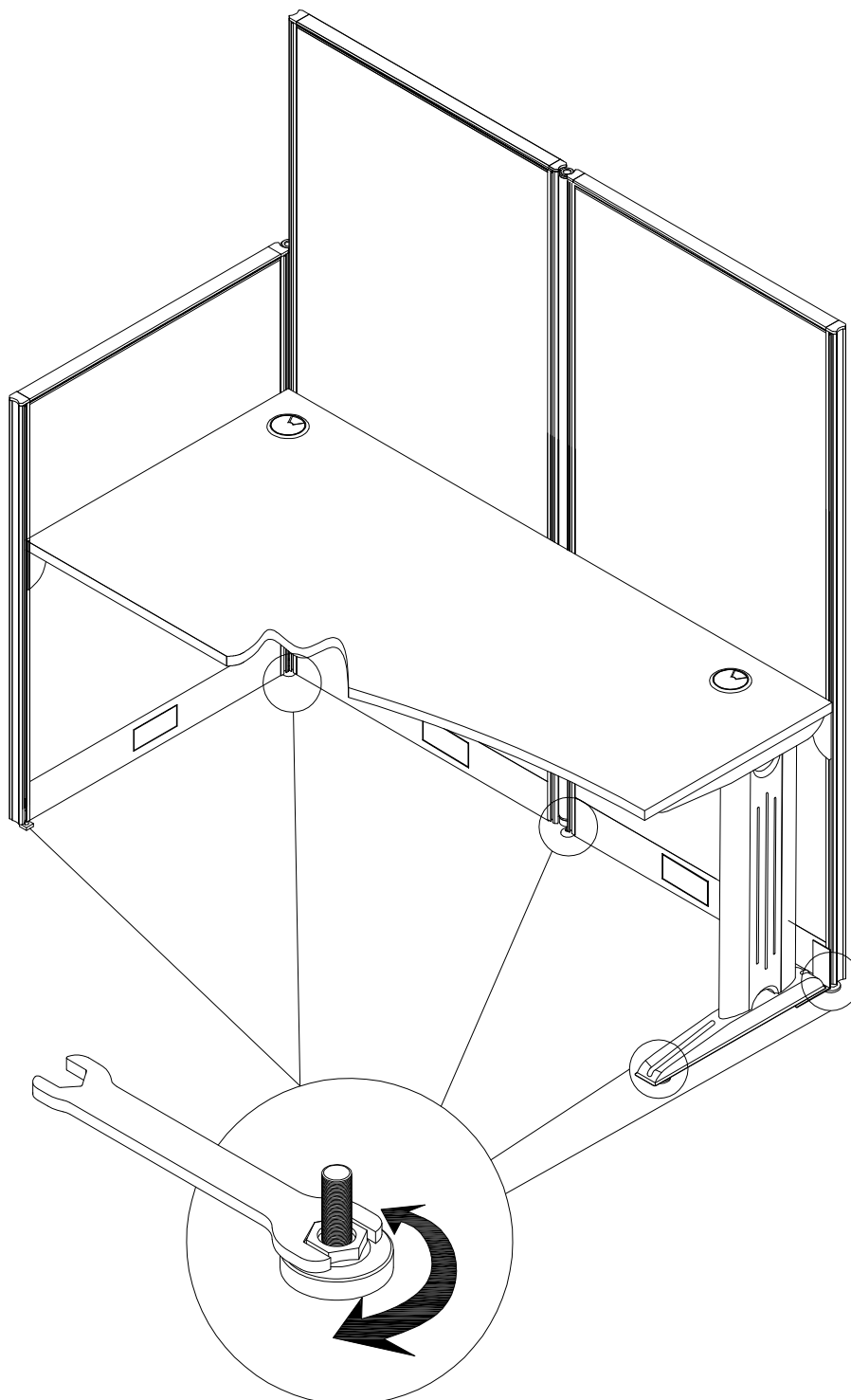

Have an assembly question or need a replacement part? Just call
1-800-950-4782, we are here to help.

STEP 12

Maximum Loading and Cleaning

A167427D

Scan QR Code to
Watch Video on:



How to Clean
the Surface

Gently clean
surfaces with a damp
sponge eraser.

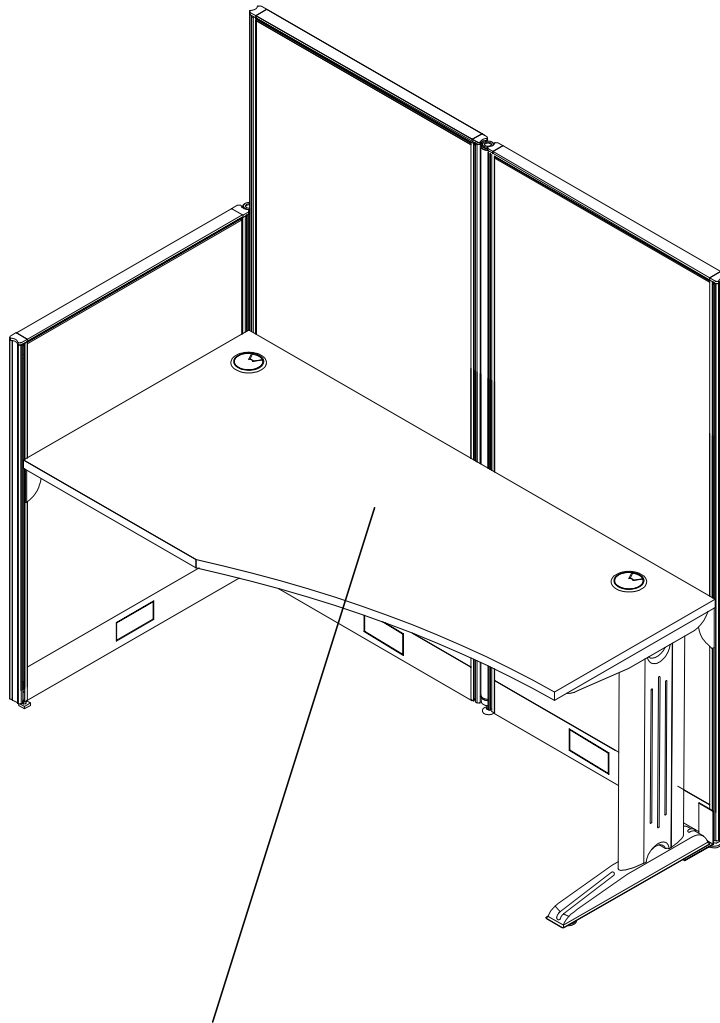

MAXIMUM WEIGHT: 200 LBS (90.9 KG)

PESO MÁXIMO: 200 LIBRAS (90.9 KILOGRAMO)

POIDS MAXIMUM: 200 LIVRES (90.9 KILOGRAMME)

**Congratulations! You are all done. If you
have any questions or concerns, please call.**

**Have an assembly question or need a replacement part? Just call
1-800-950-4782, we are here to help.**

WC36492

A [1] S146909
C [1] S147114
D [1] S146912
E [1] S148742
G [1] H150931

WC36892

A [1] S175252
C [1] S175253
D [1] S175254
E [1] S175255
G [1] H150931

THIS PAGE INTENTIONALLY LEFT BLANK

THIS PAGE INTENTIONALLY LEFT BLANK

WARRANTY INFORMATION/INFORMATIONS POUR LA GARANTIE/INFORMACIÓN DE GARANTÍA

BUSH BUSINESS FURNITURE'S WRITTEN WARRANTY TO YOU

In order to provide you with timely assistance, please thoroughly inspect your furniture for missing or defective parts immediately after opening the carton. To receive replacement or missing parts under this warranty, call our Consumer Service Department TOLL-FREE at 1-800-950-4782. Please have the Model, Part, and Lot Numbers found in the instruction manual available for your reference. You will also need your sales receipt or other proof of purchase. Replacement part(s) will be shipped to you at no charge with Bush Industries assuming all shipping and handling charges.

This Bush Business Furniture product is warranted to the original purchaser at the time of purchase and for a period of ten years thereafter.

We warrant to you, the original purchaser, that our furniture and all its parts and components are free of defects in material or workmanship. "Defects," as used in this warranty, is defined as any imperfection which impairs the use of the furniture product.

Our warranty is expressly limited to the replacement of furniture parts and components. Except for the limitations listed below, for ten years after the date of purchase, Bush will replace parts that are defective in material or workmanship.

Limitations involving materials and components: The materials and components listed below are covered according to the following schedule from the date of sale:

- Five Years – Glides, casters, polymer-based components, panel, upholstery fabrics, foam, laminates, veneer finishes, and other covering materials.
- One Year – Metal mechanism and related components in manual height adjustable products.

This warranty applies under conditions of normal use. Our Bush Business Furniture products are not intended for outdoor use. This warranty does not cover: 1) defects caused by improper assembly or disassembly; 2) defects occurring after purchase due to product modification, intentional damage, accident, misuse, abuse, negligence or exposure to the elements; and 3) labor or assembly costs. 4) batteries are not included.

IMPLIED WARRANTIES, INCLUDING THE WARRANTY OF MERCHANTABILITY, SHALL NOT EXTEND BEYOND THE DURATION OF THE WRITTEN WARRANTY STATED ABOVE, AND IN NO EVENT SHALL BUSH BE LIABLE FOR INCIDENTAL OR CONSEQUENTIAL DAMAGES RESULTING FROM USE OF THE PRODUCT. Some states do not allow a limitation on how long an implied warranty lasts or the exclusion or limitation of incidental or consequential damages, so the above limitation and exclusion may not apply to you.

This warranty gives you specific legal rights. You may also have other rights that may vary from state to state.

VOTRE GARANTIE BUSH BUSINESS FURNITURE

Afin de vous assister rapidement, veuillez inspecter votre mobilier en détail immédiatement après l'ouverture du carton en cas de pièces manquantes ou défectueuses. Pour recevoir une pièce de rechange ou manquante couverte par cette garantie, appelez notre département de service clientèle GRATUITEMENT au 1-800-950-4782. Veuillez tenir à disposition les numéros de modèle, de pièce et de lot qui se trouvent dans le manuel d'instruction pour votre référence. Vous aurez également besoin de votre reçu ou d'une autre preuve d'achat. La (les) pièce(s) de rechange vous sera (seront) envoyée(s) sans frais, Bush Industries se chargeant de tous les frais d'expédition.

Tout le produit Bush Business Furniture est garanti à l'acheteur original à partir de la date d'achat pour une période d'e dix ans. Nous vous garantissons, à vous l'acheteur original, que notre mobilier et toutes ses pièces et composants sont sans défaut de matériau ou de fabrication. Le terme "défauts" utilisé dans cette garantie, est défini comme étant toutes les imperfections qui compromettent l'utilisation du meuble.

Notre garantie est expressément limitée au remplacement des pièces et des composants du mobilier. Sauf les limitations énumérées ci-dessous, pendant dix ans après la date d'achat, Bush remplacera toute pièce défectueuse dans le matériau ou sa fabrication.

Limitations impliquant des matériaux et des composants: Les matériaux et composants énumérés ci-dessous sont couverts conformément au calendrier suivant à compter de la date de vente:

- Cinq ans - Glissements, roulettes, composants à base de polymères, panneaux, tissus d'ameublement, mousse, stratifiés, finitions de placage et autres matériaux de revêtement.
- Un an - Mécanisme métallique et composants associés dans des produits à réglage manuel de la hauteur.

Cette garantie d'applique sous des conditions d'utilisation normale. Nos produits ne sont pas destinés à être utilisés en plein air. Cette garantie ne couvre pas: 1) les défauts causés par un mauvais assemblage ou démontage, 2) les défauts ayant lieu après l'achat et dus à la modification du produit, des dommages intentionnels, des accidents, une mauvaise utilisation, un mauvais traitement, la négligence ou l'exposition aux éléments, et 3) les frais de main d'œuvre ou d'assemblage. 4) les piles ne sont pas incluses.

LES GARANTIES TACITES, Y COMPRIS LA GARANTIE DE QUALITE MARCHANDE, NE S'ETENDRONT PAS AU-DELA DE LA DUREE ECRITE CITEE CI-DESSUS, ET BUSH NE SERA EN AUCUN CAS RESPONSABLE DES DOMMAGES ACCESSOIRES OU INDIRECTS RESULTANT DE L'UTILISATION DU PRODUIT. Certains états ne permettent pas d'appliquer une limite à la durée de la garantie tacite, ni une exclusion ou limitation des dommages accessoires ou indirects; dans ce cas les limitations ou exclusion ci-dessus peuvent ne pas s'appliquer à vous.

Cette garantie vous donne des droits légaux spécifiques. Il se peut que vous ayez également d'autres droits qui peuvent varier d'un état à l'autre.

GARANTIA ESCRITA DE BUSH BUSINESS FURNITURE PARA USTED

Para brindarle asistencia oportuna, por favor, verifique detalladamente que a su mueble no le falte o tenga piezas defectuosas inmediatamente después de abrir la caja. Pararecibir un reemplazo o la parte faltante bajo esta garantía, llame a nuestro Departamento de Servicio al Consumidor GRATIS al 1-800-950-4782. Sírvase traer los números de modelo, parte y lote que se encuentran en el manual de instrucciones disponible para su referencia. Además, necesitará el recibo de su compra u otra prueba de compra. La(s) pieza(s) de reemplazo le será(n) enviada(s) sin recargo por Bush Industries asumiendo los gastos de envío y manipuleo.

Todo mueble de Bush Business Furniture es garantizado al comprador original al momento de la compra y por un periodo de diez años en adelante.

Le garantizamos a usted, el comprador original, que nuestros muebles sus partes y componentes están libres de defectos en materiales o trabajo. "Defectos", según se usa en esta garantía, se define como una imperfección que perjudica el uso del producto mobiliario.

Nuestra garantía se limita expresamente al reemplazo de partes y componentes mobiliarios. Excepto las limitaciones enumeradas a continuación, durante diez años después de la fecha de compra, Bush reemplazará cualquier parte defectuosa en material o trabajo.

Limitaciones que involucran materiales y componentes: Los materiales y componentes que se enumeran a continuación están cubiertos de acuerdo con el siguiente calendario a partir de la fecha de venta:

- Cinco años: deslizadores, ruedas, componentes a base de polímeros, paneles, telas de tapicería, espuma, laminados, acabados de enchapado y otros materiales de recubrimiento.
- Un año: mecanismo de metal y componentes relacionados en productos de altura manual.

Esta garantía se aplica bajo condiciones de uso normal. Nuestros productos de Bush Business Furniture no son para uso en exteriores. Esta garantía no cubre: 1) defectos causados por un ensamblaje o desensamblaje inadecuado; 2) defectos que ocurren después de la compra debido a modificación del producto, daño intencional, accidente, mal uso, abuso, negligencia o exposición a los elementos; y 3) costos de trabajo o ensamblaje. 4) las baterías no están incluidas.

LAS GARANTÍAS IMPLICADAS, INCLUYENDO LA GARANTÍA DE COMERCIABILIDAD, NO SE EXTENDERÁN MÁS ALLÁ DE LA DURACIÓN DE LA GARANTÍA ESCRITA MENCIONADA, Y EN NINGÚN CASO BUSH SERÁ RESPONSABLE POR DAÑOS INCIDENTALES O CONSIGUIENTES COMO RESULTADO DEL USO DEL PRODUCTO. Algunos estados no permiten una limitación sobre el tiempo de duración de la garantía implicada o la exclusión o limitación de daños incidentales o consiguientes, de manera que la limitación y exclusión mencionadas pueden no aplicarse para usted.

Esta garantía le otorga derechos legales específicos. Puede también tener otros derechos que pueden variar según los estados.

10-Year
Manufacturer's
Warranty

Register your product online:

Scan the QR Code or go to
[https://bushfurniture.com/
activate-warranty/](https://bushfurniture.com/activate-warranty/)



Assembly tips & how to videos:

Scan the QR Code to access our video guides
[https://bushfurniture.com/
help-faq/#assembling](https://bushfurniture.com/help-faq/#assembling)

