







# ASSEMBLY INSTRUCTIONS

## Parts required

1		Bolt	Φ6*10MML	16pcs
2		Allen wrench		1pc

A		1pc
---	---	-----

B		1pc
C		2pcs
D		2pcs

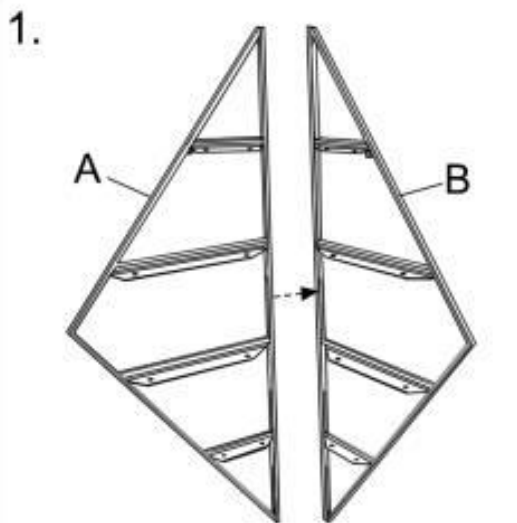

The frames should be perpendicular to one another.

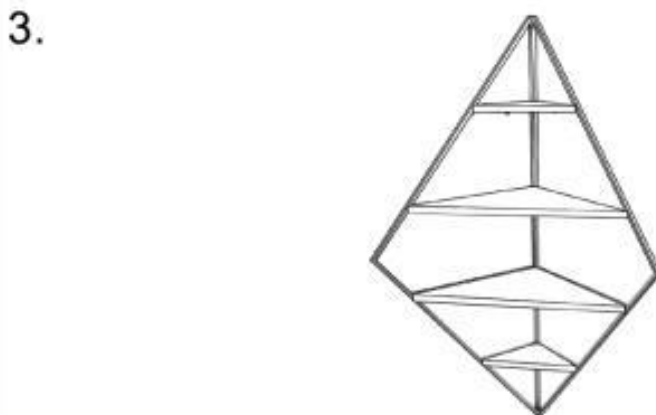
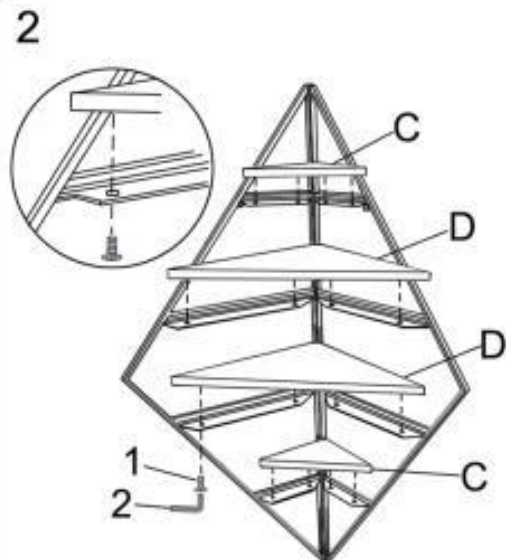

The slotted hole is to allow adjustability to fit the corner.