

(A)

x1 Chair cushion \*  
x1 Coussin de chaise  
x1 Cojín de silla



(B)

x2 Front Leg \*  
x2 Patte avant  
x2 Pata delantera

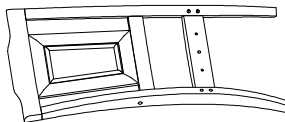

(C)

x1 Chair Back \*  
x1 Dossier de chaise  
x1 Respaldo de la silla



(D)

x1 Left Chair Arm \*  
x1 Accoudoir gauche  
x1 Brazo izquierdo

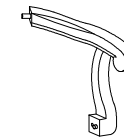

(E)

x1 Right Chair Arm \*  
x1 Accoudoir droit  
x1 Brazo derecho



(F)

x4 Allen Bolt Ø1/4" x 40mm \*  
x4 Vis à tête creuse hexagonale  
Ø1/4 " x 40mm  
x4 Perno Allen Ø1/4 " x 40mm



(G)

x4 Allen Bolt Ø1/4" x 76mm \*  
x4 Vis à tête creuse hexagonale  
Ø1/4 " x 76mm  
x4 Perno Allen Ø1/4 " x 76mm



(H)

x4 Allen Bolt Ø1/4" x 55mm \*  
x4 Vis à tête creuse hexagonale  
Ø1/4 " x 55mm  
x4 Perno Allen Ø1/4 " x 55mm

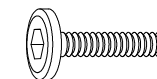

(I)

x2 Allen Bolt Ø1/4" x 45mm \*  
x2 Vis à tête creuse hexagonale  
Ø1/4 " x 45mm  
x2 Perno Allen Ø1/4 " x 45mm



(J)

x14 Lock Washer Ø1/4" \*  
x14 Rondelle de blocage Ø1/4 "  
x14 Arandela de seguridad Ø1/4"

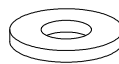

(K)

x12 Flat Washer Ø1/4" x 19mm \*  
x12 Rondelle de plate Ø1/4 " x 19mm  
x12 Arandela plana Ø1/4 " x 19mm



(L)

x2 Flat Washer Ø1/4" x 16mm \*  
x2 Rondelle de plate Ø1/4 " x 16mm  
x2 Arandela plana Ø1/4 " x 16mm

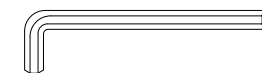

(M)

x1 Allen Key 4mm \*  
x1 Clé hexagonale 4mm  
x1 Llave allen 4mm

\* Replaceable Part

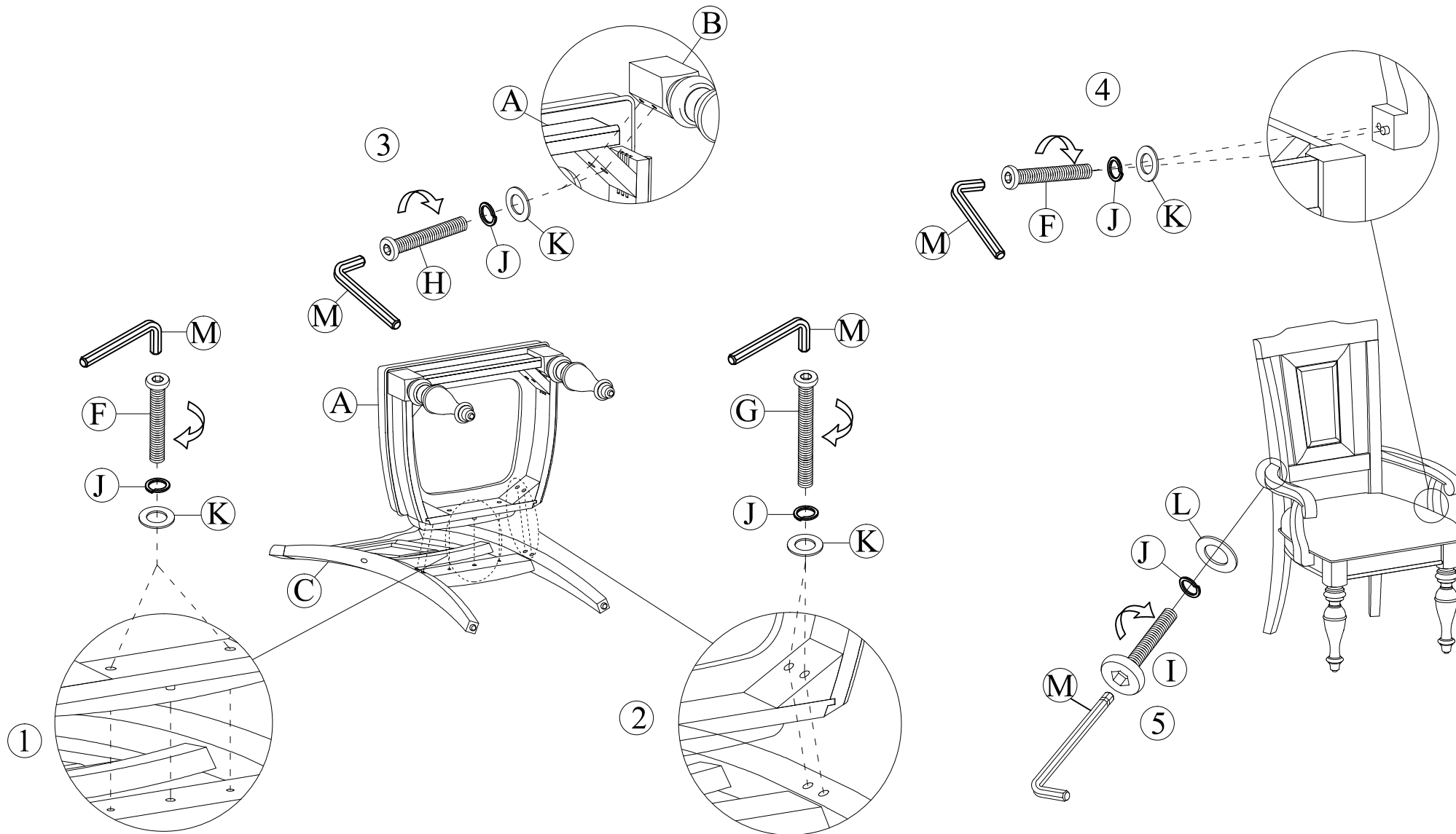

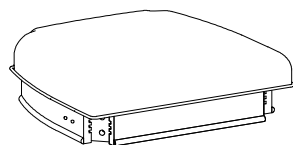
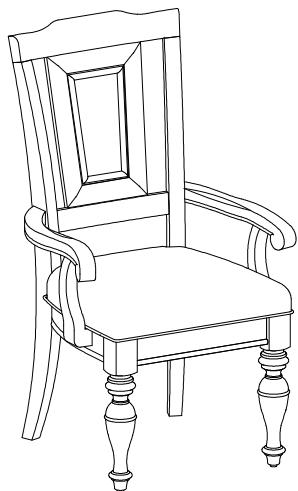

x1 RP351261-CUS  
Chair Cushion \*  
Coussin de chaise  
Cojín de silla



x2 RP351260-LEGF  
Front Leg \*  
Patte avant  
Pata delantera



x1 RP351261-ARML  
Left Arm \*  
Accoudoir gauche  
Brazo izquierdo

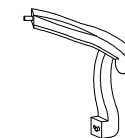

x1 RP351261-ARMR  
Right Arm \*  
Accoudoir droit  
Brazo derecho

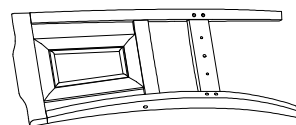

x1 RP351261-BACK  
Chair Back \*  
Dossier de chaise  
Respaldo de silla

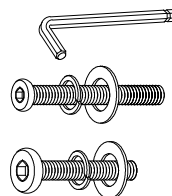

x1 RP351-261-HWKIT  
Hardware Kit \*  
Kit de matériel  
Kit de hardware



x4 RC-BR-NAIL  
Small Plastic Nail \*  
Clou en plastique  
Clavo de plástico

\* Replaceable Part