

# USER'S MANUAL

## 619UAB

BLUETOOTH®-ENABLED

MP3-COMPATIBLE DIGITAL MEDIA  
AM/FM RECEIVER



**BOSS**<sup>®</sup>  
AUDIO SYSTEMS

# CONTENTS

---

Precautions.....	1
Lithium Battery Cell Warnings .....	1
Use Cautions .....	1
Installation .....	2
Installation Procedures.....	2
Installation Opening.....	2
Wiring Connections.....	3
Uninstall the Main Unit .....	3
Control Panel Button Locations .....	4
Operation .....	4
Power / SRC .....	4
Adjust Menu Options (SRC) .....	4
Change the Source (SRC) .....	4
Store/Recall Preset Stations (1 - 6).....	4
Play/Pause .....	4
Next/Previous Track.....	5
Fast Forward/Backward .....	5
Set the Clock (CLK) .....	5
Insert SD Card .....	5
Adjust Volume (VOL) .....	5
Switch Between US and EU Frequency.....	5
Manual Tuning ( << / >> ) .....	5
Auto Seek Tuning ( << / >> ).....	5
Change Bands (BAND).....	5
Automatic Music Search (AMS) .....	5
Track Search.....	6
Track/Folder Navigation .....	6
Mute .....	6
Insert USB .....	6
AUX In Jack .....	6
Release Panel .....	6
Reset System (RESET) .....	6
Bluetooth Operation.....	7
Pair and Connect .....	7
Make a Call.....	7
Redial Last Dialed Number .....	7
Answer a Call.....	7
End a Call .....	7
Switch Audio Between Car and Phone .....	7
Adjust Talk Volume.....	7
Bluetooth Music (A2DP).....	7
Remote Control .....	8
Remove Insulating Sheet .....	8
Button Names and Locations.....	8
Troubleshooting.....	9
Specifications .....	10

# PRECAUTIONS

---

## Lithium Battery Cell Warnings

- Cell leakage may cause damage to the remote control.
- Do not throw cells into fire, as this may cause an explosion.
- Keep battery cells out of reach of children.

## Use cautions

- To reduce the risk of fire, electric shock, and annoying interference, do not repair yourself. Please refer serving to qualified person.
- Some MP3/WMA files may not be playable.
- Keep lower volumes to concentrate on traffic and road conditions for safety driving.
- If users' car is under sunlight for sometime, please lower the temperature inside the car then start the player operation.
- If the battery is disconnected or discharged or changed, the preset memory will be erased and must be reprogrammed.
- Installation of unit is better at a horizontal position, or if it is at an angle, it may be not working at its best situation.
- Never use force or grip the display and the buttons tightly when removing or attaching.
- Be sure to lower the volume before switching off the unit or the ignition key.

# INSTALLATION

## Installation Procedures

First complete the electrical connections and then check for correctness.

## Installation Opening

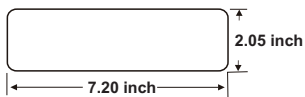

This unit can be installed in any dashboard  
Having an opening as shown above .

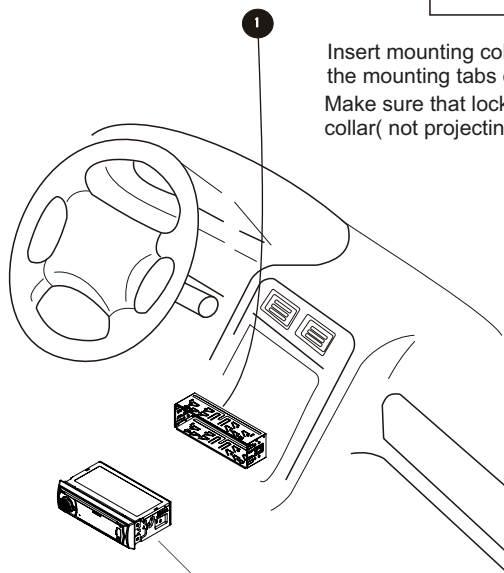
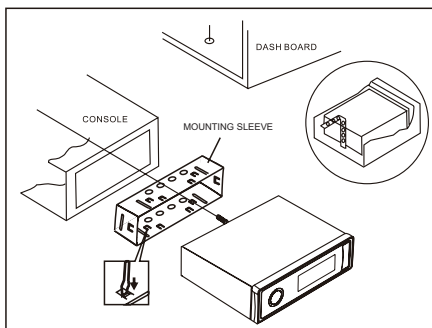

Insert mounting collar into the dashboard and bend the mounting tabs out with a screwdriver.  
Make sure that lock lever(\*) is flush with the mounting collar( not projecting outward).

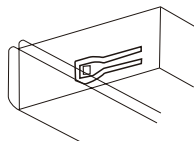

2 Secure the rear of the unit.  
After fixing mounting bolt and power connector, fix the rear of the unit to the car body by bubble cushion.

# INSTALLATION(CONT.)



- Only use speakers with 4 ohms impedance.
- Do not attach the control panel to the chassis before wiring is complete.
- The maximum current of the auto antenna is 200mA.

## Wiring Connections

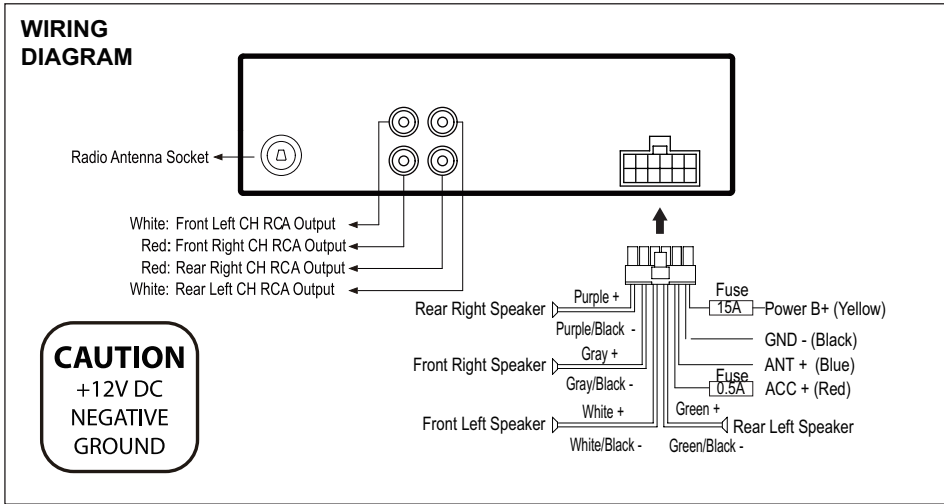

## Uninstall the Main Unit

1. Remove the metal strap from the main unit.
2. Remove the plastic trim out from the main unit.
3. Insert a bracket key into the left and right side of the main unit and draw the unit out of the mounting sleeve.

# CONTROL PANEL BUTTON LOCATIONS

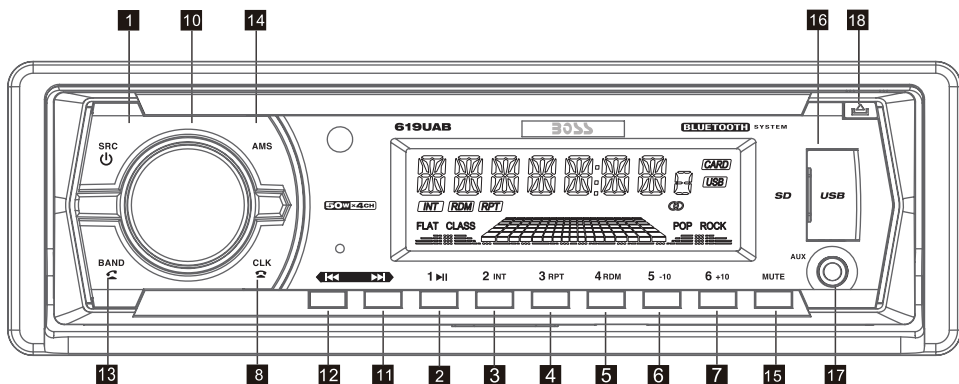

## REMOVE PANEL

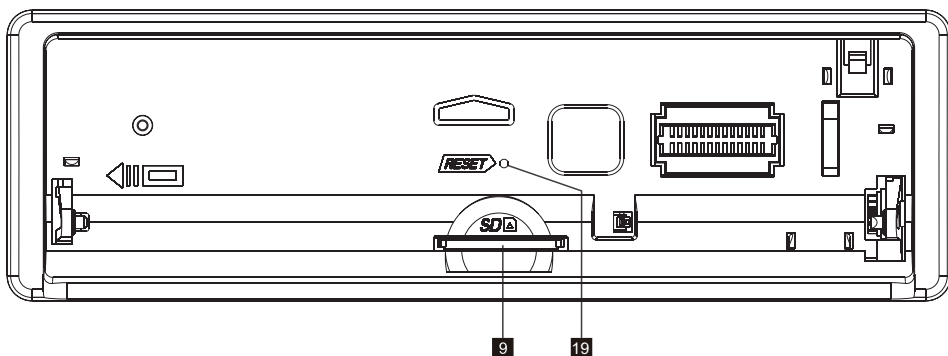

## OPERATION

### 1.PWR/SRC

Press the POWER button to turn on the unit, and long press it again to turn off the unit. When the unit turns on, short press POWER/SRC button to switch the unit between RADIO, USB&CARD, BT, AUX IN, modes (if there are USB and SD card inside the unit).

1/. If there is no USB & SD card, then it will be only radio, Aux and BT. When the user inserts a USB flash drive or SD Card, their respective logos will illuminate on the display.

### 2-7.(button 1 to 6) PRESET MEMORY BUTTONS In Radio mode

To memorize the frequency, press one of the six preset buttons (1-6) hold for more 2"S, the frequency is successfully stored.

Therefore there are FM1, FM2, FM3, AM1 & AM2, each band can store 6 stations, so total 30 stations can be stored.

To recall the preset memory station, press one of the preset buttons (1-6) plus the BND button for FM1, FM2, FM3, AM1 & AM2.

# OPERATION

---

During USB or SD card mode, press '5/-10' button to go backward 10 tracks.  
Press '6/+10' button to jump forward 10 tracks.  
During USB or SD card mode, long press '5/-10' button to go back 1 folder.  
Long press '6/+10' button to go up 1 folder. You can repeat this function depending on the number of folders. This button will have no function if the USB or SD card has no folders.

## 8. CLK

Press the CLK button once to display the real time, With time appearing on the display. Press and hold CLK button for more than 2 seconds until the time flashes. You can adjust the HOUR by pressing the >>| and |<< button respectively; then briefly the CLK button to flash the minute, and pressing the >>| and |<< button to adjust the minute.

During Bluetooth mode, the clock can not be adjusted.

## 9. SD CARD SLOT

Press the  button to flip down the front panel. Remove the front panel to gain access to the SD card slot. Insert an SD card, then attach and close the front panel. Switch to SD mode when you wish to begin SD card playback.

To remove the SD card from the unit, press the  button to flip down and remove the front panel, then push the SD card with your finger nail, the SD card will be ejected.

## 10. VOLUME adjustment

In the radio mode, rotate the volume knob to increase or decrease the volume level of the sound output. Press the volume knob, it will be switching the sequence as follows:

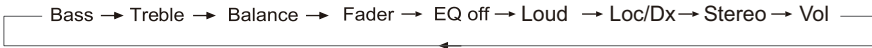

In the USB or SD card mode, press the volume knob to enter the EQ function that the audio mode in the following order: EQ OFF → FLAT → POP → ROCK → CLASS

At the radio status, press and hold the VOL button to enter switch state of the US(USA) and EU (EUROPE) frequency, then rotate the VOL knob to select US frequency or EU frequency, after selecting US or EU frequency, the system will switch to the selected frequency 3 seconds later.

## 11.FF(>>|) & 12.FB(|<<) / Manual Tuning

In the radio mode, long press the FF(>>|) or FB(|<<) button for more than 2 seconds, the unit will search the next or previous frequency step by step.

Short press the FF(>>|) or FB(|<<) button, the automatic search will start, it will search upward or downward for the strong signal radio station within the current band. The auto searching will stop until find a station.

## 13.BND

In radio mode, press the BND button repeatedly to select the one of the radio band : FM 1, FM 2, FM 3, AM1, AM2 in a cycle sequence. When you select a band, the word F1、 F2、 F3 for FM band, and A1、 A2 for AM band will be shown on the LCD display.

## 14.AMS

Press the AMS button for several seconds, the radio searches from the current frequency and check the signal strength until one cycle search is finished. And then the 6 strongest stations will be stored into the corresponding preset number within the current band. Short press the AMS button to scan each preset station in each band.

# OPERATION

---

During USB or SD playback, short press the AMS button to enter track search mode, then rotate the VOL knob to track forward or backward; if no any operation in 5 seconds, it will play the current track.

## 15. MUTE

Short press the MUTE button to turn MUTE ON/OFF, when it is on, the MUTE will be on the LCD and no sound output. When short press again it will be cancelled.

## 16. USB PORT

## 17. AUX IN JACK

## 18.

If you want to insert or remove the SD, reset the unit, remove the front panel from the head unit, press the  button to flip down the front panel.

## 19. RESET

To reset all parameters to factory default values. Press the  button to flip down the control panel from the head unit and remove the control panel, then use a subject with a sharp point end to thrush the RESET hole.



# BLUETOOTH OPERATION

---

## Pair and Connect

Prior to using the Bluetooth device as a handsfree system for a Bluetooth-enabled mobile phone for the first time, you must pair and connect the two devices as follows:

1. In any mode, prior to pairing and connecting, the BT logo flashes in the LCD indicating that no device is connected. To begin pairing, enable BT mode on your mobile phone.
2. When the phone finds the car audio system, the BOSS AUDIO name will be displayed.
3. Choose the BOSS AUDIO from the device list to pair and connect with the car audio system. Upon confirming, the BT logo will stop flashing.
4. When pairing is complete, the mobile phone audio will automatically transfer to the car audio system whenever a call is made or received, or when the mobile phone plays music.

## Make a Call

To make a call, dial the call directly from the paired mobile phone.

## Redial Last Dialed Number

Press and hold the **↶** button on the control panel to redial the last dialed phone number.

## Answer a Call

- When the mobile phone is called, the incoming telephone number displays in the LCD.
- To receive the call, press the **↶** button on the control panel.
- To reject the call, press the **↷** button on the control panel.

## End a Call

To end an active call, press the **↷** button.

## Switch Audio Between Car and Phone

During a call, press the **VOL** knob/button to switch the audio source from the car audio system back to your mobile phone.

## Adjust Talk Volume



- During a call, use **VOL** knob or **VOL +** and **VOL -** buttons to adjust the volume level.
- Use the **MUTE** button to mute sound.

## Bluetooth Music (A2DP)

1. Press the **⏪/SRC** button to enter BT mode and display media in the LCD.
2. When a mobile device is paired, music played through that device will automatically be heard through the car audio system.
3. Press the **>>|** or **|<<** button to play the next or previous song/file on the mobile phone.
4. Press the **>||** button to pause or resume music playback.

# REMOTE CONTROL

## Button Names and Locations

1. Power button
2. BAND or  button
3. >|| or 1 button
4. + 10 or 6 button
5. INT (intro) or 2 button
6. MUTE or DEL button
7. - 10 or 5 button
8. RPT (repeat) or 3 button
9. AMS (automatic music search) or 9 button
10. LOUD (loudness) or 8 button
11. CLK (clock) or  button
12. VOL (volume) button
13. SEL (select) button
14. PREV (previous) button
15. RDM (random) or 4 button
16. ST (stereo) or 7 button
17. NEXT button
18. SRC (source) or \* button
19. EQ (Equalizer) or 0 button
20. LOC (local) # button

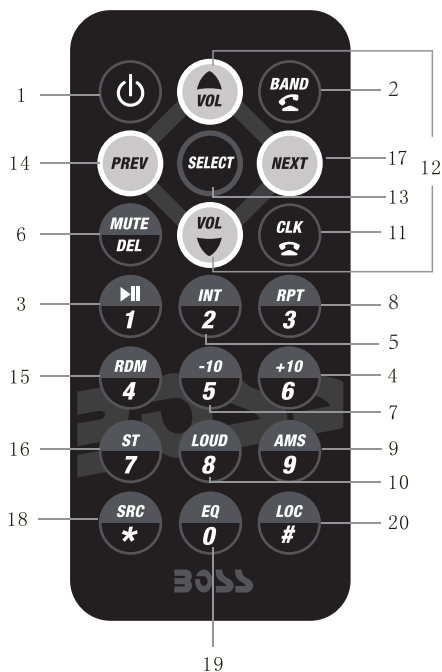

Note: To operate remote, pull out the plastic from battery compartment at back of remote. Then point remote at unit and start.

# TROUBLESHOOTING

---

If you suspect something is wrong immediately switch power off. Do not use the unit in abnormal condition, for example without sound, or with smoke or foul smell, can cause fire or electric shock. Immediately stop using it and call the store where you purchased it. Never try to repair the unit yourself because it is dangerous to do so.

## ■ General

No power or  
no sound

Car's engine switch is not on. Turn your car's key to ACC or ON.  
Cable is not correctly connected. Check connection.  
Fuse is burnt. Replace fuse. Check volume or mute on/off.

## ■ Radio

A lot of static in  
broadcast

Station or signal is too weak.  
Select other stations of stronger signal level.

Preset station  
is reset

Battery cable is not correctly connected.  
Connect the battery cable to the terminal that is always live.

## ■ USB / SD

USB or SD card  
is connecting but  
No Sound

USB or SD card connection is not good.  
Take it out and insert again.  
USB or SD card is damaged or no music file inside.  
Change to another USB or SD card, or record music inside it.

# SPECIFICATIONS

---

## General

Power supply Requirement :	DC 12V
Maximum power output :	50W X 4CH
Speaker impedance :	4 - 8 Ohm
Unit Dimensions(WxHxD) :	7.0 X 2.0 X 3.8 inch
Weight :	1.54 Lb (0.7 kg)
Fuse :	15 A

## RADIO

### FM

Frequency Range USA / EUROPE:	87.5 MHz - 107.9 MHz / 87.5 MHz - 108.0MHz
Channel step:	200 KHz / 50 KHz

### AM

Frequency Range USA / EUROPE:	530 KHz - 1710 KHz / 522-1620 KHz
Channel step:	10 KHz / 9 KHz

## USB/Card

Usable Audio Formats .....	MP3/WMA
Pre-amp Output .....	Front and Rear
Frequency Response .....	20 Hz - 20 KHz
S/N Ratio .....	60dB

## BT

BT Profile supports .....	Headset, Handsfree and A2DP & AVRCP profiles
Range of frequency .....	2.4GHz spectrum

# USER'S MANUAL

619UAB

BLUETOOTH®-ENABLED | MP3-COMPATIBLE DIGITAL MEDIA AM/FM RECEIVER



BOSS Audio Systems

3451 Lunar Court • Oxnard, CA 93030

[www.bossaudio.com](http://www.bossaudio.com) | 800.999.1236

tech support: [www.bossaudio.com/support](http://www.bossaudio.com/support)



0314

iPod® / iPhone® are trademarks of Apple, Inc. registered in the U.S. and other countries.  
BOSS Audio Systems is not affiliated with Apple, Inc.