

SIDES	BOTTOM
Material: Steel-0.0625"-G60 Galvanized	

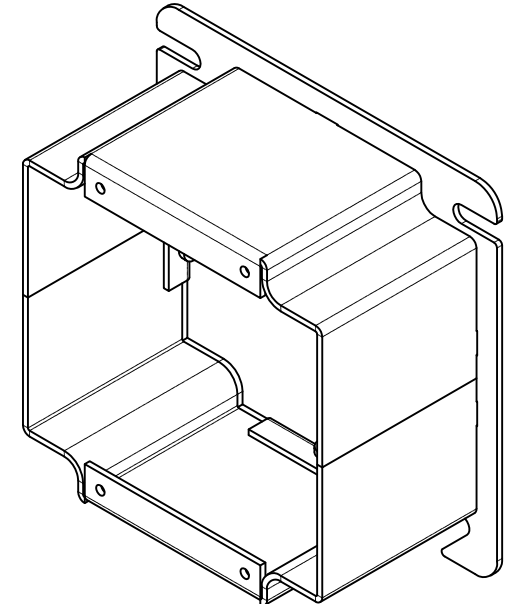
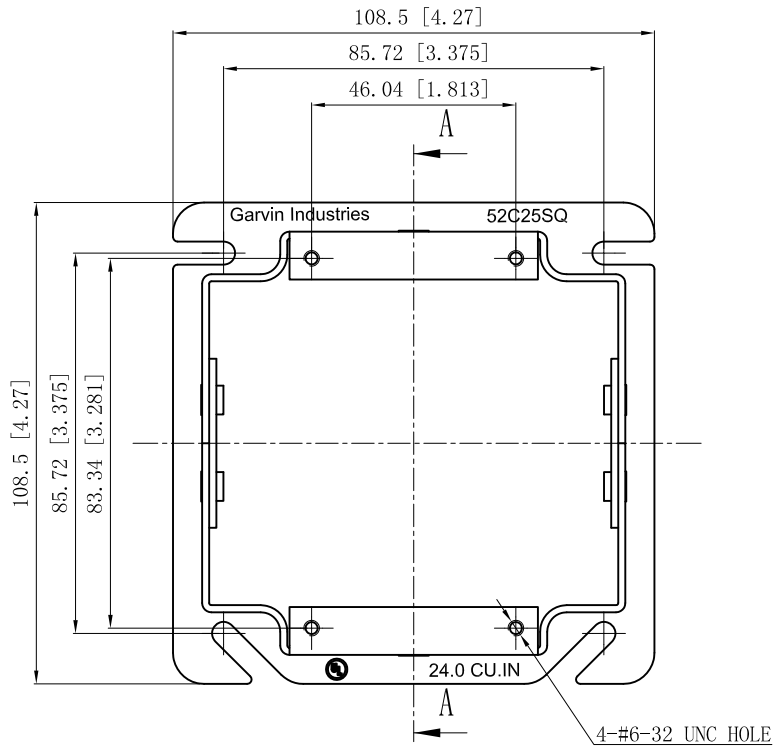
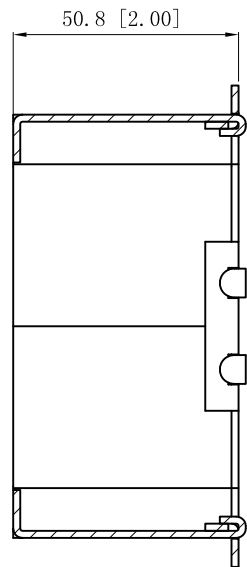
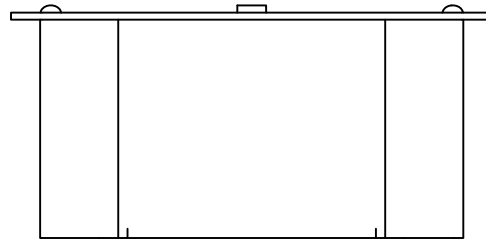

CUTAWAY VIEW A-A

This data sheet is for reference only .GARVIN INDUSTRIES reserves the right to make changes to the design without prior notice.

DESCRIPTION
TRADE REFERENCE TERMS

STANDARD PACKING
25 PCS

GARVIN INDUSTRIES		
TITLE 4" SQUARE TWO-GANG DEVICE TILE COVERS		
SIZE A4	DWG NO. 52C25SQ	REV A
DATA SHEET		