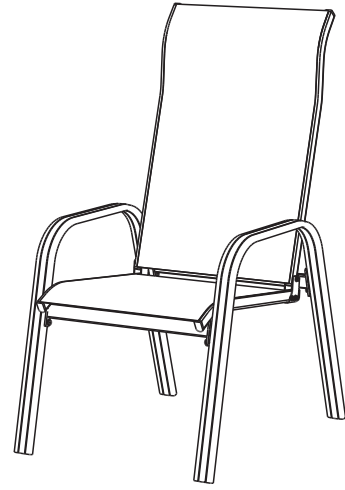
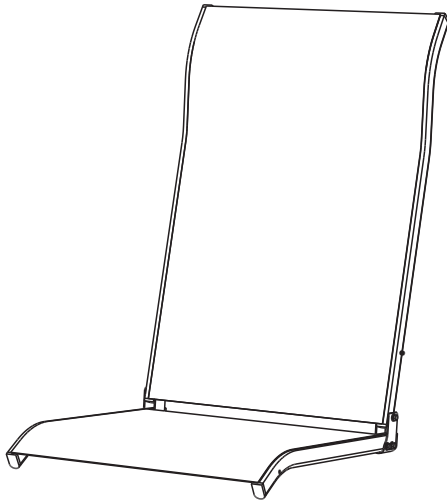

Arm Chair**IMPORTANT**

Carefully remove all the parts from the carton and place them individually on a soft cloth to prevent scratches or other damage.

Carefully and strictly follow these assembly instructions to ensure a completed product as designed.

This product is made of aluminum. Do not use power tools above 8 volts to assemble and only tighten bolts until snug. Over tightening can damage the aluminum.

**Part List**

A.
Seat
1 pc.

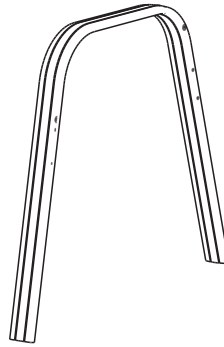

B.
Side
1 pc.

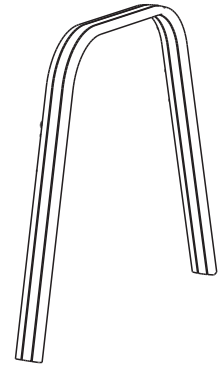

C.
Side
1 pc.

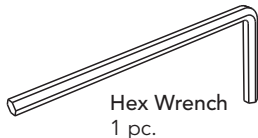

D.
Stretcher
2 pcs.

Hardware List

Hex Wrench
1 pc.

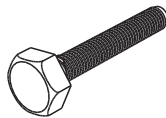

M6x35
Bolt
4 pcs. (+1 extra)



Spring Washer
4 pcs. (+1 extra)



Flat Washer
4 pcs. (+1 extra)



Small Hex Wrench
1 pc.

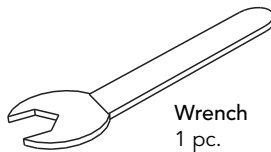

Wrench
1 pc.

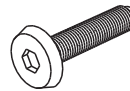

M6x18
Head Cap Bolt
8 pcs. (+1 extra)



Cap
16 pcs. (+1 extra)

Assembly Instructions 2/3

IMPORTANT

- Use a soft cloth between these parts and the floor.
- Do not use power tools above 8 volts to assemble.
- Do not tighten all the bolts until each part is properly assembled.
- Keep Hex Wrench and Wrench as the bolts may need to be tightened in the future.

STEP 1

Attach Stretchers (D) to Side (B) with Head Cap Bolts, tightening bolts only halfway. (See Figure 1)

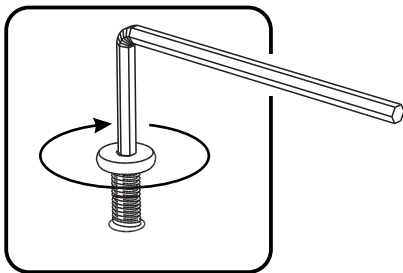

Figure 1

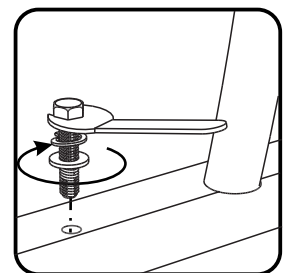
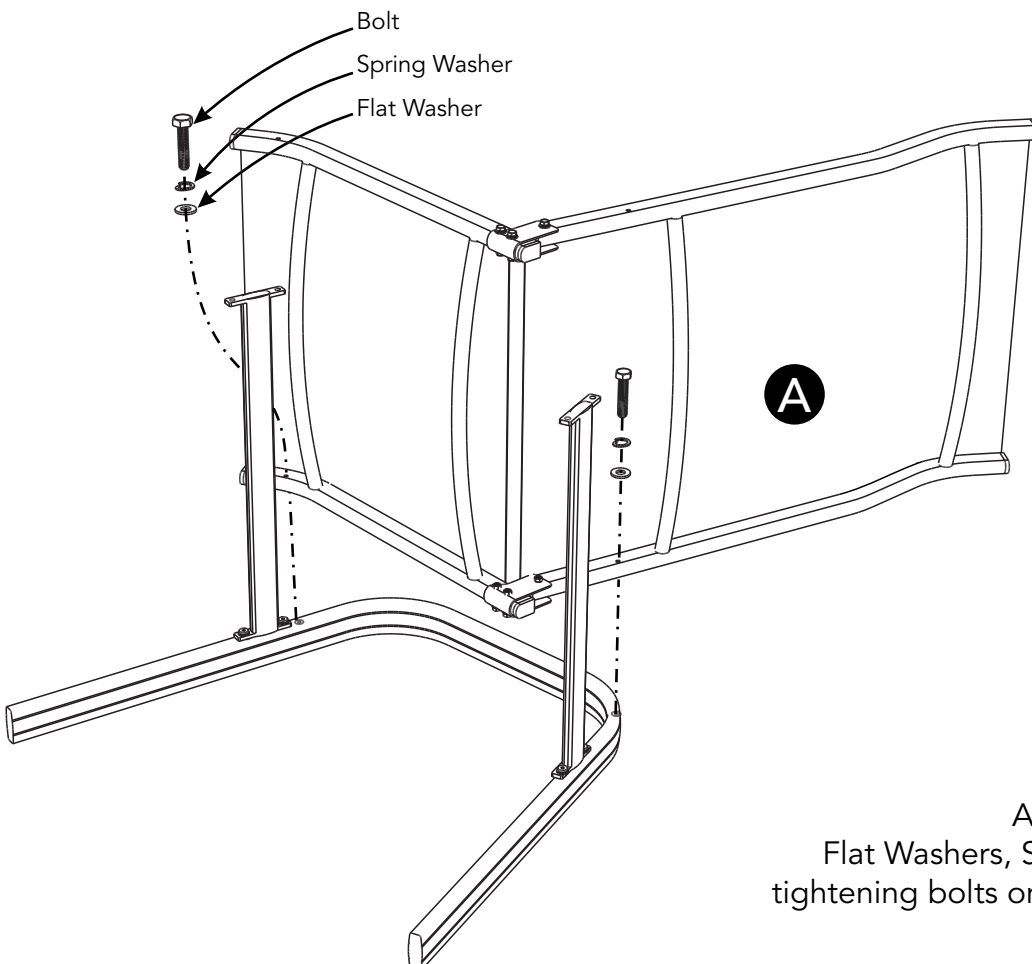
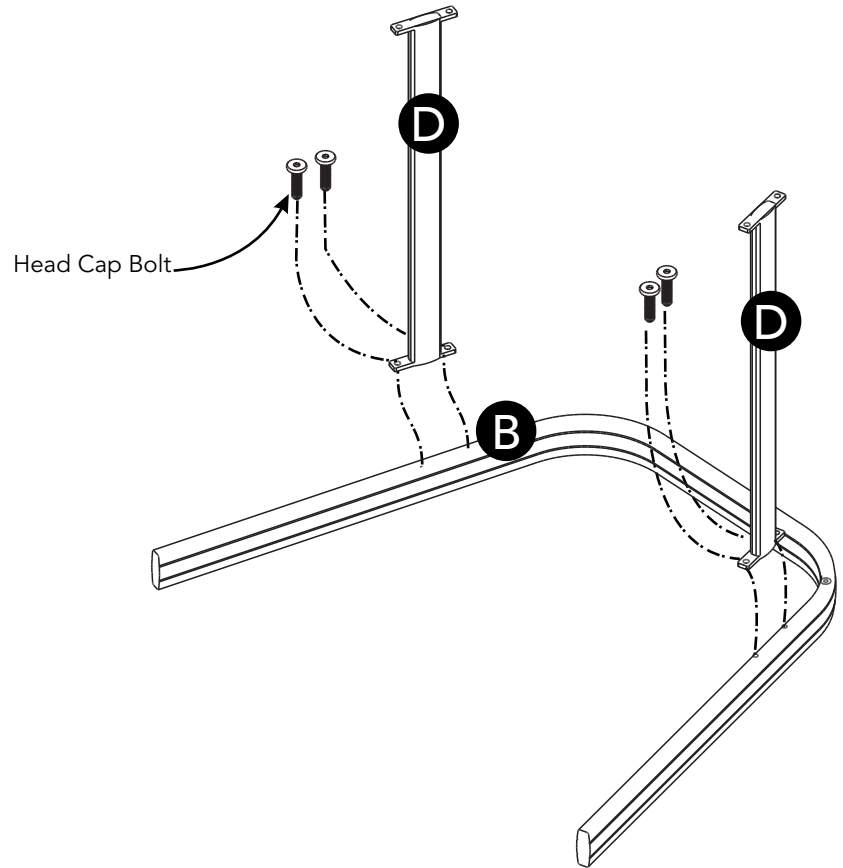

Figure 2

STEP 2

Attach Seat (A) to unit with Flat Washers, Spring Washers and Bolts, tightening bolts only halfway. (See Figure 2)

Assembly Instructions 3/3

STEP 3

Attach Side (C) to unit with Head Cap Bolts, Bolts, Spring Washers and Flat Washers, tightening bolts only halfway.

Tighten all bolts used in Steps 1, 2 and 3.

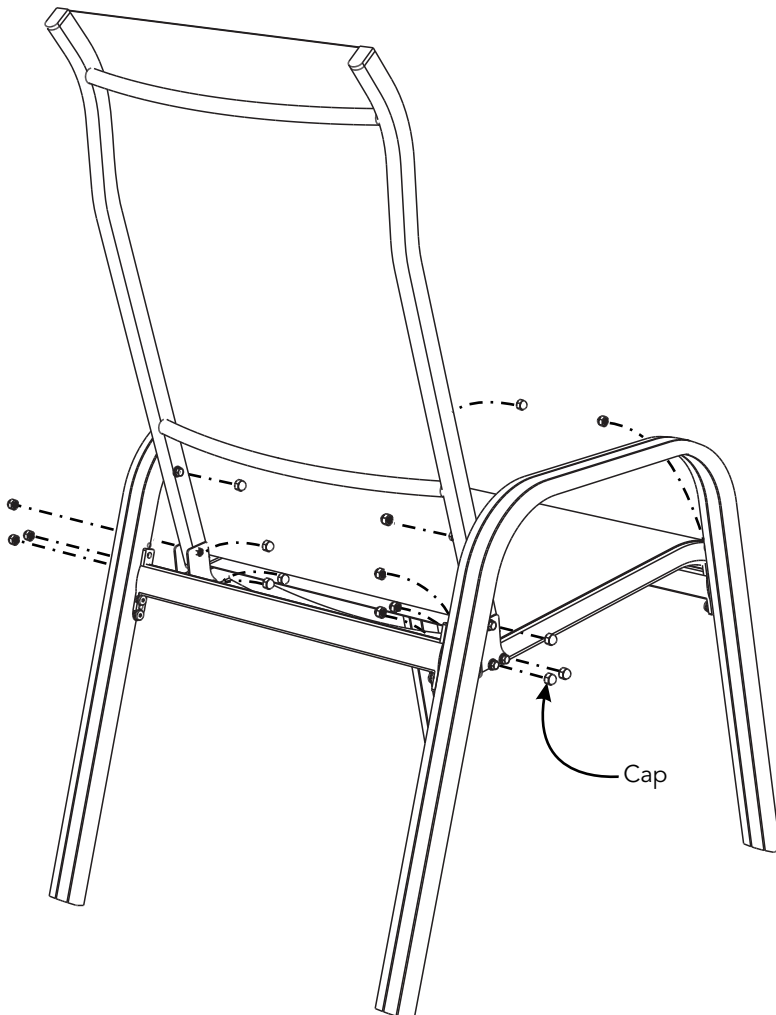
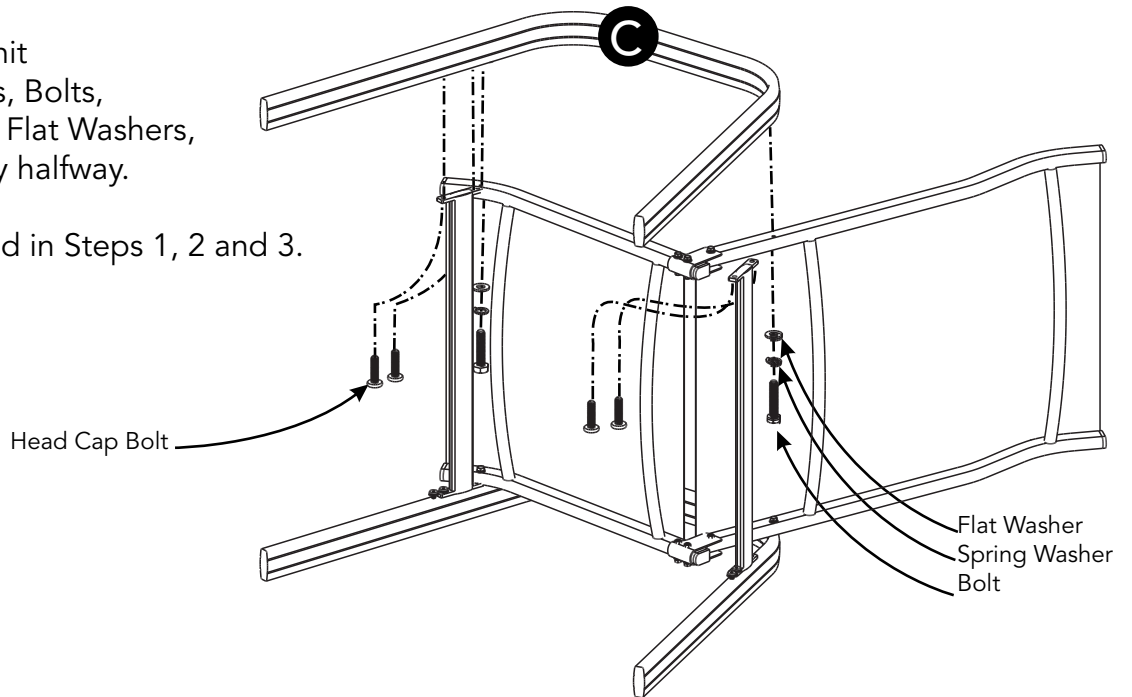

STEP 4

Turn unit to its upright position.

Cover all bolts with Caps.
(See Figure 3)

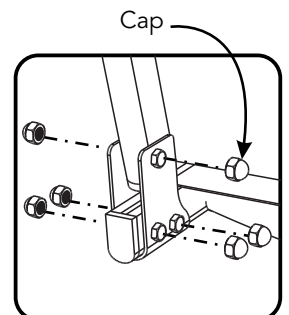

Figure 3

CARE INSTRUCTIONS

NEVER

allow liquids to remain on furniture.
Absorption causes parts to warp
and split and finishes to delaminate.

NEVER

use glass cleaners on
finished furniture. Ammonia
chemically attacks the finish.



Do not use power tools
above 8 volts to assemble.

**PREVENT
CRACKING**

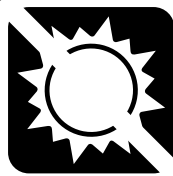

Do not place
in direct sunlight.

**PREVENT
FADING**



Do not write
directly on surface.

**PREVENT
MARKING**



Do not place hot
objects on surface.

**PREVENT
FINISH DAMAGE**

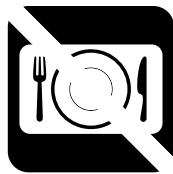

Do not use rubber
based placemats.

**PREVENT
DISCOLORING**



Do not use commercial
waxes and polishes.

**PREVENT
YELLOWING**

CLEAN

with a soft cloth moistened
in lukewarm soap and water.
Buff with a dry clean cloth.



homestyles will provide replacements free of charge for missing or damaged parts within 2 years of purchase. Digital images of the defective parts may be required. If the product was not purchased from an authorized retailer, **homestyles** is under no obligation to provide replacement parts. Parts are not available for fully assembled items nor are parts available for sale. Replacements for missing or damaged parts may be requested via contact info below.

homestyles Customer Service: www.homestylesfurniture.com,
servicedesk@homestylesfurniture.com, 888-680-7460