

43 PIECE VARIABLE SPEED ROTARY TOOL

Item Number W50031

OWNER'S MANUAL



▲WARNING

It is the owner and/or operators' responsibility to study all WARNINGS, operating, and maintenance instructions contained on the product label and instruction manual prior to operation of this product. The owner/operator shall retain product instructions for future reference.

The owner and/or operator are responsible for maintenance, maintaining all decals or warning labels and while in use, maintaining the unit in good working order. If the owner and/or operator are not fluent in English, the product warnings and instructions shall be read and discussed with the operators' native language by the purchaser/owner or his designee. Make sure that the operator comprehends its contents. Safety information shall be emphasized and understood prior to usage. The product shall be inspected per the operating instructions.

Users of this product must fully understand these instructions. Each person operating this product must also be of sound mind and body and must not be under the influence of any substance that might impair their vision, dexterity or judgment.

Protect yourself and others by observing all safety information.

Failure to comply with instructions could result in personal injury and/or property damage! If you encounter any problems or difficulties, please contact our customer service department at: 1-800-426-1262 between 6:30 a.m. and 4:30 p.m. Pacific time.

PT
Performance Tool

Performance Tool®

SPECIFICATIONS

Input	120 Volt ~ 60Hz	Shaft capacity	1/8 in.
Current.....	1.0 Amp	Collet Sizes.....	3/32 & 1/8 in.
No Load Speed	8,000 - 30,000 RPM		

Specifications are subject to change without notice.

SAFETY GUIDELINES / DEFINITIONS

This instruction manual is intended for your benefit. Please read and follow the safety, installation, maintenance and troubleshooting steps described within to ensure your safety and satisfaction. The contents of this instruction manual are based upon the latest product information available at the time of publication. The manufacturer reserves the right to make product changes at any time without notice.

▲ WARNING: Read and understand this entire instruction manual before attempting to assemble, install, operate or maintain this product. Failure to comply with the instructions may result in serious personal injury and/or property damage!

The following signal words are used to emphasize safety warnings that must be followed when using this product:

▲ DANGER: Indicates an imminently hazardous situation that, if not avoided, WILL result in death or serious injury.

▲ WARNING: Indicates a potentially hazardous situation that, if not avoided, COULD result in death or serious injury.

▲ CAUTION: Indicates a potentially hazardous situation that, if not avoided, MAY result in minor or moderate injury.

▲ NOTICE: Indicates important information, which if not followed, MAY cause damage to equipment.

UNPACKING AND INSPECTION

After opening the carton, unpack your new product and related parts & accessories. Please inspect it carefully for any damage that may have occurred during transit. Please check it against the photograph on carton. If any parts are missing, please call customer service at 1-800-426-1262 between 6 a.m. and 5 p.m. Pacific time.

▲ WARNING: DO NOT operate this product if damaged during shipment, handling or misuse. Do not operate the product until the parts have been replaced or the fault rectified. Failure to do so may result in serious personal injury or property damage. All damaged parts must be repaired or replaced as needed prior to operating this product. Check to see that all nuts, bolts and fittings are secure before putting this product into service. If you have any questions, or require assistance with damaged or missing parts, please contact our factory customer service department at: 1-800-426-1262.

Please have the serial number, model number, and date of purchase available for reference when calling.

IMPORTANT SAFETY INFORMATION

▲ WARNING: READ, UNDERSTAND AND FOLLOW ALL INSTRUCTIONS AND WARNINGS BEFORE OPERATING THIS PRODUCT. FAILURE TO DO SO MAY RESULT IN PERSONAL INJURY AND/OR PROPERTY DAMAGE AND WILL VOID WARRANTY.

1. Always use common sense and pay particular attention to all the DANGER, WARNING, CAUTION and NOTICE statements of this manual. The safety instructions provided are not intended to cover all possible conditions and practices that may occur when operating, maintaining and cleaning power tools.
2. Observe work area conditions. Do not use machines or power tools in damp or wet locations. Don't expose to rain. Keep work area well lighted. Do not use electrically powered tools in the presence of flammable gases or liquids. Do not bring combustible materials near the tools. Power tools create sparks, which may ignite the dust or fumes. Keep work area clean and well lit. Cluttered work areas invite accidents.
3. Use personal protective equipment. Wear ANSI approved safety goggles. Protective equipment such as dusk mask, non-skid safety shoes, hard hat, heavy duty work gloves or hearing protection used for appropriate conditions will reduce personal injuries.
4. Keep bystanders, children and visitors away while operating this product. Distractions can cause you to lose control.
5. Stay alert. Watch what you are doing, and use common sense when operating this product. Do not use this product while tired or under the influence of drugs, alcohol, or medication. A moment of inattention while operating this product may result in serious personal injury. Keep proper footing and balance at all times. Do not reach over or across running machines, hoses, cords, etc.

IMPORTANT SAFETY INFORMATION

- Dress properly. Do not wear loose clothing or jewelry. Keep your hair, clothing, and gloves away from moving parts. Loose clothes, jewelry or long hair can be caught in moving parts.
- Inspect before every use; do not use if parts are loose or damaged.
- Do not alter this product in any way.
- Use the right tool for the job. Do not attempt to force a small tool or attachment to do the work of a larger industrial tool. Don't use a tool whose performance is not adequate for your work. Do not modify this tool and do not use this tool for a purpose for which it was not intended.
- Some dust created by grinding, drilling, sawing, sanding, and other construction activities contains chemicals known to the State of California to cause cancer, birth defects or other reproductive harm. Some examples of these chemicals are:
 - Lead from lead-based paints.
 - Crystalline silica from bricks and cement and other masonry products, and arsenic and chromium from chemically-treated lumber.Your risk from these exposures varies, depending on how often you do this type of work. To reduce your exposure to these chemicals: work in a well ventilated area, and work with approved safety equipment, such as dust masks that are specially designed to filter out microscopic particles.
- Power tool plugs must match the outlet. Never modify the plug in any way. Do not use any adapter plugs with earthed (grounded) power tools. Unmodified plugs and matching outlets will reduce risk of electric shock.
- Double insulated tools are equipped with a polarized plug (one blade is wider than the other.) This plug will fit in a polarized outlet only one way. If the plug does not fit fully in the outlet, reverse the plug. If it still does not fit, contact a qualified electrician to install a polarized outlet. Do not change the plug in any way. Double insulation eliminates the need for the three wire grounded power cord and grounded power supply system.
- Avoid body contact with earthed or grounded surfaces such as pipes, radiators, ranges and refrigerators. There is an increased risk of electric shock if your body is earthed or grounded.
- People with electronic devices, such as pacemakers, should consult their physician(s) before using this product. Operation of electrical equipment in close proximity to a heart pacemaker could cause interference or failure of the pacemaker.
- Do not expose tool to rain or wet conditions. Water entering a power tool will increase the risk of electric shock.
- Do not abuse the cord. Never use the cord for carrying, pulling or unplugging the power tool. Keep cord away from heat, oil, sharp edges or moving parts. Damaged or entangled cords increase the risk of electric shock.
- When operating a power tool outdoors, use an extension cord suitable for outdoor use. Use of a cord suitable for outdoor use reduces the risk of electric shock.
- If operating a power tool in a damp location is unavoidable, use a ground fault circuit interrupter (GFCI) protected supply. Use of a GFCI reduces the risk of electric shock.
- Prevent accidental starting. Ensure switch is in the "OFF" position before connecting to power source and/or battery pack, picking up or carrying the tool. Carrying power tools with your finger on the switch or energizing power tools that have the switch "ON" invites accidents.
- Do not use the power tool if the switch does not turn it on and off. Any power tool that cannot be controlled with the switch is dangerous and must be repaired.
- Always maintain a firm grip on the tool with both hands. Never put your hands or feet in the cutting area. Do not grasp the tool or place your hands too close to the bit. Keep your hands well away from the bit. Never reach underneath the tool while the bit is in motion. Do not use your legs or feet to stabilize the work piece.
- Always hold the tool by its insulated gripping surfaces when cutting in areas that may contain hidden live wiring. If the bit makes contact with a live wire, the metal parts of this tool may conduct enough electricity to seriously shock the user. Contact with a "live" wire will make exposed metal parts of the tool "live" and shock the operator. Do not cut or break into existing walls or other blind areas where electrical wiring may exist. If this situation is unavoidable, disconnect all fuses or circuit breakers feeding this worksite.
- Secure the material being worked on. Never hold it in your hand or across your legs. Unstable support can cause loss of control and injury.
- Be careful not to accidentally trip the power switch when setting the tool down or picking the tool up.
- Make sure all nuts and screws are securely tightened after changing bits.
- Check to see that keys and adjusting wrenches are removed from the tool before switching the tool "ON". Keys or wrenches can flyaway at high velocity striking you or a bystander.
- Do not use the tool if it has been damaged, left outdoors in the rain, snow, wet or damp environments, or immersed in liquid.

IMPORTANT SAFETY INFORMATION

28. Disconnect the plug from the power source before making any adjustments or changing accessories. Such preventive safety measures reduce the risk of starting the power tool accidentally.
29. Keep cutting tools sharp and clean. Properly maintained cutting tools with sharp cutting edges are less likely to bind and are easier to control. Handle sharp bits with care.
30. Only use the tool, accessories and tool bits etc. in accordance with these instructions, taking into account the working conditions and the work to be performed. Use of the power tool for operations different from those intended could result in a hazardous situation.
31. Check the speed rating on all accessories. Accessories must never be run at a higher speed than they were designed to handle.
32. When using wire or bristle brushes, always wear protective gloves and a face shield. These brushes should never be run at speeds greater than 15,000 RPM.
33. Always run brushes at operating speed for a minute before using to eject loose wires and bristles. Be sure that the discharge is pointed away from you. Make sure no one is standing in front or in line with the brush.
34. Do not apply heavy pressure to wire or bristle brushes. This will only cause damage and/or personal injury. Brushes work best when applied lightly.
35. Do not use a wheel that may be damaged. If the tool or wheel is dropped, install a new wheel before continuing. Avoid bouncing and snagging the wheel as this may lead to cracking or chipping.
36. Never touch the collet or bit immediately after use.
37. Never place hands near the spinning bit.
38. Never start the tool while bit is engaged in the material.
39. Always feed the bit into the material in the same direction that the chips are thrown.
39. If the bit becomes jammed in the workpiece, turn the tool off at the switch. Once all moving parts have come to a stop, unplug the tool and work the bit free.
40. To prevent short circuits, clean the tool's vents regularly with compressed air.
41. This tool is not a dental tool. Do not use on the teeth of animals or humans.
42. Maintain power tools. Check for misalignment or binding of moving parts, breakage of parts and any other condition that may affect the power tool's operation. If damaged, have the power tool repaired before use. Many accidents are caused by poorly maintained power tools.
43. Have your power tool serviced by a qualified repair person using only identical replacement parts. This will ensure that the safety of the power tool is maintained. Follow instructions in the Maintenance section of this manual. Use of unauthorized parts or failure to follow Maintenance Instructions may create a risk of shock or injury.
44. Store idle equipment. When not in use, tools must be stored in a dry location to inhibit rust. Always lock up tools and keep out of reach of children and other untrained persons. Switch off all unused electrical tools when stored. Disconnect battery from unit. Tools are dangerous in the hands of untrained users.





CONTROLS AND COMPONENTS

1. Collet
2. Shaft Lock Button
3. Motor Brushes
4. On/off Switch
5. Hanging Hook
6. Power Cord
7. Speed Control Dial



SYMBOL DEFINITIONS

IMPORTANT: Some of the following symbols may be used on your tool. Please study them and learn their meaning. Proper interpretation of these symbols will allow you to operate the tool better and safer.

Symbol	Name	Explanation
V	Volts	Voltage (Potential)
A	Amperes	Current
Hz	Hertz	Frequency (Cycles per Second)
W	Watt	Power
Kg	Kilograms	Weight
	Alternating Current	Type of Current
	Direct Current	Type of Current
	Alternating or Direct Current	Type of Current
	Earthing Terminal	Grounding Terminal
	Class II Construction	Denotes Double Insulation
min	Minutes	Time
s	Seconds	Time
∅	Diameter	Size of Drill Bits, Grinding Wheels, etc.
n_0	No load speed	No-load Rotational Speed
.../min	Revolutions per Minute	Revolutions, Surface Speed, Strokes, etc. per Minute
1,2,3,...	Ring Selector Settings	Speed, Torque or Position Settings

CARE & MAINTENANCE

▲WARNING: Always UNPLUG the tool from the power source before inspecting, performing any maintenance or cleaning.

▲NOTICE: This Rotary Tool is lubricated before it leaves the factory. This lubrication should last for the life of the tool. No further lubrication is required.

Use only mild soap and a damp cloth to clean the tool. Never let any liquid get inside the casing. Never immerse any part of the tool in a liquid. Always keep the ventilation openings clear.

Brushes will wear with use and should be inspected periodically by qualified personnel.

Regularly clean the ventilation slots in your tool using only a soft brush or dry cloth.

Never open the Rotary Tool case. Do not attempt to repair the Rotary Tool yourself.

Opening the case will void your warranty.

OPERATION

▲WARNING: Disconnect the 'power plug from the AC power source before any assembly,' adjustments, or adding/removing accessories. Following this preventative step reduces the risk of the saw coming on accidentally and the risk of damage to the workpiece and injury to the operator. Never hold the tool near your face. Accessories like wire brushes or grinding wheels may come apart during use.

▲CAUTION: Be careful not to cover the air vents with your hand. This will cause the motor to overheat.

This rotary tool is a multipurpose power tool. It is a drill, polisher, power brush, grinder, cutter, and sander all in one. This

high-speed, low torque tool is easy to handle and accepts a wide range of accessories from polishers to router bits to wire brushes and grinding wheels. The high speed allows it to do jobs that low speed tools can't handle like engraving glass or cutting hardened steel.

▲NOTICE: Never push on the tool. The high speed and the accessory, not the pressure on the tool, do the work.

TIP: Practice by making passes on a scrap piece of material. This tool works best if you do the work in small increments, moving back and forth until you reach the desired result.

OPERATING SPEEDS

NOTE: Speed is affected by voltage changes. If the incoming voltage is reduced, it will slow the RPM of the tool, especially at the lowest setting. If the tool appears to be running slowly, increase the setting accordingly.

The operating speed will vary depending on the material and type of accessory you are using.

To find the right speed for your job, use a test piece of the material. Try various speeds until you find the one that is best for your project.

If you are doing delicate woodcarving, polishing, buffing or any use which requires a wire brush, slow speeds of 15,000 RPM or less are best. Any material, like plastic, that melts at low temperatures should also be cut at low speeds.

If you are carving, routing, shaping or cutting glass, metal or hardwoods, higher speeds are necessary. Drilling should also be done at high speed.

Softer metals, like aluminium, copper alloys, and tin may be cut at various speeds, depending on the type of cutting being done.

A lubricant like wax should be used on the cutter to keep the cut material from adhering to the cutter teeth.

If the tool is not performing the way you think it should, perhaps you are using the wrong accessory. Putting pressure on the tool will not help the performance.

ACCESSORIES

Use only accessories that are recommended by the manufacturer for your model. Accessories that may be suitable for one tool may become hazardous when used on another tool.

Always attach grounded (3-prong) extension cords to grounded (3-hole) outlets.

This product should be grounded. In the event of an electrical short circuit, grounding reduces the risk of electric shock by providing an escape wire for the electric current. This product is equipped with a cord having a grounding wire with an appropriate grounding

plug. The plug must be plugged into an outlet that is properly installed and grounded in accordance with all local codes and ordinances.

If you must use an extension cord, be sure that the gauge is large enough to carry the amount of current necessary for your power tool. If not, your tool may experience a loss of power, excessive voltage drop or overheating. The smaller the gauge number, the heavier the cord (see table below).

RECOMMENDED SIZES OF EXTENSION CORDS FOR 120 VOLT AC 60 HZ TOOLS

CURRENT RATINGS IN AMPS		CONDUCTOR SIZE IN A.W.G.			
MORE THAN	LESS THAN	25 ft.	50 ft.	100 ft.	150 ft.
0	6	18	16	16	14
6	10	18	16	14	12
10	12	16	16	14	12
12	16	14	12	NOT RECOMMENDED	

INSERTING/REMOVING ACCESSORIES

▲WARNING: Always unplug rotary tool before changing accessories, changing collets or servicing. The tool could start unexpectedly, causing serious injury.

1. Press the shaft lock button. Rotate the shaft manually until the lock engages and prevents further rotation.

▲WARNING: Do not engage lock while the rotary tool is running.

2. With the shaft lock button engaged, loosen collet counter-clockwise enough to remove the old accessory (if any) and install the new accessory, being sure to push it as far as possible into the collet.

▲NOTICE: Never force a larger diameter shank into a collet. Always match the collet nut to the shank size of the accessory to be used.

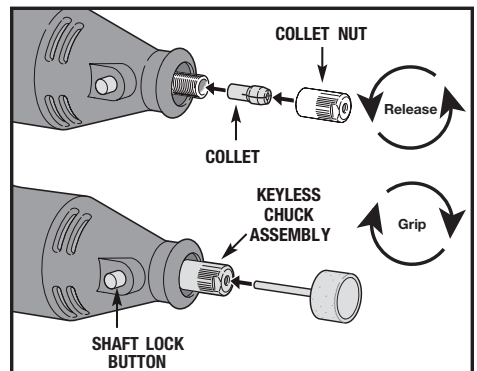

3. With the shaft lock button still engaged, tighten collet clockwise by hand to secure accessory in place.

ACCESSORIES

BALANCING

For best results, be sure to balance each accessory in the collet. Your tool's high RPM makes imbalances easily detectable as a wobble while the tool is running. To balance an accessory:

1. Stop the tool.
2. Loosen the collet nut.
3. Rotate the accessory 1/4 turn.
4. Tighten the collet.
5. Run the tool.
6. Continue adjusting as needed. You will hear and feel when the accessory is properly balanced.

CHANGING COLLET SIZES

Your rotary tool kit may have multiple collets to accommodate different accessories with varying shank sizes.

TO CHANGE A COLLET:

1. Loosen the collet nut as described above, then remove the collet nut.
2. Remove the old collet.
3. Insert the loose collet.
4. Tighten the collet nut as described above.

TYPES OF ACCESSORIES

Your rotary tool may be used with the following accessories:

BRUSHES

Wire brushes are useful for cleaning and polishing metal, while bristle brushes are suitable for cleaning softer surfaces. As with all rotary tool accessories, you should let the speed do the work without applying excessive force. Use the bristle tips only without mashing the brush against the work piece as shown in the top part of the illustration on the right.

▲WARNING: NEVER RUN BRUSHES AT SPEEDS ABOVE 15,000 RPM. The brush could eject bristles at high speed which could become embedded in your skin or which could cause other serious injury.

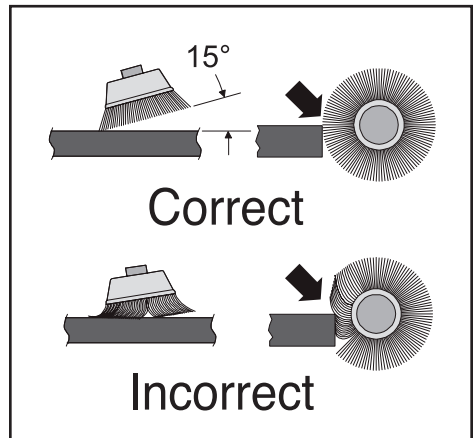

ACCESSORIES

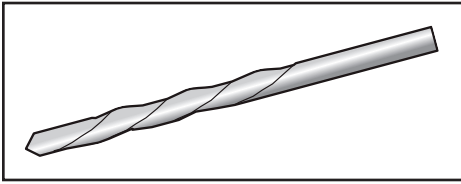

DRILL BITS

High-speed steel drill bits are suitable for most drilling applications in wood, plastic, and thin metal. For ceramics, drywall, or other specialized applications, you will need to purchase an appropriate drill bit.

SCREW SHANKS

Screw shanks are used for mounting cutting wheels, see below.

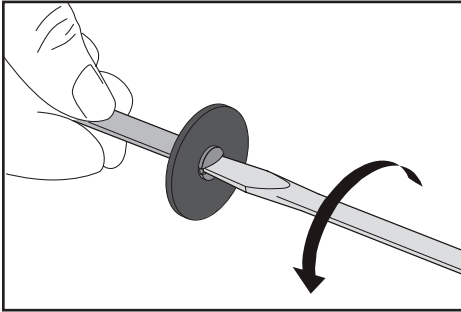

CUTTING WHEELS

To prepare a cutting wheel for use, remove the screw in the center of the shank, mount the wheel, and replace the screw.

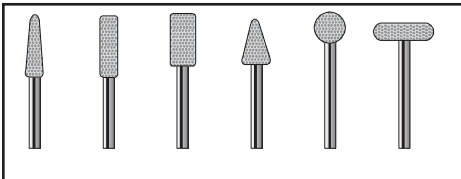

GRINDING STONES

Use these stones for smoothing hard materials such as wood, plastic, and metal. Be sure not to allow the work piece to overheat as this can cause

charring (wood), melting (plastic), or discoloration (metal). Aluminum oxide (red) accessories are best for wood, metals, and plastics, while silicon carbide (blue) accessories are best for very hard surfaces such as glass.

CUTTING BITS

Use cutting bits for shaping various materials. The smallest cutting bits are suitable for use in engraving.

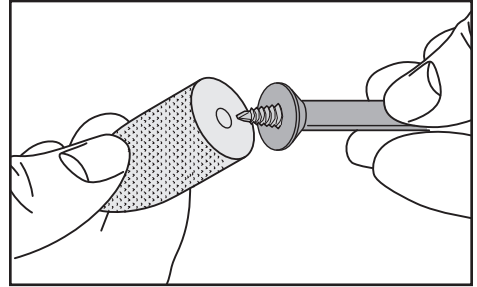

POLISHING WHEELS

These accessories are useful for removing tarnish and weathering on metal and for polishing plastics. They require a special shank with a screw tip. To prepare a polishing wheel, screw the felt onto the shank tip. Reverse to remove. Polishing grease can be used in small quantities to aid in polishing metal. Lower speeds are best for these accessories.

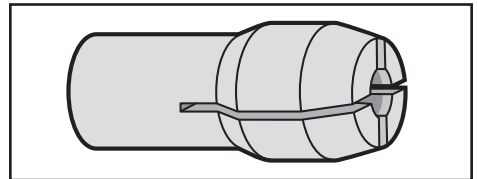

COLLETS

Various sizes are used to accommodate accessories with different-sized shanks. Refer to the section on Collet Sizes for instructions on changing the collet.

ACCESSORIES

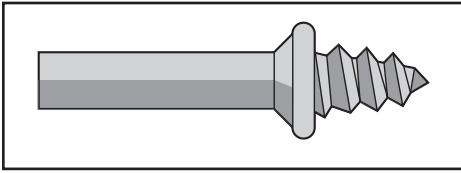

THREADED-TIP SHANKS

Threaded-tip shanks are used for felt polishing wheels. Shanks with a long threaded tip are used for pointed polishing wheels while shanks with short threaded tips are used for round felt polishing wheels. To install a felt polishing wheel, simply screw it onto the threaded shank.

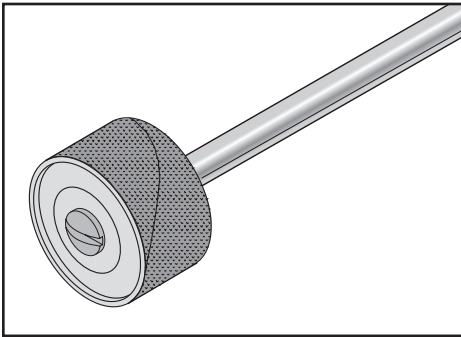

SANDING BANDS

These small drum sanders help you shape and smooth surfaces in tight places. Replace bands when they become worn. Bands come in fine grades for finish and delicate work and coarse grades for heavier work. Sanding bands work best at lower speeds. Experiment with scrap material before working on an actual project. To use a sanding band, loosen the screw in the shank, slip the band onto the shank, then tighten the screw to secure the band.

SANDING BAND SHANKS

Sanding band shanks feature an expanding core that hold disposable bands securely. To contract the core to remove or install a band, loosen the screw. Tightening the screw expands the core.

1 YEAR LIMITED WARRANTY

PERFORMANCE TOOL® extends only the following warranties, and only to original retail purchasers. These warranties give specific legal rights. Except where prohibited by local law, the law of the State of Washington governs all warranties and all exclusions and limitations of warranties and remedies. There may be other rights which vary from state to state.

PERFORMANCE TOOL® warrants the product to be free from defects in materials and workmanship under normal use and service. A defective product may be returned for a free replacement within 90 days from the date of purchase, provided that product is returned to place of purchase immediately after discovery of defect. After 90 days and up to one year from date of purchase, PERFORMANCE TOOL® will replace at no charge any parts which our examination shall disclose to be defective and under warranty. These warranties shall be valid only when a sales receipt showing the date of purchase accompanies the defective product or defective part(s) being returned. For part(s) after 90 days, please remit your request, postage prepaid to:

PERFORMANCE TOOL, P.O. Box 88259 Tukwila, WA 98138

These warranties exclude blades, bits, punches, dies, bulbs, fuses, hoses, and other consumables which must be replaced under normal use and service. These warranties shall not apply to any product or part which is used for a purpose for which it is not designed, or which has been repaired or altered in any way so as to affect adversely its performance or reliability, nor shall these warranties apply to any product or part which has been subject to misuse, neglect, accident or wear and tear incident to normal use and service.

PERFORMANCE TOOL® does not authorize any other person to make any warranty or to assume any liability in connection with its products.

Except for warranties of title and the limited express warranties set forth above, PERFORMANCE TOOL® makes no express or implied warranties of any kind with respect to its products. In particular, PERFORMANCE TOOL® makes no implied warranty of merchantability and no implied warranty of fitness for any particular purpose, except that for goods purchased primarily for personal, family or household use and not for commercial or business use, PERFORMANCE TOOL® makes an implied warranty of merchantability (and, if otherwise applicable, an implied warranty of fitness for a particular purpose), but only for the particular qualities or characteristics, and for the duration, expressly warranted above. The laws on limitation of implied warranties may differ from state to state, so the above limitations may not apply in all cases.

PERFORMANCE TOOL® shall not be liable for consequential, incidental or special damages resulting from or in any manner related to any product, or to the design, use, or any inability to use the product. The sole and exclusive remedy for a defective product or part shall be the repair, or replacement thereof as provided above. The laws on limitation of remedies or on consequential, incidental or special damages may vary from state to state, so the above limitations may not apply in all cases.