



**Extended Warranty
Sign Up**

E-1

Welcome home!

PT-SF0007

**TEAMSON HOME
38 inch Height Solar
Fountain**

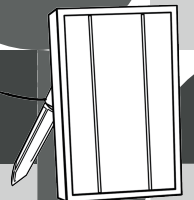
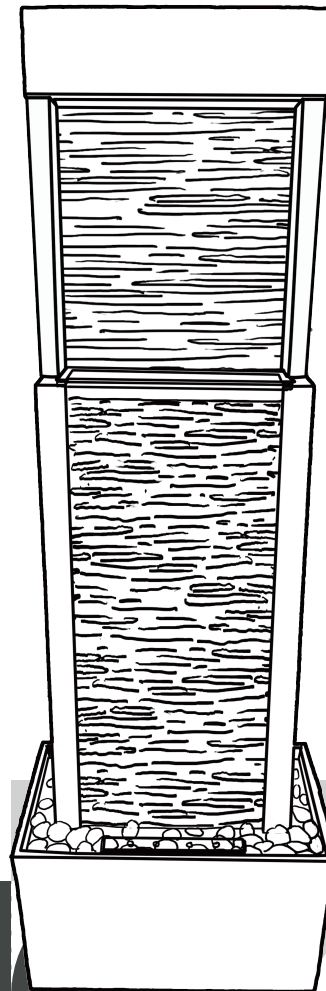

Warranty

All components are warranted by the manufacturer for a period of 30 days after the date of purchase by the original owner against defects in materials & workmanship under normal use. If it is appropriate to replace your product due to specific defects, the manufacturer will replace the purchase with the same product or a comparable product.

For specific instructions on how to obtain warranty service for your product, please contact Customer Service using the contact information provided.

Global Customer Service

USA



✉ support@teamson.com

+1(800)935-3959

Mon - Fri 10:00am ~ 2:00pm EST

EU/UK



✉ support@teamson.co.uk

+44(0)1952-916-050

Mon - Thu 9:00am ~ 5:00pm GMT

Friday 9:00am ~ 4:00pm GMT

ASIA

深圳办公室:

✉ sales_ec@teamson.com

+86(0755)8885-3558. 分机号331

Mon - Sat 9:00am ~ 5:00pm GMT+8

台北办公室:



✉ sales_ec@teamson.com

+886(2)2556-6268

Mon - Fri 9:00am ~ 5:00pm GMT+8

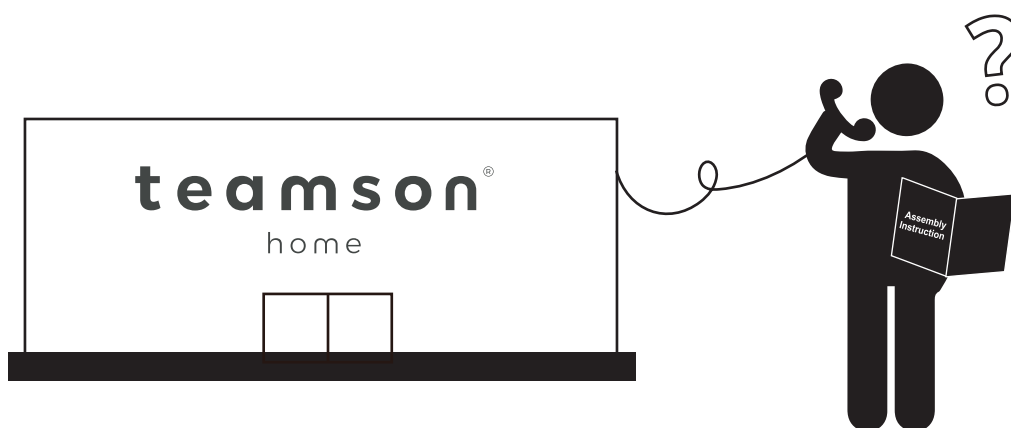
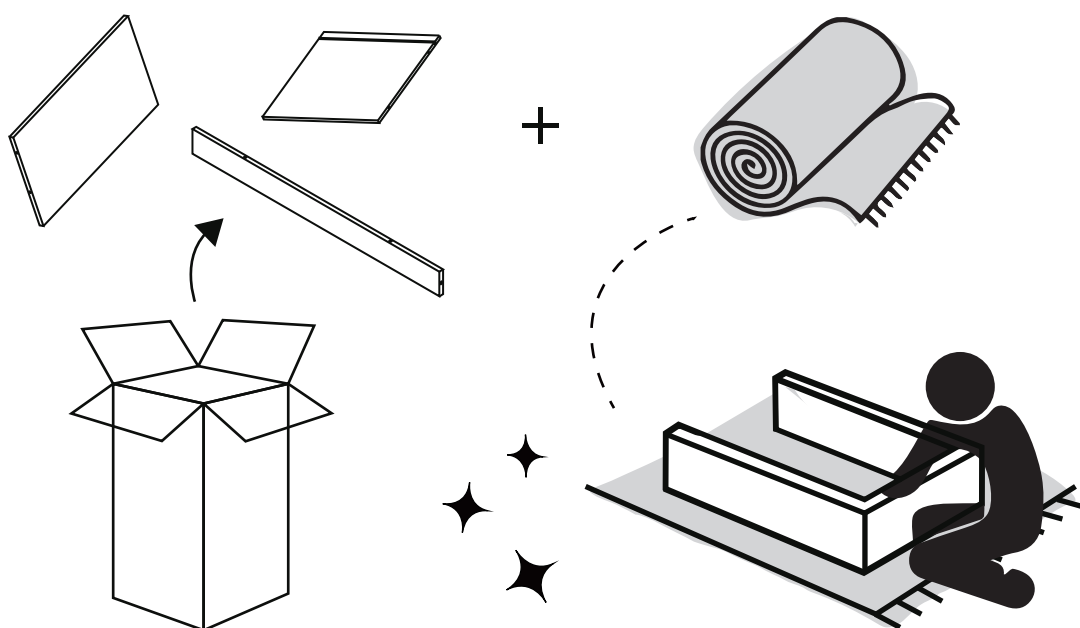
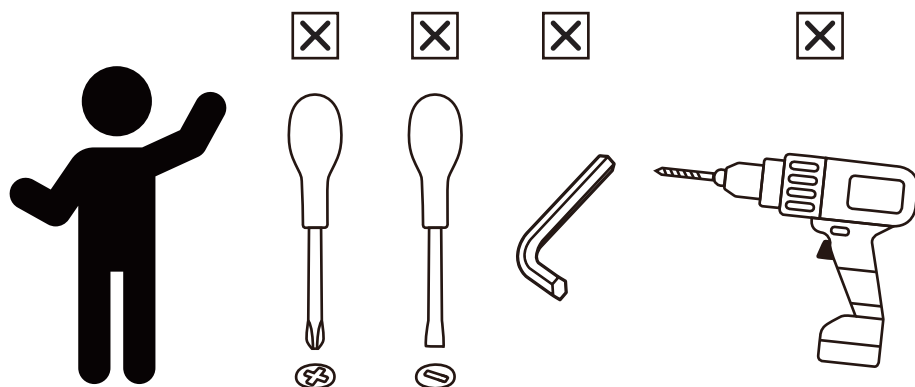

** Got questions? Please have your product code (on the first page of this instruction, e.g. PT-SF0007) and the order number ready, give us a call or email us through our customer care support! We are always ready to assist you!

Note :

1. **Charged the solar unit for at least 2days before assembly pump for using.**
2. **The LED light will work only when it's dark.If you want to test in the daytime turn the solar panel upside down and minimise exposure to sunlight.**
3. **The working time per day will be various affected by direct sunshine timing upon weather and season.**

Overview

1. The solar pump is designed for fountain, pond or outdoor use. In order to make the solar pump work, the solar panel needs to be in direct sunlight. When the sun light is strong enough, the solar pump will start to work automatically. It will stop working when the solar panel is in shadow or the sunlight is not enough. If the fountain is used in evening, the warm LEDs will give light automatically to enhance the beauty scene of the water jet.
2. This solar pump is equipped with a battery pack. Extra electricity will be stored in the battery pack and to be used when there is no enough sunlight or in night times.
3. When long time not use, please disconnect pump from solar panel set.
4. Press the button (switch) which is on the back of solar panel
Turn on: fountain will work
Turn off: It is only for power charged, pump and LED lights not work.

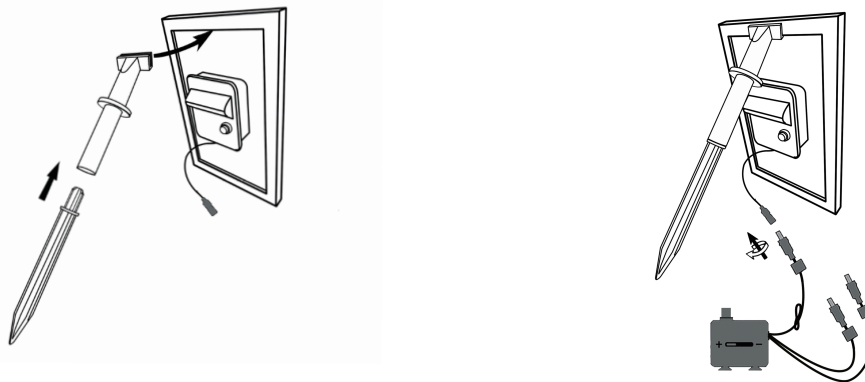

Assembling and Using Your Product

1. Unpack all components carefully. Please keep in mind that some water may splash over the rim of a bowl, do not set up the fountain on a surface which may be damaged by water.
 2. Lead the water tube and LED light cables from the bottom of the fountain top. Connect the water tube to the pump outlet on top. LED light should be connected to the LED cables on the pump while the pump power cord is connected to the solar panel. When all the parts are secured together, place the pump upright into the fountain basin before securing the fountain top on the fountain basin.
 3. Place the pebbles on top of the fountain board below.
 4. Insert the stake into the hole which is on the bottom of solar panel bracket.
 5. Make sure the solar panel gets direct sun light.
- The solar fountain is now ready for use.



Scan for assembly instructions.

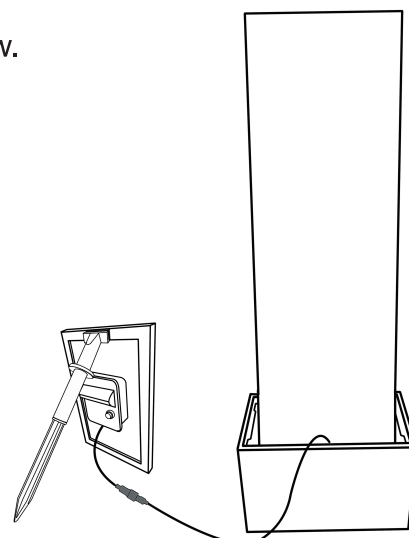

Cleaning and Maintenance

Pump: If, after a period of time, the pump starts to lose power or stops working check for the build up of sediment, scale or dirt in the pump. Remove the pump filter, the gland and rotor. Clean them by fresh water.

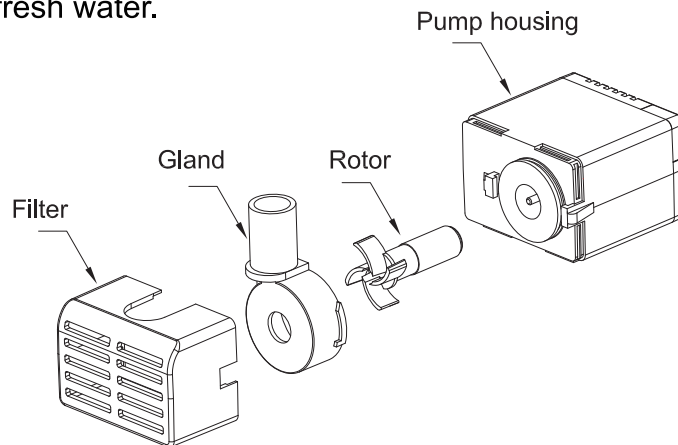

Water raining drainage hole cleaning: When finding the water raining do not fall smoothly, please take out the top water bin to clean and use a pin to clean the drainage hole.

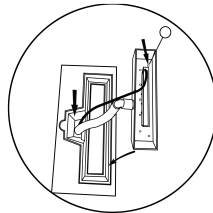

Solar Panel: The panel should be cleaned periodically with a soft tissue. Regular cleaning of the panel is advised to maintain optimum conversion of the sun's energy into direct current.

Troubleshooting Guide

1. Pump does not operate even though the solar panel is in full sunlight.
 - 1.1 No connection to the solar unit - check connection to the solar unit.
 - 1.2 Rotor is blocked -To clean the pump, remove the pump filter, the gland and rotor. Use a small brush or steam of water to remove any debris.
2. Pump does operate but there is no water running through the fountain top, check for the build up of sediment or scale in the tubes or the pump - clean the tube and the pump.





Technical Data

Solar Pannel:	6.5W
Solar Pump Operation Voltage:	9V DC
Solar Pump:	1.85W
Water Flow Max.:	250L/H
Water Lift Max.:	1.2W
LED Light (Pre-assembled):	2 LED Yellow Light
Lithium Battery:	2×3.7V/2000mAH
Pump Waterproof Rate:	IPX8
Panel Waterproof Rate:	IP64

Caution

- 3.1 Do not strike the solar panel.
- 3.2 Do not let the pump run dry for long time. Always disconnect pump from solar when long time not use.
- 3.3 Do not lift the pump by the power cord.
- 3.4 Operate in freshwater only.

Pump performance in different weather condition:

Weather	Performance of the pump	Charging of the battery
	Solar energy runs the pump and charges the battery at the same time.	Battery will be fully charged in 1 day.
	Solar energy runs the pump and supplies very little extra energy to the battery.	Battery will be fully charged in 2 to 3 days.
	Pump could only run by using the stored energy in the battery pack.	Battery will not be charged.
	Pump could only run by using the stored energy in the battery pack.	Battery will not be charged.

THE WORKING TIME PER DAY WILL BE VARIOUS AFFECTED BY DIRECT SUNSHINE TIMEING UPON WEATHER AND SEASON.



Scan for assembly instructions.

Instruction for Solar Panel

Solar lights work and water flow by using electricity generated by the solar panel to charge internal batteries. These batteries are then used to power the light and water. When switched on which is on the back of solar panel the lights and water automatically illuminate at night by using a light sensor. The duration of illumination will depend on the amount of sunlight and therefore change received by the solar panel.

POSITION

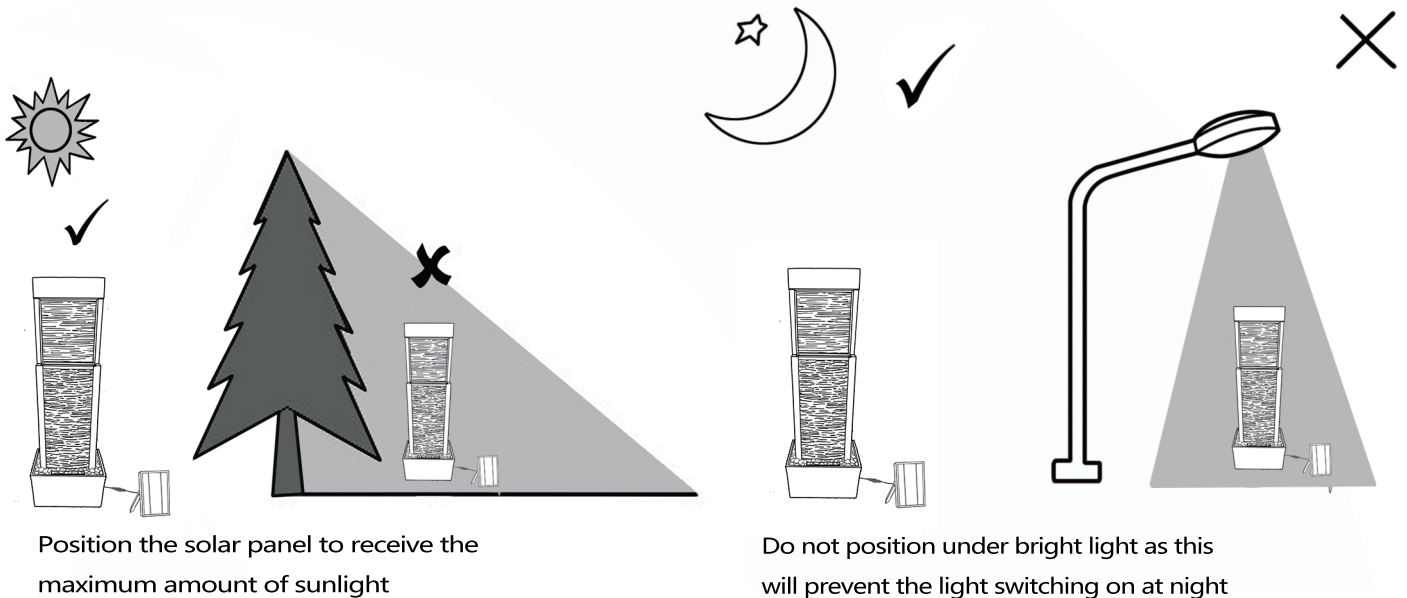

FIRST USE

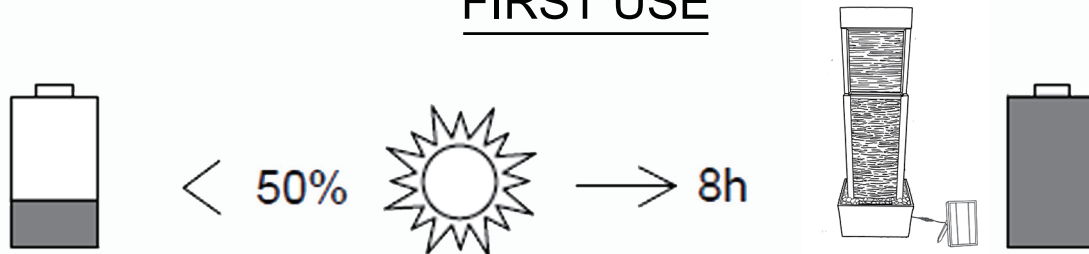

Whilst there may be some initial charge in the battery. We recommend fully charging it before first use. Leave the switch in the "OFF" position for 2 sunny days to ensure the battery is fully charged. Once fully charged switch to "ON" and your lights and water will come on automatically.

NOTE: The diagrams shown are for illustrative purposes only and are not to scale.

INSTRUCTIONS:

1. Turn solar unit on by pressing the power button located on the switch panel.
2. Place the product in direct sunlight.
3. For better performance, make sure solar panel have been fully charged in direct sunlight for approximately 6 - 7 hours.



Scan for assembly instructions.

Warranty

LIMITATIONS

All components are warranted by the manufacturer for a period of 30 days after the date of purchase by the original owner against defects in materials & workmanship under normal use. If it is appropriate to replace your product due to specific defects, the manufacturer will replace the purchase with the same product or a comparable product.

GENERAL TERMS & CONDITIONS

1. Proof of purchase is required to request a claim under this warranty.
2. This warranty applies only to manufacturer errors & defects. The warranty applies to the following:
 - a. Breaks and cracks in the product that originated with the manufacturer
 - b. Missing pieces
 - c. Stains that occurred during the manufacturing process
3. This warranty does not apply to the following:
 - a. Damage due to improper loading, handling, or transportation
 - b. Any costs associated with the installation and removal of products or parts subject to this warranty
 - c. Acts of God
 - d. Products which have been subject to negligence, abuse, accident, misapplication, tampering, alteration, or modification
 - e. Products which have been subject to improper installation, operation, maintenance, repair, or storage
 - f. Products which have been subject to defects that occur when this product is used incorrectly and/or outside of normal application purposes
 - g. Products which have had, including but not limited to, operational failures caused by corrosion, rust, or other foreign materials in the system, or operation at pressures in excess of recommended maximums
 - h. All other possible defects not mentioned here that would not have occurred during manufacturing or during correct, routine use of the item

INSTRUCTIONS

For specific instructions on how to obtain warranty service for your product, please contact Customer Service using the contact information provided. In most circumstances, you will need to return your product either in its original packaging or in equally protective packaging to the address specified by Customer Service.

Before delivering your product for warranty service, it is your responsibility to remove all personal items and belongings you may have stored in your product. Teamson is not responsible for the possible loss, destruction, or damage of any personal items or belongings that have been sent alongside the product.

DISCLAIMER

Any oral statements made about the product by the seller, the manufacturer, the representatives, or any other parties do not constitute warranties, should not be relied upon by the user, and are not part of the contract for sale. The sellers and manufacturers only obligation, and buyers only remedy shall be for the manufacturer to either replace and /or repair at the manufacturers sole discretion, the product as described above. Neither seller nor the manufacturer shall be liable for any injury, loss or damages for lost profits, lost sales, injury to person or property, or any other incidental or consequential loss arising from any cause whatsoever, no matter whether based upon warranty, contract, negligence or other misuse, and the buyer and user agree that no other remedy shall be available to them. Before using, the buyer and user shall determine the suitability of the product for intended use, and assume all risk and liability whatsoever in connection therewith. The warranty and remedy described in this limited warranty is an exclusive warranty and remedy in lieu of any other warranty or remedy expressed or implied. All other warranties and remedies are hereby expressly excluded, including but not limited to any implied warranty of merchantability of fitness for any particular purpose.

OTHER LEGAL RIGHTS

This warranty gives the buyer and user specific legal rights, and buyer and user may also have other rights which vary from state to state. Some states do not allow exclusions or limitation of incidental or consequential damages, so the above limitations or exclusions may not apply to you.

THANK YOU

We appreciate the trust and confidence you have placed in Teamson through the purchase of this product. We strive to continually create quality products designed to enhance your home and life. Visit us online to see our full line of products available for your home décor, toy, and pet needs. Thank you for choosing Teamson!



**Scan for assembly
instructions.**

Exploded Drawing

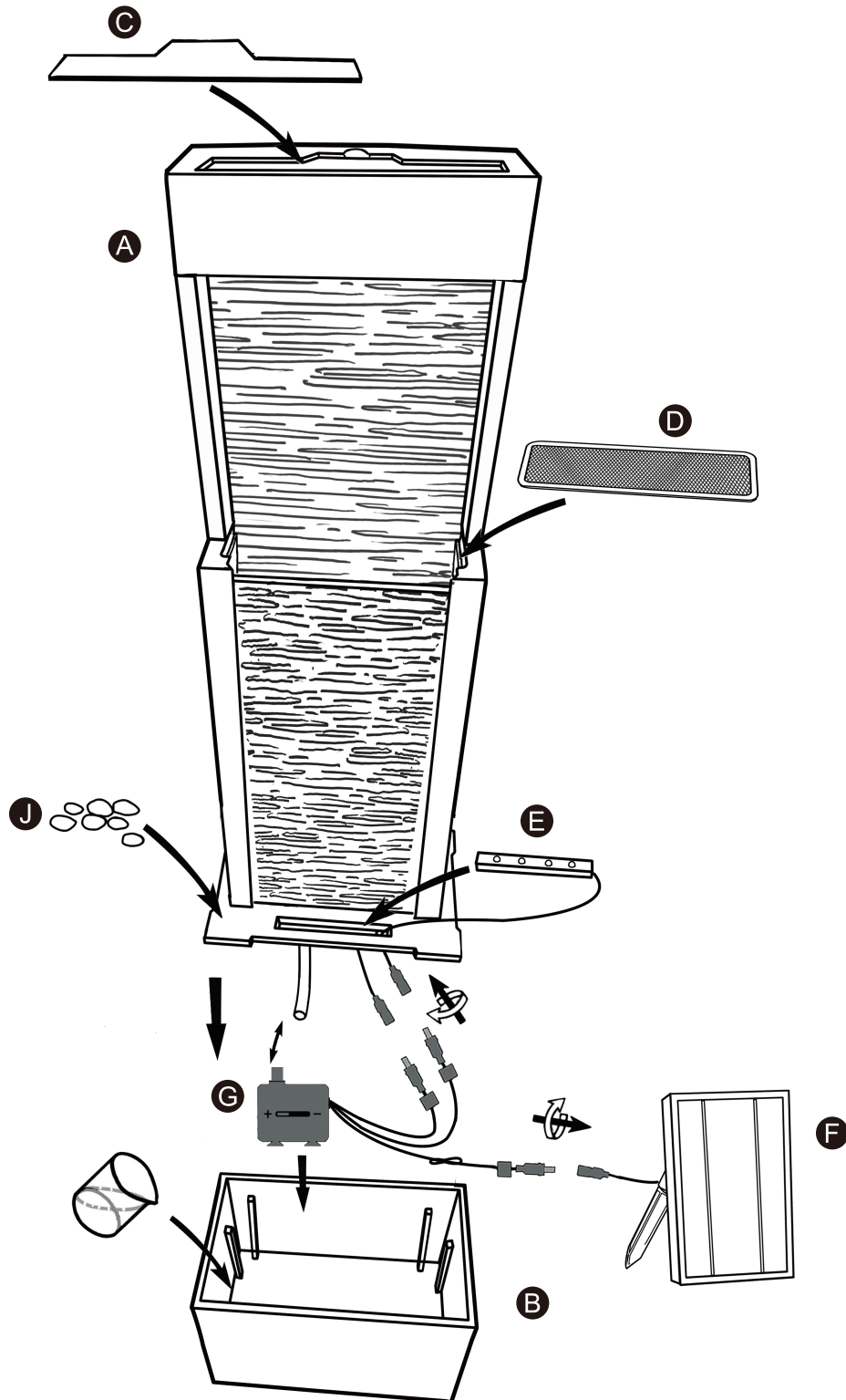

Scan for assembly instructions.

Product Parts

A

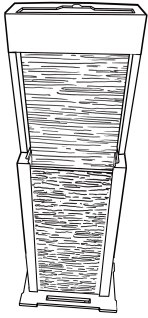

Fountain
1 PC

B

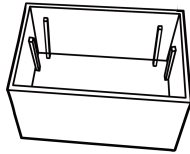

Basin
1 PC

C



Cover
1 PC

D

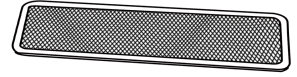

Water splashing
proof screen
1 PC

E

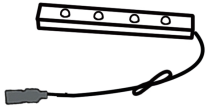

LED Light (Pre-assembled)
1 PC

F

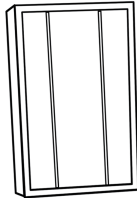

Solar
1 PC

G

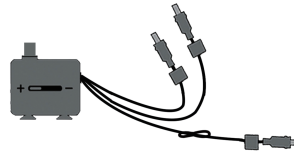

Pump
1 PC

H

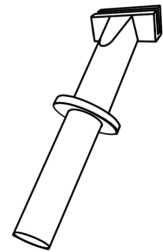

Support
1 PC

I

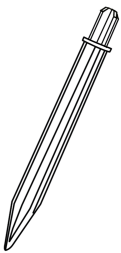

Stake
1 PC

J

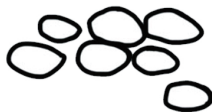

Pebble
1 BAG



Scan for assembly
instructions.

Step 1

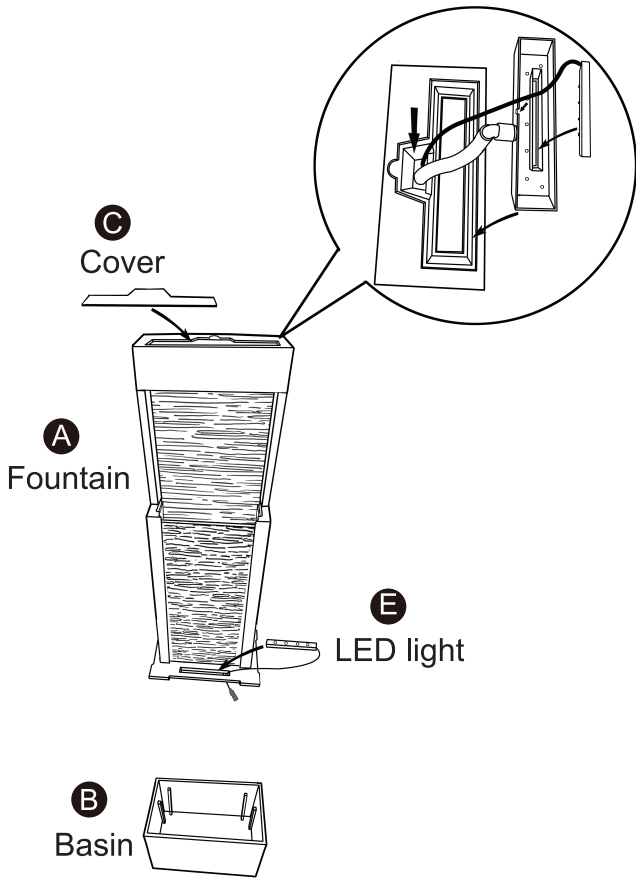

Step 2

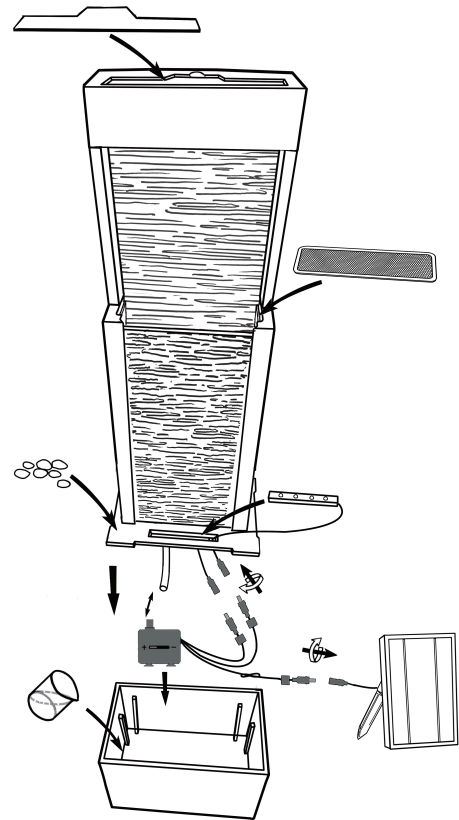

Scan for assembly instructions.