













# ASSEMBLY INSTRUCTION

ITEM: 5961-90851-89 5/0 Upholstered Panel Headboard  
 5961-90852-89 5/0 Upholstered Panel Footboard  
 5961-90867-89 6/0-6/6 Upholstered Panel Headboard  
 5961-90868-89 6/0-6/6 Upholstered Panel Footboard  
 5961-90853-89 5/0-6/6 Rails  
 5961-90863-89 6/0 Rails

Thank you for purchasing this quality product. Be sure to unpack carefully looking for small parts which may have come loose during shipment. Read all instruction and study the drawing carefully before starting the assembly process.

HARDWARE PACK					PARTS LIST			
NO.	DRAWING	DESCRIPTION	SIZE	Q'TY	NO.	DRAWING	DESCRIPTION	Q'TY
A		Open Wrench	5/16"	1PC	1		Headboard	1PC
B		Nut	5/16"	8PCS	2		Rails	2PCS
C		Curved Washer	5/16"	8PCS	3		Footboard	1PC
D		Threaded Rod	5/16*100mm	8PCS	4		Slats	5PCS (FOR 6/6 & 6/0 BED) 4PCS (FOR 5/0 BED)
E		Screw	8*32mm	20PCS (FOR 6/6 & 6/0 BED) 16PCS (FOR 5/0 BED)	5		Support leg	5PCS (FOR 6/6 & 6/0 BED) 4PCS (FOR 5/0 BED)
F		Lock Washer	5/16"	8PCS				
G		Flat Washer	5/16"	8PCS				

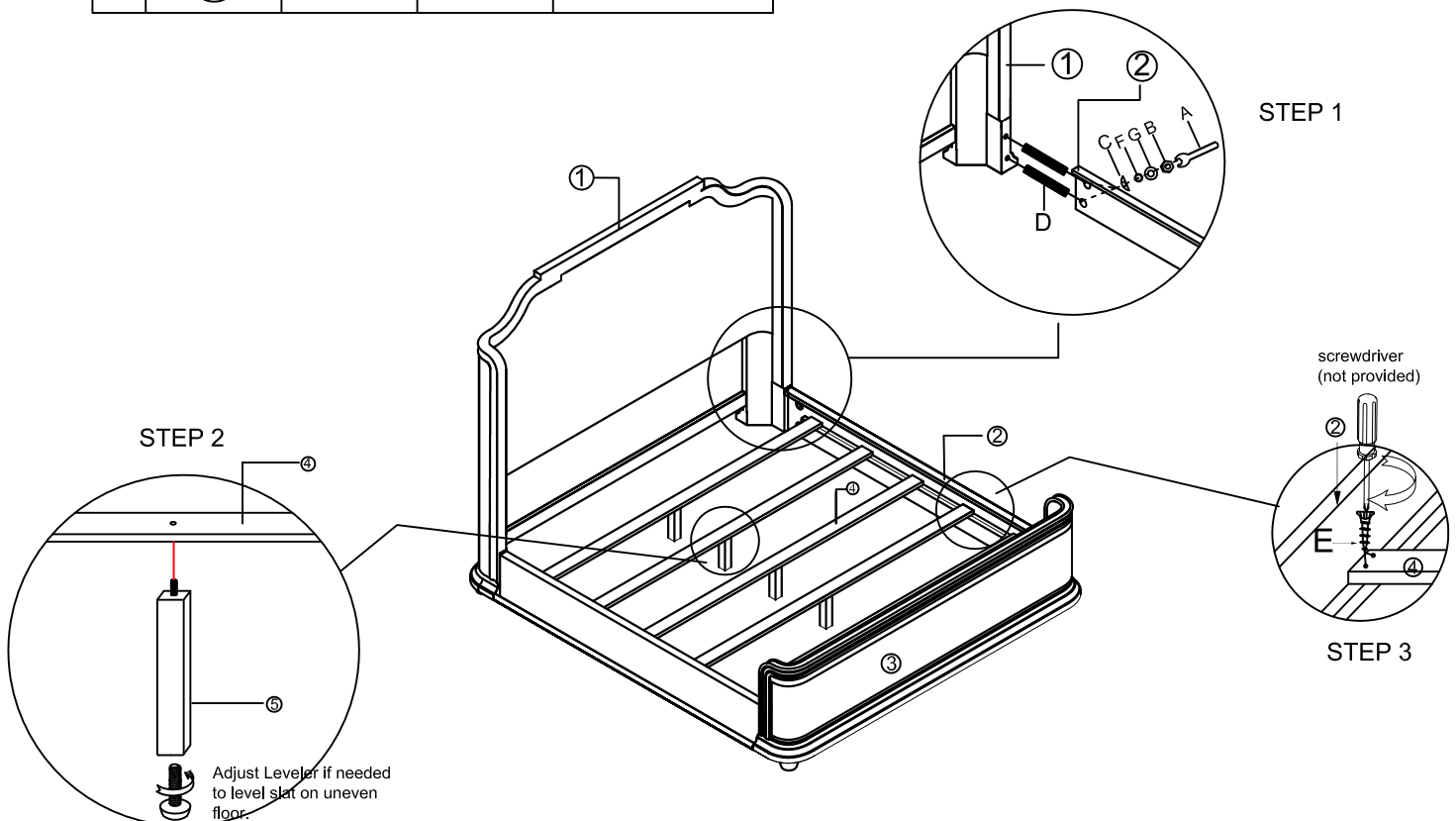

**Step 1:** Attach Rails (2) to Headboard (1) and Footboard (3) by using Threaded Rods (D), Curved Washers (C), Lock Washers (F), Flat Washers (G) and Nuts (B), tighten them with Open Wrench (A).

**Step 2:** Attach support legs (5) to slats (4).

**Step 3:** Attach slats (4) to the rails (2) and tighten them by using Phillips head screwdriver.