



Send Us a Text: 1-812-652-2525
(US and Canada Only. Carrier Fees May Apply)



Find Us Online: www.safety1st.com

Email Us: support@djgusa.com



Give Us a Call: 1-800-544-1108
(Toll Free, US and Canada Only)

Replacement Parts List (on select models)

- Buckle Assembly
- Chest Clip
- Seat Pad Set
- Lower Anchor Belt
- Base

- Locking Clip
- Harness Straps
- Instructions

For parts availability and questions, call, text, or chat.

If requested color is not available, similar color will be substituted.

Applicable tax and shipping & handling will also be added.

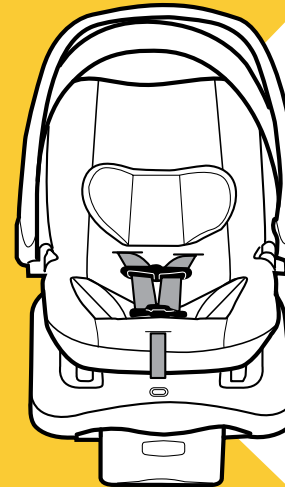

onBoard 35 SecureTech™ Infant Car Seat

Your model may look different than one shown on cover.

**Read all instructions BEFORE USING this car seat.
KEEP INSTRUCTIONS FOR FUTURE USE.**

⚠ Failure to follow the warnings on the labels and in the instruction manual can result in serious injury or death to your child.

4358-8257 2.11.22



Welcome to the Safety 1st Family!

Thank you for choosing this car seat, also known as a child restraint!

To help you get started using your child's new car seat, here are the 4 main tasks you'll need to complete.

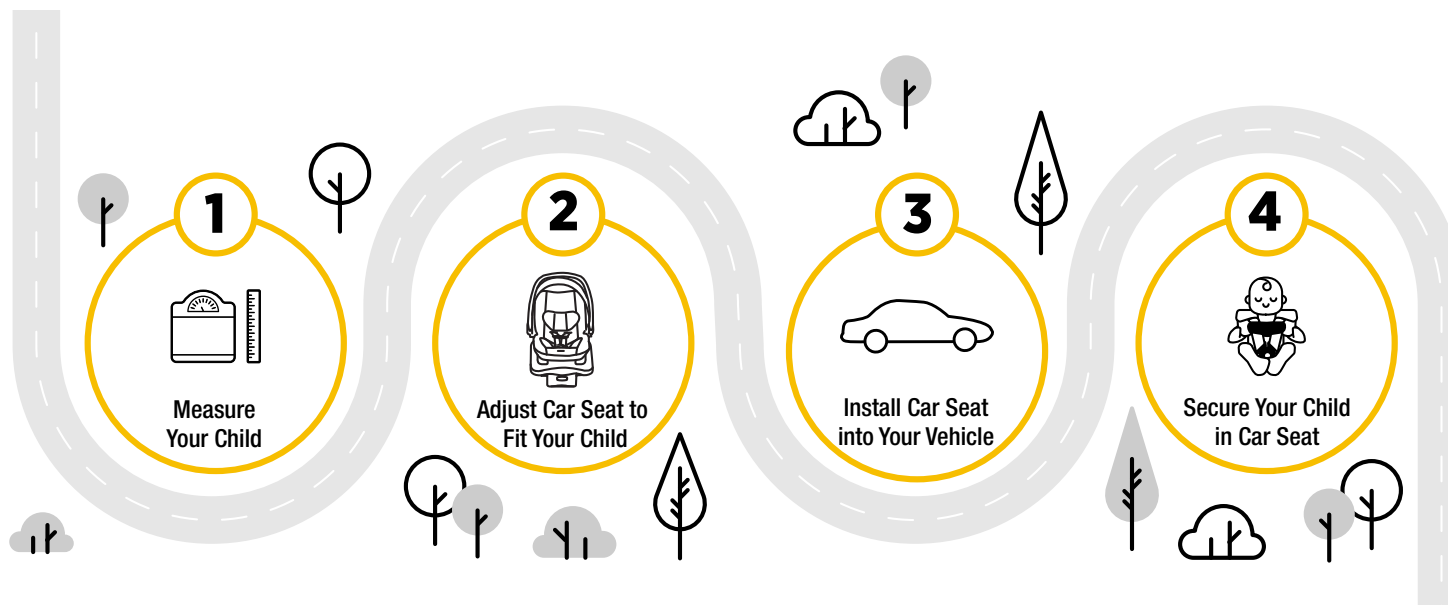

Your child's safety is worth the time it will take to read and follow these instructions.

Ready? Let's go!

Pages 1-8 will introduce you to the parts of the car seat.

The Back Cover of this Manual has our contact information.

If at any point you would like assistance, please feel free to reach out to us.

Contents

1 Getting Started

- 1 Parts of Car Seat
- 4 Accessory Use
- 5 Canopy Use
- 7 Base Use

9 Rear-Facing Use

- 9 Car Seat Use
- 10 Rear-Facing
- 12 Rear-Facing Child Fit
- 14 Securing Child in Car Seat
- 17 Carrier Use
- 18 Vehicle Install with Base

- 24 Attaching Car Seat to Installed Base
- 27 Removing Car Seat from Base
- 28 Vehicle Install without Base

33 Making Adjustments to Car Seat

- 33 Changing Harness Height
- 35 Changing Buckle Position
- 38 Harness System Adjustments for Smaller Infants

42 Wash & Care

- 42 Removing Harness System
- 45 Removing Seat Pad Set

- 47 Cleaning Parts of Car Seat & Installing Seat Pad Set
- 48 Installing Harness System

53 LATCH & Vehicle Belt Information

- 53 LATCH: Lower Anchor Belt
- 55 Vehicle Belts

60 Safety Information

- 60 Child Restraint Use
- 61 Vehicle Seating Position
- 62 Installation in Vehicle
- 63 Replacement & Expiration
- 64 Registration & Safety Notices
- 65 Aircraft Information

66 Warranty

©2022 Dorel Juvenile Group, Inc. Safety 1st™ and the Safety 1st logo and design are trademarks of Dorel Juvenile Group, Inc. (800) 544-1108 www.safety1st.com. Styles and colors may vary. Los estilos y los colores pueden variar. Made in CHINA. Hecho en CHINE. Distributed by (distribuido por) Dorel Juvenile Group, Inc., 2525 State St., Columbus, IN 47201-7494. Dorel Juvenile Canada, 2233 Argenta Road, Suite 110, Mississauga, ON L5N 2X7. Importado y Distribuido en Chile por: Comercial e Industrial Silfa S.A. - San Ignacio 0201 / Parque Industrial Portezuelo Quilicura, Santiago Chile. Fono (562) 2339 9000. En Perú por: Comexa S.A. - Los Libertadores 455 - San Isidro, Lima - Perú. Fono (511) 4469014. En Centro América, Caribe y Ecuador por: Best Brands Group S.A. - Av. Balboa, Bay Mall Plaza, Planta Baja, local 9, Panamá. - Fono: (507) 300 2884. En Colombia por: Baby Universe S.A.S. - Via 40 No. 77-29, Barranquilla, Colombia - Fono: (575) 353 1110 Importador: DJGM, S.A. DE C.V. Gabriel Mancera No. 1041 Col. Del Valle, Benito Juárez C.P. 03100 México, Ciudad de México R.F.C. DJG140305GN9 Tel. (55) 67199202



Parts of Car Seat

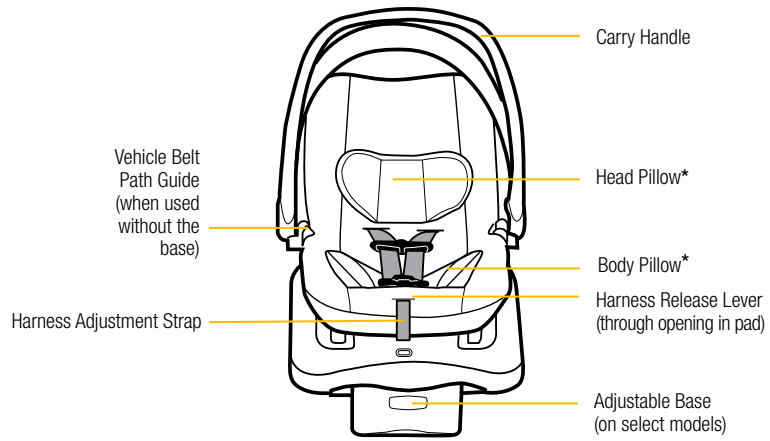

Your model may look different than one shown.

*See page 4 for Accessory Use.

Harness System

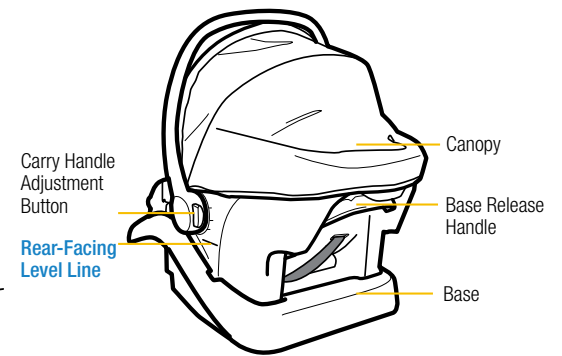
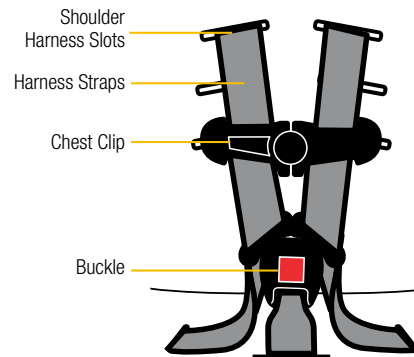

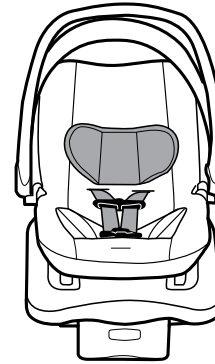
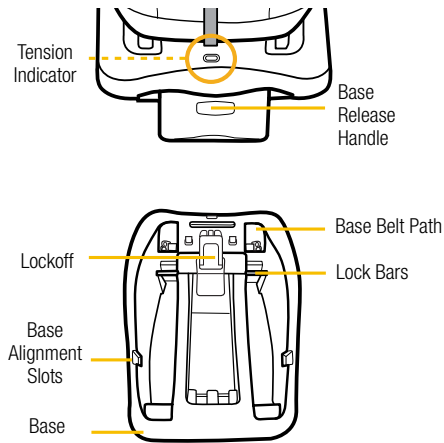
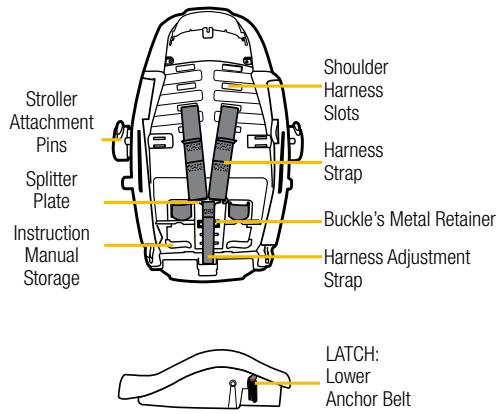

Head Pillow
(on select models)

When using the head pillow, make sure it does not cover your infant's face in any way.

To remove, from the back of the head pillow gently pull the fabric tabs out from the shoulder harness slots.

To attach, slide the fabric tabs into the shoulder harness slots.

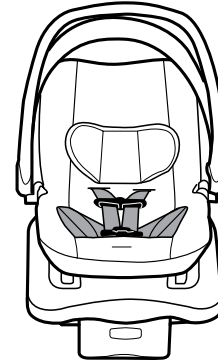

Body Pillow
(on select models)

To remove, unbuckle the harness. Pull the buckle down through the slot in the body pillow.

Slide it out from behind the harness straps.

Canopy Use

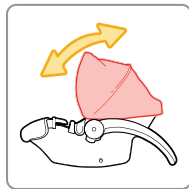
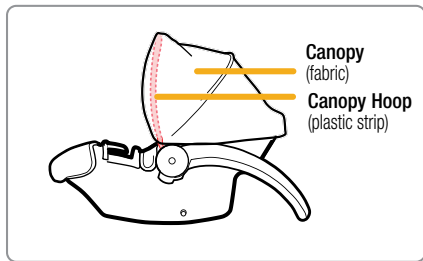

To Adjust Canopy

Grasp the front or sides of the canopy hoop and move it front to back to desired location.

To Remove Canopy

1

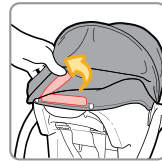

Undo Fastening Strip on Back of Car Seat

2

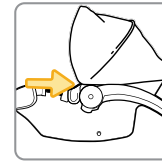

Locate Canopy Post

There is one on either side of the car seat. You only need to undo one to remove the canopy.

3

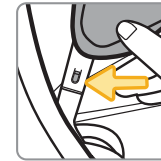

Pull Back Canopy Fabric to Locate Tab on Canopy Post

4

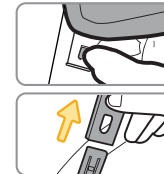

Press Tab In With Your Thumb & Pull Canopy Hoop Off Canopy Post

5

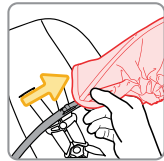

Slide Canopy Fabric Off Canopy Hoop

Reverse to put back together.

Base Use

Depending on your model, the base is adjustable.

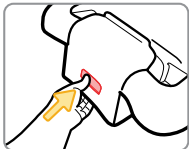

To Lower Base Foot

Push in on the foot release button and pull the foot all the way down.

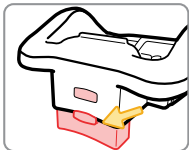
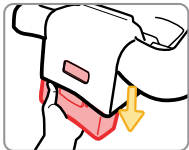

Lock the foot on the release button as shown.

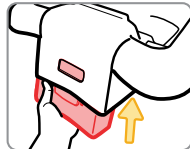

To Store Base Foot

Pull the foot down and press in on the release button.

Push the foot up into the base to the locked position.

Release Lever for Vehicle Belt Lockoff & LATCH: Lower Anchor Belts

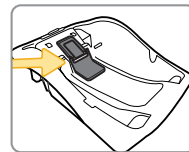

This base has a release lever that has two functions; one for LATCH: lower anchor belts and one for vehicle belts.

Lockoffs prevent the vehicle belt from loosening after tightening.

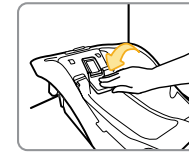

Closing Release Lever

Push the release lever down to close the Lockoff and to allow the LATCH: lower anchor belts to retract.

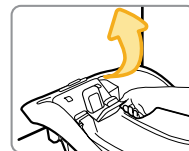

Opening Release Lever

Lift the release lever to open the Lockoff and to release the LATCH: lower anchor belts.

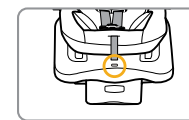

Tension Indicator

This base has indicators that show when the LATCH: lower anchor belt or vehicle belt have been securely tightened.

The red will turn completely green when tightened correctly. No red should be showing.

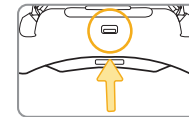

⚠ WARNING:

Measure your child's weight and height **(DO NOT guess)** before using this car seat.

This car seat can only be used
REAR-FACING.

Your child's height, weight, and age determine how the car seat should be placed in the vehicle.

Children vary widely in body size, shape, and temperament—**please consult your doctor before switching between any types or modes of a car seat within the limits and fit requirements of the car seat.**

State Laws

Please be certain to follow your state's laws regarding car seat use.

American Academy of Pediatrics Recommendations**Infants and Toddlers**

Should ride in a rear-facing car seat as long as possible, until they reach the highest weight or height allowed by their car seat.

Toddlers and Preschoolers

Once they are facing forward, children should use a forward-facing car seat with a harness for as long as possible, until they reach the height and weight limits for their car seats.

School-Aged Children

Once they have outgrown their forward facing car seat, children should use a belt-positioning booster seat until the vehicle's lap and shoulder seat belt fits properly. This is often when they have reached at least 4 feet 9 inches in height and are 8 to 12 years old.

Older Children

All children younger than 13 years should be restrained in the rear seats of vehicles for optimal protection.

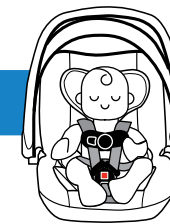
**4-35 lb (1.8-15.9 kg) and 32 in. (81.3 cm) or less in height**

Children under 1 year of age **MUST** ride **Rear-Facing**.

In this car seat, your child can remain **Rear-Facing until they outgrow any one of the following:**

- **Weight Limit:** 35 lb (15.9 kg); **OR**
- **Height Limit:** 32 in. (81.3 cm); **OR**
- **Rear-Facing Child Fit** requirements, see page 12.

Before installing the car seat in your vehicle, check your child's fit in the car seat.

This way you won't have to redo the vehicle installation to make adjustments to the car seat.

Rear-Facing Child Fit: Page 12

Rear-Facing Vehicle Install: Page 18

⚠ WARNING:



NEVER install a rear-facing child restraint in the front seat of a vehicle equipped with an active frontal airbag.

DO NOT use the lower anchor belt along with the vehicle lap or lap/shoulder belt.

DO NOT fasten multiple lower anchor hooks on the same lower anchor bar in the vehicle.

Check the vehicle belt or the lower anchor belt before each use. Use **ONLY** if the belt can be tightened properly and locked securely in place.

Even when unoccupied, this child restraint **MUST** be firmly secured to the vehicle with the lower anchor belt or with the vehicle seat belt.

This child restraint **MUST ALWAYS** face the rear of the vehicle.

Rear-Facing Child Fit

1

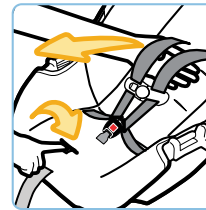

Fully Loosen Harness Straps

Push down on the harness release lever (through the opening in the pad) while pulling out on the harness straps as shown.

2

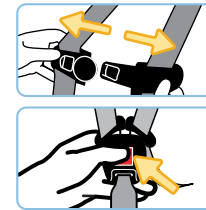

Undo Chest Clip & Buckle

It may be easier to undo the buckle by pressing in towards the top of the straps as shown.

3

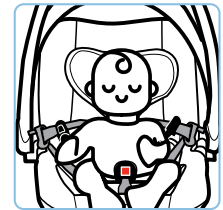

Place Child in Car Seat

Your child's bottom and back should be flat against the car seat.

4

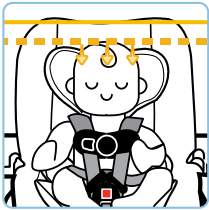

Check Head Position

The top of your child's head **MUST be at least 1 in.** (2.5 cm) **below** the top of the car seat.

5

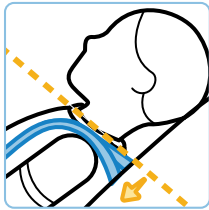

Check Harness Strap Position

The harness strap **MUST be at or slightly below** the shoulders; never above.

6

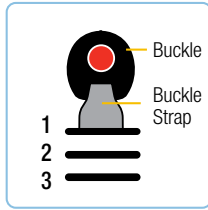

Check Buckle Position

- Use the slot closest to your child.
- The buckle should **not be underneath or behind** your child.



To change the harness strap height, see page 33.

To change the buckle position, see page 35.

To learn how to check harness tightness, see pages 14-16.

If you cannot achieve a snug harness fit for your child, see pages 38-41.

1

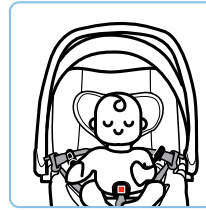

Place Child in Car Seat

Your child's bottom and back should be flat against the car seat.

Position the harness straps over your child's shoulders and upper thighs.

2

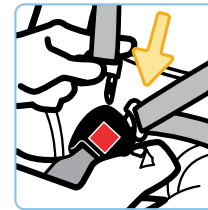

Buckle Harness

Pull the harness straps up to make sure the buckle is locked.

3

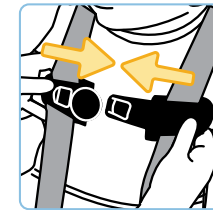

Fasten Chest Clip

Insert right half of the chest clip into the left half and snap together.

4

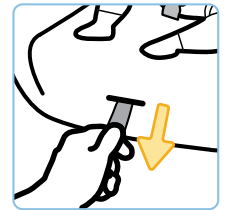

Tighten Harness

Pull the harness adjustment strap straight out to snugly tighten the harness.

continued on next page

5

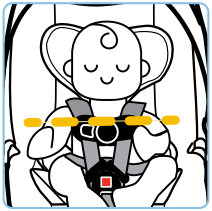

Position Chest Clip

Slide the chest clip up the harness straps and position it at mid-chest (even with armpits) and away from your child's neck.

6

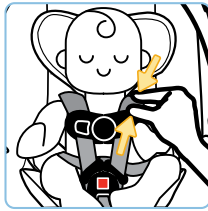

Check Harness Tightness

Try to pinch the harness at the shoulders vertically between index finger and thumb as shown.

If your fingers slip off, the harness is tight enough.

If you can pinch the harness strap, tighten more.



A snug strap should not allow any slack.

It lies in a relatively straight line without sagging.

It does not press on the child's flesh or push the child's body into an unnatural position.

FINISHED!



Your child is now secured in the car seat. Check your child's fit often and make any needed adjustments to the car seat as they grow.

To Remove Child from Car Seat:

1. Loosen Harness Strap
2. Unbuckle Harness
3. Release Chest Clip
4. Remove Child

Clean with warm water and/or remove the object with tweezers. If you cannot get the harness to adjust and remain tight with the buckle securely locked, **DO NOT** use this car seat.

Troubleshooting

1. If the buckle or harness release lever sticks: DO NOT lubricate. Check for dropped food, sticky spilled drinks, dirt, leaves, etc.

2. If your harness twists:

Straighten the harness each time you put your child in the car seat. Lock the buckle and tighten the harness so it will be ready for next use.

⚠️ WARNING:

Failure to fasten and tighten the harness system correctly may allow the child to be ejected from the child restraint in a crash or sudden stop causing serious injury or death.

DO NOT mistake comfort for safety. The harness system **MUST** be snugly adjusted.



DO NOT put snowsuits or bulky garments on your child when placing them in the child restraint.

Bulky clothing can prevent the harness straps from being tightened properly.

Carrier Use

**To Adjust Carry Handle**

Squeeze both adjustment buttons on each side of the carry handle.

Rotate up or down to desired location. Release buttons.

Make sure both carry handle adjuster buttons are in the locked position.

Carry handle **MUST** be upright **and** locked when carrying and when installed in the vehicle.

⚠ WARNING:

Read ALL instructions before using child restraint as a carrier.

NEVER use carrier unless child is properly secured.

Use only as a carrier by children weighing 4-35 pounds (1.8-15.9 kg) and 32 inches (81.3 cm) or less in height.

NEVER leave child unattended. Always keep child within arm's reach.

Suffocation Hazard: Infant carrier can roll over on soft surfaces and suffocate child. **NEVER** place carrier on beds, sofas or other soft surfaces.

Strangulation Hazard: Children have **STRANGLING** in loose or partially buckled harness straps. Fully restrain the child even when carrier is used outside the vehicle.

Fall Hazard: Child's activity can move carrier. **NEVER** place carrier on counter tops, tables, or any other elevated surface.



The carrier can fall from the shopping cart. Do not use on shopping cart.

Do not use the carrier if it is damaged or broken, or if any parts are missing.

Vehicle Install with Base

**Review Vehicle Owner's Manual**

Determine what kind of vehicle belts your car has and how to use them to lock a car seat in place **OR** where LATCH: lower anchor seating positions are located in your vehicle.

There are 2 different methods for install.

Use only one:

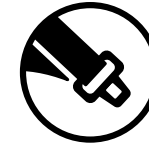

Vehicle Belt



LATCH: Lower Anchor Belt

⚠ WARNING:

DO NOT use both the LATCH: lower anchor belt and vehicle belt at the same time to install the base.

continued on next page

1

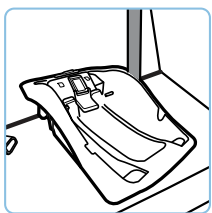

Place Base Rear-Facing in Vehicle

Center the base in the chosen seating position.

2

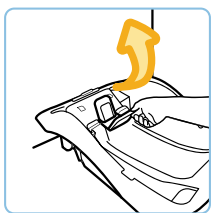

Lift Release Lever

3

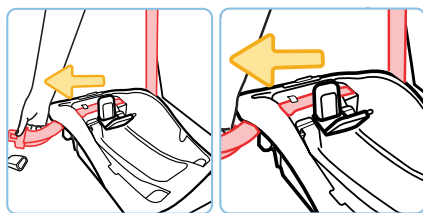

For Vehicle Belt Install: Route Belt Through Base Belt Path Openings As Shown

4

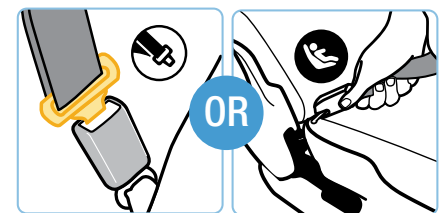

Buckle Vehicle Belt

If your car has a **switchable retractor**, you **MUST** also use it to lock the belt. Review page 55 of this manual or your vehicle owner's manual.

Attach Lower Anchor Belt Connectors to Vehicle's Lower Anchors

5A

Vehicle Belt

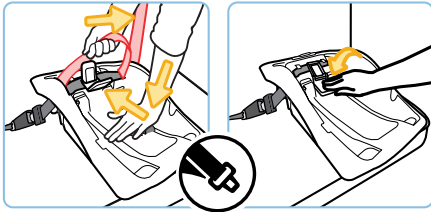

Tighten Vehicle Belt & Then Push Release Lever Down

Place your hand in the base and firmly push the base down and back towards the vehicle seat. Pull the belt towards you and parallel (in line) with the belt path as shown.

OR

5B

LATCH

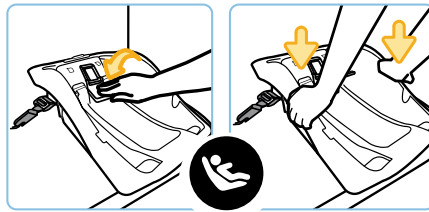

Push Release Lever Down & Push Down on Base to Tighten LATCH Belt

You **MUST** push the release lever down in order for the LATCH: lower anchor belts to tighten.

Then push down on the base to tighten the LATCH: lower anchor belts. The belts will begin to automatically retract and tighten as you push down.

i

If the Lockoff cannot be used properly, then do not install the base using vehicle belt installation.

6

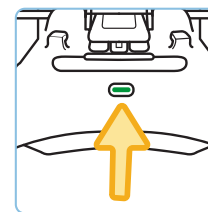

Check Tightness Indicator

The red will turn completely green when tightened correctly.

No red should be showing.



i

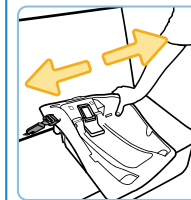

If the base moves more than 1 in. (2.5 cm), you can try:

- Pulling the belt tighter; **OR**
- Reinstalling the base; **OR**
- Changing to a different seating location; **OR**
- Switching to a different install method (LATCH or vehicle belt).

You can also check the tightness by:

- Holding the base **ONLY** at the belt path with your non-dominant hand.
- Pushing and pulling from side to side.
- The base should not move more than 1 in. (2.5 cm).

continued on next page

FINISHED!

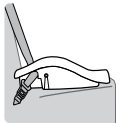

Lap/Shoulder Belt

✓ **Vehicle Belt Install:** Is the vehicle belt locked? See steps 4 and 5A.

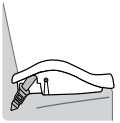

Lap Belt

✓ **LATCH: Lower Anchor Belt Install:** Are the connectors securely attached to the vehicle's lower anchors? See steps 4 and 5B.



LATCH: Lower Anchor Belt

✓ Is the belt tightened enough so that the tension indicator is fully green? Check the tightness of the install often to make sure it has not loosened. See step 6 and last info box on page 22.

1

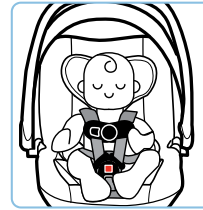

Secure Child in Car Seat

See pages 14-16.

2

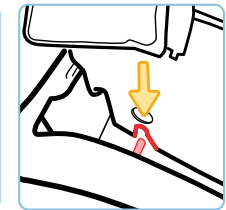
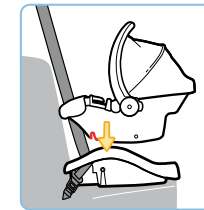

Attach Car Seat to Base

Pull up on the front two corners of the car seat by your child's feet to make sure it is locked to the base.

The carry handle MUST be upright and locked when installed in the vehicle.

continued on next page

3

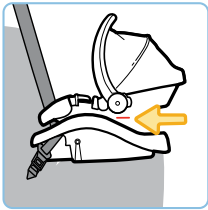

Check Level Line

Redo the base installation if the level line is not parallel with the ground.

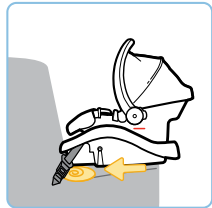

Only if necessary, you may need to place a tightly rolled towel(s) or foam pool noodle(s) under the front of the base to help make the level line parallel with the ground.

Check often to make sure padding is still in place and the belt is tight.

FINISHED!

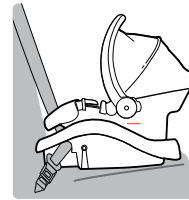

Lap/Shoulder Belt

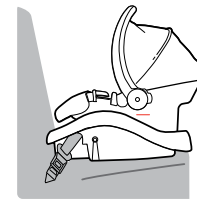

Lap Belt

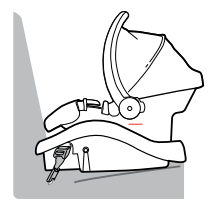

LATCH: Lower
Anchor Belt

Removing Car Seat from Base

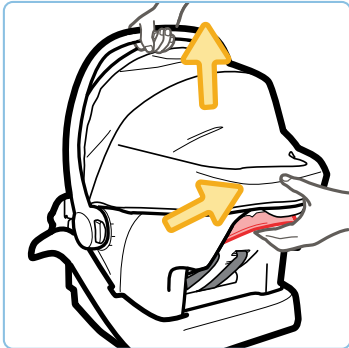

To Remove Car Seat from Base

From the back of the car seat, slide the base release handle up and lift the car seat out of the base.

Vehicle Install without Base



Review Vehicle Owner's Manual

Determine what kind of vehicle belts your car has and how to use them to lock a car seat in place **OR** where LATCH: lower anchor seating positions are located in your vehicle.



Lap/Shoulder Belt

OR



Lap Belt

continued on next page

1

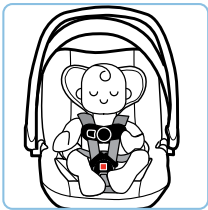

Secure Child in Car Seat

See pages 14-16.

Place car seat **Rear-Facing** in seat.

2

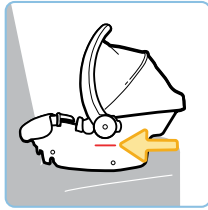

Check Level Line

The Level Line **MUST** be parallel with the ground.

The carry handle must be upright and locked when installed in the vehicle.

3

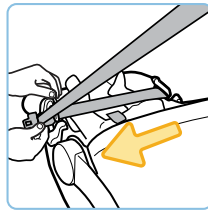

Route Vehicle Lap or Lap/Shoulder Belt Through Belt Path As Shown

4

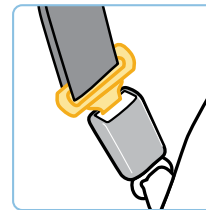

Buckle Vehicle Belt

If your car has a switchable retractor, use it to lock the vehicle belt.

Review page 55 of this manual or your vehicle owner's manual.

5

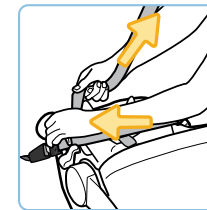

Tighten Vehicle Belt

Lay your forearm across the car seat at the belt path while pulling up on the belt to tighten.

6

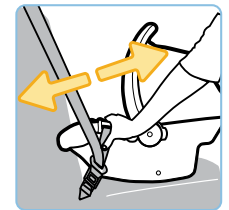

Check Belt Tightness

Hold the **Rear-Facing Belt Path** with your non-dominant hand. Push and pull the car seat from side to side.

The car seat should not move more than **1 in.** (2.5 cm).

continued on next page



If the car seat moves more than 1 in. (2.5 cm), you can try:

- Pulling the belt tighter; **OR**
- Reinstalling the car seat; **OR**
- Changing to a different seating location.

7

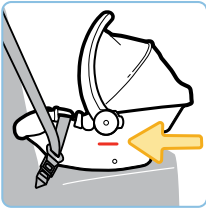

Recheck Level Line

Redo the installation if the level line is not parallel with the ground.

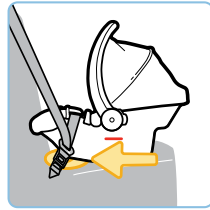

Only if necessary, you may need to place a tightly rolled towel(s) or foam pool noodle(s) under the front of the car seat to help make the level line parallel with the ground.

Check often to make sure padding is still in place and the belt is tight.

FINISHED!

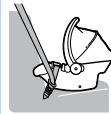

Lap/Shoulder Belt



Lap Belt

- Vehicle Belt Install:** Is the vehicle belt locked? See step 4.
- Is the belt tightened enough so that the car seat does not move more than 1 in (2.5 cm) from side to side? Check the tightness of the install often to make sure it has not loosened. See step 6 and info boxes on page 31.
- Is the Level Line parallel with the ground? See step 7 and last info box on page 31.

Changing Harness Height

1

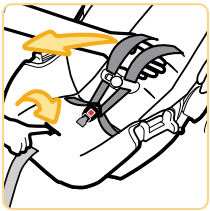

Fully Loosen Harness Straps

Push down on the harness release lever (through the opening in the pad) while pulling out on the harness straps as shown.

2

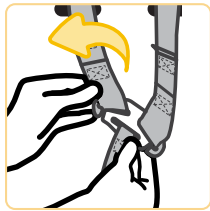

From Back of Car Seat, Remove Harness Strap Loops From Splitter Plate

3



Pull Harness Straps Out of Shoulder Harness Slots

4

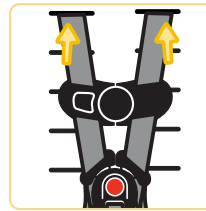

Rethread Harness Straps into Correct Shoulder Harness Slots for Your Child

For [Rear-Facing Child Fit](#), see page 12.

5

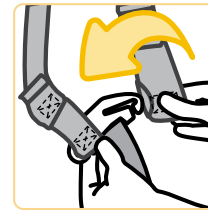

From Back of Car Seat, Attach 1st Harness Strap Loops to Splitter Plate As Shown

i

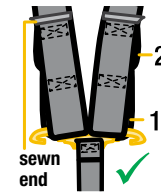

The sewn ends of the harness strap loops **MUST** face towards you.

DO NOT twist the harness strap or the harness adjustment strap.

Make sure the harness strap loops are fitted completely on both sides of the splitter plate.

For [Rear-Facing Child Fit](#), see page 12.

To learn how to check harness tightness, see pages 14-16.

If you cannot achieve a snug harness fit for your child, see pages 38-41.

Check the harness straps often for any wear or damage.

Changing Buckle Position

⚠ WARNING:

Failure to place buckle's metal retainer completely through pad and child restraint can result in serious injury or death.

1

**Undo Buckle**

It may be easier to undo the buckle by pressing in towards the top of the button.

2

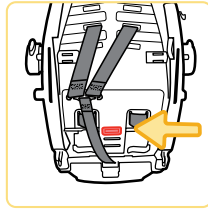
**Turn Car Seat Over**

Locate the buckle's metal retainer on the bottom of the car seat.

3

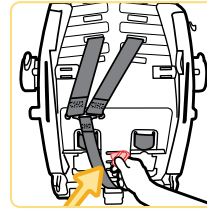
**Rotate Metal Retainer and Push It Up Through Car Seat & Pad**

4

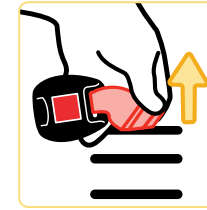
**From Top of Car Seat, Pull Buckle Out of Car Seat & Pad**

5

**Insert Buckle's Metal Retainer into Buckle Slot Closest to Child**

The buckle **MUST** face out.

6

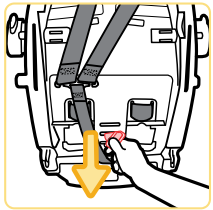

From Bottom of Car Seat, Pull Metal Retainer Completely Through Pad & Car Seat

7

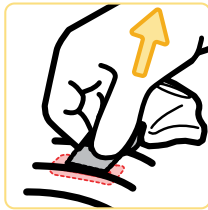

Check Buckle

Pull the buckle up to make sure it is secured.

The buckle **MUST NOT** pull out.

i

For Rear-Facing Child Fit, see page 12.

To learn how to check harness tightness, see pages 14-16.

If you cannot achieve a snug harness fit for your child, see pages 38-41.

i

If you cannot achieve a snug harness fit for your child, you may need to adjust the buckle strap and/or harness strap length and location as shown in this section.

WARNING:

The harness system **MUST** be installed correctly. **DO NOT** use a child restraint with damaged harness straps.

Adjusting Buckle

1

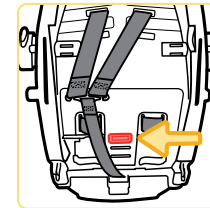

With Buckle in 1st Slot, Turn Car Seat Over

If you need to move the buckle to the 1st slot, see pages 35-37.

2

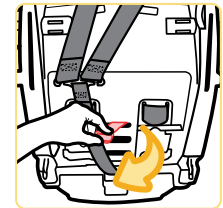

Pull Buckle's Metal Retainer Towards You, Then Push It Up into Middle Buckle Slot As Shown

continued on next page

3

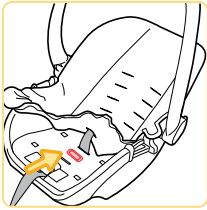

From Top of Car Seat,
Lay Metal Retainer
Flat Against Car Seat

4

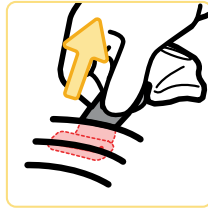

Tuck Car Seat Pad
Around Front of Car
Seat & Check Buckle

Pull the buckle up to make sure
it is secured.

The buckle **MUST NOT** pull out.

Adjusting Harness Straps

1

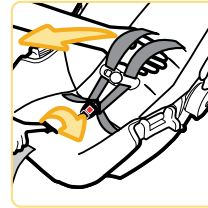

Fully Loosen
Harness Straps

2

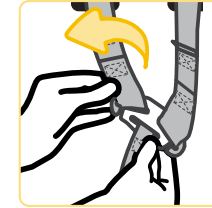

From Back of
Car Seat, Remove
Harness Strap Loops
From Splitter Plate

3

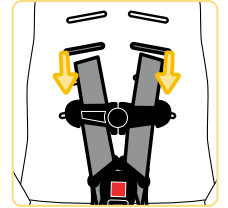

Pull Harness
Straps Out of
Shoulder
Harness Slots

continued on next page

4

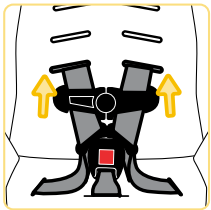

Rethread Harness Straps into Correct Shoulder Harness Slots For Your Child

For **Rear-Facing Child Fit**, see page 12.

5

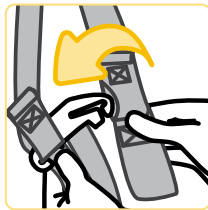

Attach 2nd Harness Strap Loops to Splitter Plate As Shown

i

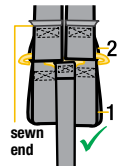

The sewn ends of the harness strap loops **MUST** face towards you.

DO NOT twist the harness strap or the harness adjustment strap.

Make sure the same harness strap loops are fitted completely on both sides of the splitter plate.

i

You need to remove the harness system in order to remove the seat pad for cleaning. Only remove the harness system to clean the seat pad.

To remove accessories, see page 4.

1

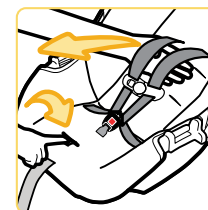

Fully Loosen Harness Straps

2

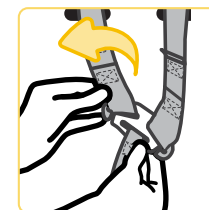

From Back of Car Seat, Remove Harness Strap Loops From Splitter Plate

3

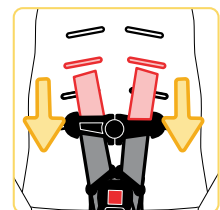

Pull Harness Strap Out of Shoulder Harness Slots

continued on next page

4

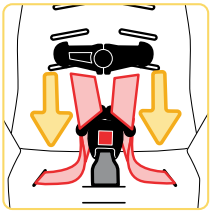

Unthread Chest Clip

5

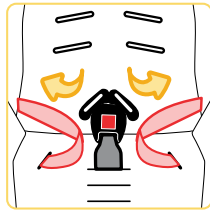

Unthread Buckle
DO NOT undo the buckle.

6

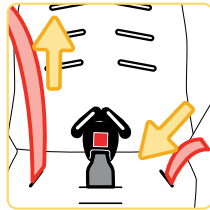

Pull Harness Strap
Out of Seat

7

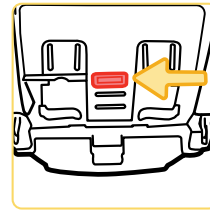

Turn Car Seat Over
Locate the buckle's metal
retainer on the bottom of
the car seat.

8

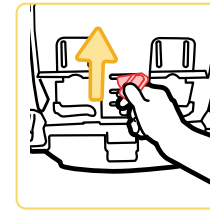

Rotate Metal
Retainer & Push It Up
Through Car Seat &
Pad As Shown

9

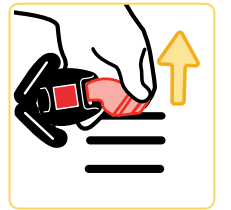

From Top of Car Seat,
Pull Buckle Out
of Car Seat

Removing Seat Pad Set

i

You need to remove the harness system in order to remove the seat pad. See pages 42-44.

To remove accessories, see page 4.

1

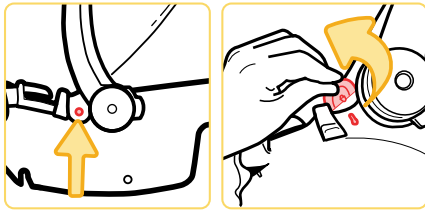

Release Pad Tabs

Pull down on the pad and pull the tab out of the car seat.
Repeat for the other side.

2

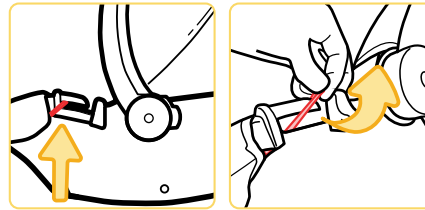

Release Elastic Straps

Pull the elastic strap off of the belt path guide as shown.
Repeat for the other side.

3

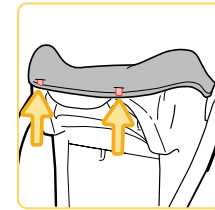

**Pull Pad off Tabs
from Top of Car Seat**

4

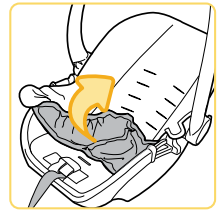

**Remove Pad from
Bottom of Car Seat**

Remove the pad from the car seat.

Cleaning Pad & Accessories

Machine wash separately with cold water on a gentle cycle. **DO NOT** use bleach. Tumble dry separately for 10-12 minutes on low heat. Remove immediately.

Cleaning Harness Strap

Check the harness straps often for any wear or damage. Spot clean using warm sudsy water and damp cloth. Spilled food and liquids on the car seat may result in mold or bacterial growth over time. These spills could also attract insects or rodents.

To Clean Canopy

Hand wash using warm sudsy water. Line dry.

Cleaning Buckle & Car Seat

Spot clean using warm sudsy water and damp cloth. **DO NOT** submerge into water.

Installing Seat Pad Set

1. Starting from the top of the car seat, slip the pad on the car seat. Push the pad tabs at the top of the car seat through the slots in the pad.
2. Pull the harness adjustment strap through the slot in the pad. Wrap the pad around the bottom of the car seat.
3. Attach the tabs on the sides to the car seat. Attach the elastic straps to the belt path guides.

Install the harness system. See pages 48-52.

⚠ WARNING:

DO NOT use the child restraint without the seat pad or with damaged harness straps.

1



Insert Buckle's Metal Retainer into Buckle Slot Closest to Child

The buckle **MUST** face out.

2

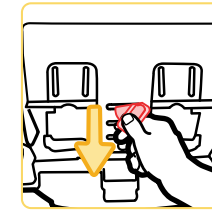

From Bottom of Car Seat, Pull Metal Retainer Completely Through Pad & Car Seat

3

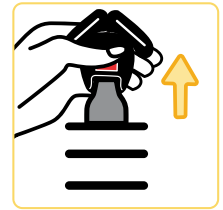

Check Buckle

Pull up on the buckle to make sure it is secured.

The buckle **MUST NOT** pull out.

continued on next page

4

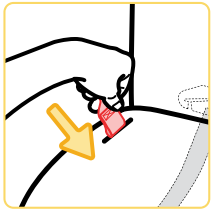

Thread Harness Strap

With the sewn end of the harness strap loop facing the buckle, thread the harness strap down through the hip harness slot.

5

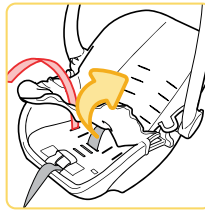

Pull Up Front of Seat Pad

6

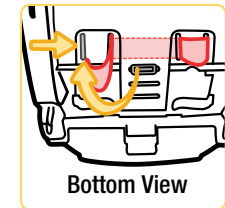
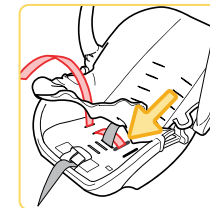
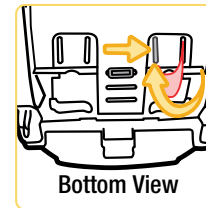

Turn Car Seat Over

Weave the harness strap in and out of car seat as shown.

7

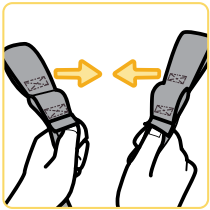

Make Harness Strap Even

The sewn ends of the harness strap loops **MUST** face each other.

8

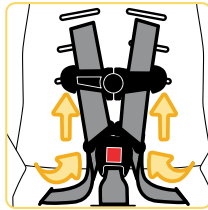

Thread Buckle & Chest Clip

The harness strap ends go through the **back** of the buckle on tongues and through the chest clip **front to back** as shown.

9

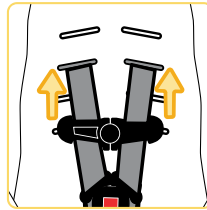

Thread Harness Straps into Correct Shoulder Harness Slots for Your Child

For [Rear-Facing Child Fit](#), see page 12.

10

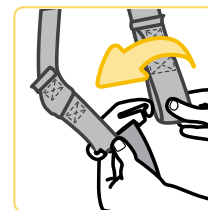

From Back of Car Seat, Attach 1st Harness Strap Loops to Splitter Plate As Shown

i

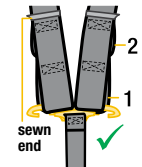

The sewn ends of the harness strap loops **MUST** face towards you.

DO NOT twist the harness strap or the harness adjustment strap.

Make sure the same harness strap loops are fitted completely on both sides of the splitter plate.

LATCH: Lower Anchor Belt

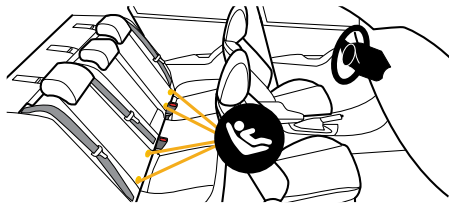

Your vehicle's features may be considerably different than those pictured here.

The lower anchors of **LATCH** (Lower **A**nchors and **T**ethers for **C**hildren) is a universal system for installing car seats without using vehicle seat belts. The LATCH: lower anchor belt can **ONLY** be used in vehicles that have the lower anchor bars installed in designated seating positions. Most vehicles manufactured after September 2002 are equipped with LATCH: lower anchor bars. Check your vehicle owner's manual to see which seating positions may be equipped with LATCH: lower anchor bars.

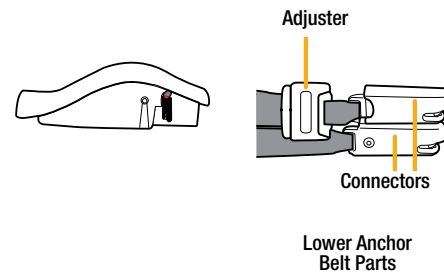

To Remove Lower Anchor Belt from Vehicle's Lower Anchor Bars

1. Lift the Lockoff to allow the LATCH belts to loosen.
2. Press the red release button on each connector.
3. Pull the connectors out of the vehicle seat.

WARNING:

DO NOT use both the lower anchor belt and vehicle belt at the same time.

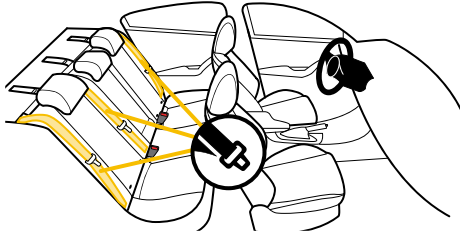

Your vehicle's features may be considerably different than those pictured here.

If LATCH: lower anchors are not an option you **MUST** use the vehicle seat belt system to install the car seat.

Not all vehicle belts and seating positions will work with car seats. Please go through the following steps to understand how to lock a car seat with a vehicle belt.

1

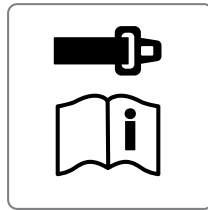

You **MUST** Review Your Vehicle Owner's Manual

Your vehicle owner's manual will let you know which vehicle belts and seating positions car seats can be installed in.

2



Check How This Car Seat Will Be Locked Into Place

The vehicle belt **MUST NOT** loosen after tightening.

This means there needs to be a way to lock the vehicle belt.

The ways to lock a vehicle belt are:

- By using this base's Lockoff, see page 8; **OR**
- By using the seat belt's retractor, see step 4; **OR**
- By using the seat belt's latch plate, see step 5.

continued on next page

3

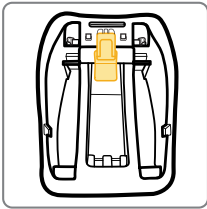

Lockoff

When used correctly, this base's Lockoff will lock the vehicle belt. You **MUST** also lock the vehicle belt using the retractor or latch plate. See step 4.

Please go to the vehicle belt with base installation section of the manual to see how to properly use this feature.

Vehicle Belt with Base Install | Page 18

When used correctly, this base's Lockoff will lock the vehicle belt. You **MUST** also lock the vehicle belt using the retractor or latch plate. See step 4.

If you will be installing without the base, you **MUST** lock the vehicle belt using the retractor or latch plate; continue to step 4.

4

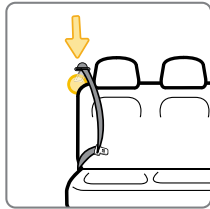

Check Retractor

Retractors pull seat belts into stored positions and lock the belt to hold passengers in place.

See the next page for some common types of vehicle belt retractors that will work with this car seat.

Types of Retractors



Switchable Retractor (most vehicles have this type)

This retractor can be switched to a locking mode.

You **MUST have the retractor in the locking mode** to use the seat belt with this car seat.

Switching to locking mode: Slowly pull the shoulder belt all the way out, then let it go back in **1-2 in.** (2.5-5 cm).

As it goes back in, you will most likely hear a ratcheting sound.

Gently pull the belt to see if it has locked. You will not be able to pull any more belt out if the lock has engaged.



Automatic Locking Retractor

This retractor always locks.

It will automatically lock after slowly pulling the seat belt out at least halfway and letting the belt go back into the retractor **1-2 in.** (2.5-5 cm).



Emergency Locking Retractor

See Step 5 "Check Latch Plates"

If the retractor does not lock, it is most likely an Emergency Locking Retractor. These retractors only lock during a sudden stop or collision.

You will need to determine if your seat belt's latch plate can lock the belt. See step 5, "Check Latch Plates".

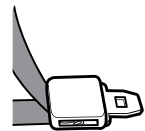

Locking Latch Plate

5



Emergency Locking Retractor with a Sliding Latch Plate

Check Latch Plates

Latch plates are the part of the seat belt that goes into the buckle.

To see if the latch plate locks:

1. Buckle Vehicle Belt
2. Firmly Tug Lap Portion of Seat Belt While Pulling It Up

If the vehicle belt does not slide through the latch plate, it's locked.

If the latch plate slides up and down the vehicle belt, it is a **sliding latch plate**.

Sliding latch plates easily slip between the lap and shoulder portions of the belt.



If you have an Emergency Locking Retractor with a Sliding Latch Plate, you MUST use a locking clip.

Please contact us for one, see the back cover of the manual.

Never Use the Following With This Car Seat:

- Emergency Locking Retractor Lap Only Belt
- Inflatable Seat Belts

⚠ WARNING:

NEVER take your child out of the child restraint while the vehicle is moving.

NEVER leave your child unattended. Placing your child in a hot child restraint may result in burns.

DO NOT use a child restraint with damaged or missing parts.

DO NOT use a child restraint with cut, frayed, or damaged harnesses.

DO NOT substitute parts or try to modify the child restraint in any way. **DO NOT** lubricate buckles and fasteners.

DO NOT use any child restraint accessory except those approved by Dorel Juvenile Group.

NEVER allow any child to play with this child restraint; it is not a toy.

DO NOT remove or cover up any of the warning labels or other labels on the child restraint.

This child restraint has been certified for use in passenger vehicles. **DO NOT** use in a boat, on a motorcycle or in a cargo van or bus where there are no seat belts or tether anchors.

Read all instructions for additional warnings.

WARNING:

NEVER place a child rear-facing in a seating position with an active frontal air bag.

Check the vehicle owner's manual for more information about air bag/child restraint use.



Use the child restraint only on vehicle seats that face forward.



DO NOT use on seats that face the sides or rear of the vehicle.

For vehicles without a back seat, refer to your vehicle owner's manual.



Children are safer when properly restrained in rear seating positions than in the front seating positions.

According to accident statistics, children in rear seating positions are statistically safer, whether you have air bags, advanced air bags, or no air bags at all.

If you are not sure where to place the car seat in your vehicle:

- Consult your vehicle owner's manual; **OR**
- Contact Dorel Juvenile Group Consumer Care Department; **OR**
- Visit your local Child Passenger Inspection Station. Go to <https://www.nhtsa.gov/equipment/car-seats-and-booster-seats> to find your closest station.

WARNING:

Check the vehicle belt or lower anchor belt before each use. Use only if the belt can be tightened properly and locked securely in place.

Even when unoccupied, this child restraint **MUST** be firmly secured to the vehicle with the lower anchor belt or with the vehicle seat belt.

Even when unoccupied, this booster seat **MUST** be firmly secured to the vehicle with the vehicle seat belt.

In a crash or sudden stop, an unsecured child restraint or booster seat could injure occupants.

To avoid your child being seriously burned, take the following precautions:

- Park in the shade or where the sun does not directly hit the car seat.
- Cover the car seat with a sheet or blanket when not in use.
- Check for hot seat and buckles before placing child in car seat.

To help protect your vehicle seat's upholstery from damage: you may use an accessory approved by Dorel Juvenile Group or a single layer towel underneath and behind car seat.

Replacement & Expiration

DO NOT risk your child's safety.

To keep your child as safe as possible, Dorel Juvenile Group strongly recommends replacing the car seat even after a minor crash; even if it was not occupied at the time.

Replacement After a Minor Crash

The National Highway Traffic Safety Administration states that for a crash to be considered minor **ALL of the following MUST be true:**

- Vehicle able to drive away from the crash site; **AND**
- Vehicle door nearest the car seat was not damaged; **AND**
- No passengers were injured; **AND**
- Airbags did not deploy; **AND**
- There is no visible damage to the car seat.

If the crash your car seat was involved in meets **ALL** the criteria, you may not need to replace the car seat.

If one or more of these criteria are not true or if you are uncertain of any of your answers, replace the car seat immediately.

Replacement After a Moderate to Severe Crash

You **MUST** replace this car seat if it has been in a moderate to severe car crash.

This car seat is intended to protect a child in a single crash. During a crash, the car seat and all of its parts absorb crash energy which can deform or weaken it. Damage is not always visible. A damaged car seat **MUST** be replaced immediately.



Expiration

On the side of the car seat there is a date of manufacture label as shown.

DO NOT use this car seat more than 10 years after the date of manufacture.

Registration & Safety Notices

Please complete the postage-paid registration card that came with your child restraint, and send it to us.

Child restraints could be recalled for safety reasons.

You must register this restraint to be reached in a recall.

Send your name, address, e-mail address if available and the restraint's model number and manufacturing date to:

Dorel Juvenile Group
2525 State Street
Columbus, IN 47201

or call 1-800-544-1108 or register online at <https://www.safety1st.com/registration>.

For recall information, call the U.S. Government's Vehicle Safety Hotline at 1-888-327-4236 (TTY: 1-800-424-9153), or go to www.NHTSA.gov.

Example of model number, manufacture date, and line code.

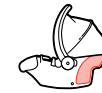

If you don't have the card or if your address changes, you will find the model number, manufacture date, and line code on the label located on the side of the car seat.

This restraint is certified for aircraft use.



Rear-Facing Aircraft Installation

Follow the steps on pages 28-32.

Install the car seat in a window seat to avoid blocking the aisle. If the aircraft lap belt is too short, ask the flight attendant for a belt extender.

Use only on forward-facing aircraft seats. Contact the airline for their specific policies.

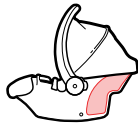

Some airlines may ask to see a label stating that this car seat is certified for aircraft use.

There is an airplane certification label located on the side of this car seat as shown.

Dorel Juvenile Group, Inc. (DJG) warrants this product to the original retail purchaser as follows: This product is warranted against defective materials or workmanship for one year from the date of original purchase.

An original receipt is required to validate your warranty.

DJG will, at its option, provide replacement parts or replace this product. DJG reserves the right to substitute if the part or model has been discontinued.

To make a claim under this warranty, please contact our Consumer Care Department by phone: 1-800-544-1108 or text: 1-812-652-2525. Our hours of operation are from 8:00 a.m. to 6:00 p.m. EST Monday through Thursday and from 8:00 a.m. to 4:30 p.m. on Friday.

Proof of purchase is required and shipping charges are the responsibility of the consumer.

Warranty Limitations: This warranty does not include damages which arise from misuse or abuse of this product.

Limitation of Damages: The warranty and remedies as set forth are exclusive and in lieu of all others, oral or written,

expressed or implied. In no event will DJG or the dealer selling this product be liable to you for any damages, including incidental or consequential damages, arising out of the use or inability to use this product.

Limitation of warranties and other warranty terms and state law rights: Any implied warranties, including implied warranties of the merchantability and fitness for a particular purpose, shall be limited to the duration and terms of the express written warranty.

Some states do not allow limitations as to how long an implied warranty lasts or the exclusion or limitation of incidental or consequential damages, so the above limitations may not apply to you.

This warranty gives you specific legal rights, and you may have other rights, which vary from state to state.

Neither DJG nor the dealer selling this product authorized any person to create for it any other warranty, obligation, or liability in connection with this product.