

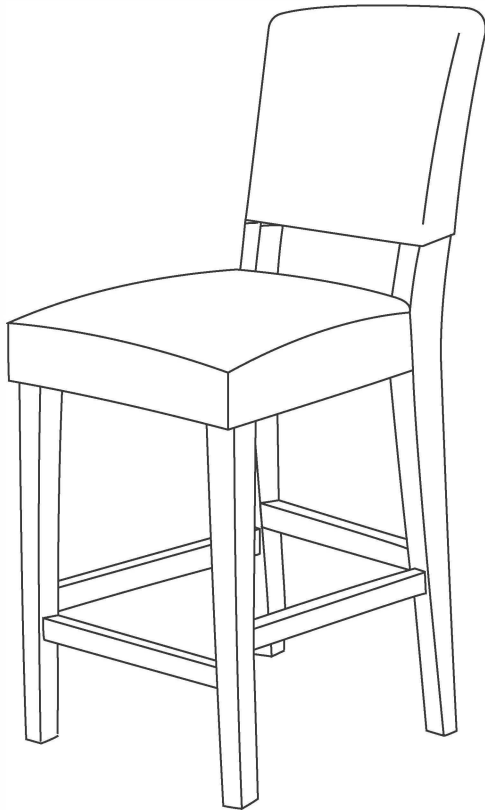

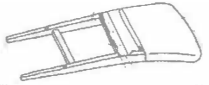







Assembly Instructions, # 214940

Upholstered Back 24" Counter Height Stool



A: Chair Back	
B: Seat Pad	
C: (2) Side Stretchers L & R	
D: Front Stretcher	
E: (2) Front Legs	
G: (4) AllenBolts 1/4' x 40	
H: (4) AllenBolts 1/4' x 60	
I: (6) Screws 4 x 50	
J: Allen Wrench	
K: Glue	
L: (4) Shoes	

Step 1

Fasten the seat frame onto chair back. Do not tighten.

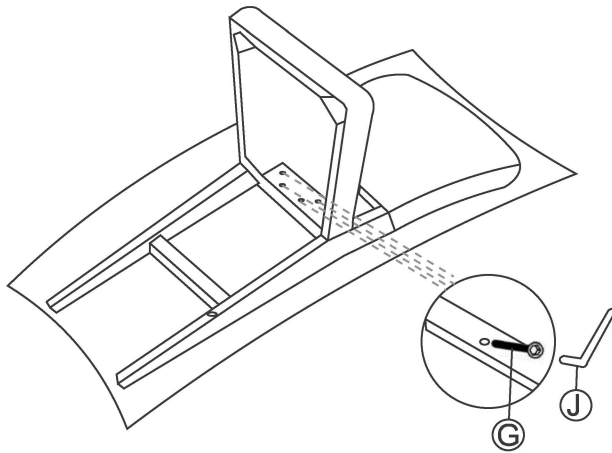

Step 2

Place the chair assembly upside down on a table. Insert two side stretchers with glue into back leg holes. Tighten bolts when all stretchers are in place and all legs are properly leveled.

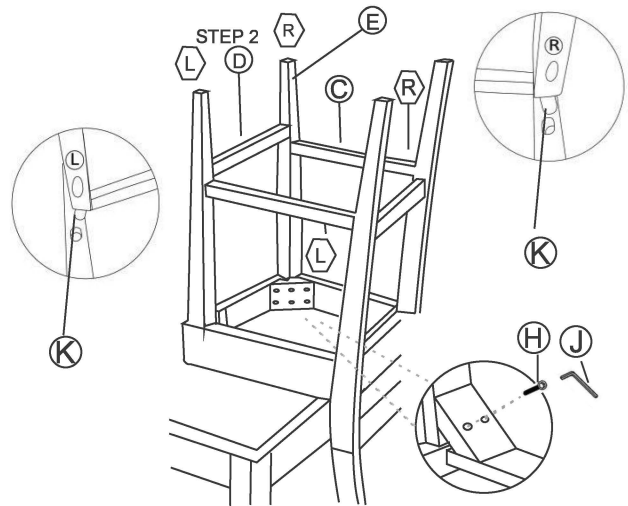

Step 3

Fasten the stretchers and legs with screws.

