

Features

- Quick-Release™ functionality allows seat to be removed easily from toilet for convenient cleaning
- Quick-Attach® hardware for fast and secure installation
- Color-matched plastic hinges

Material

- Plastic construction

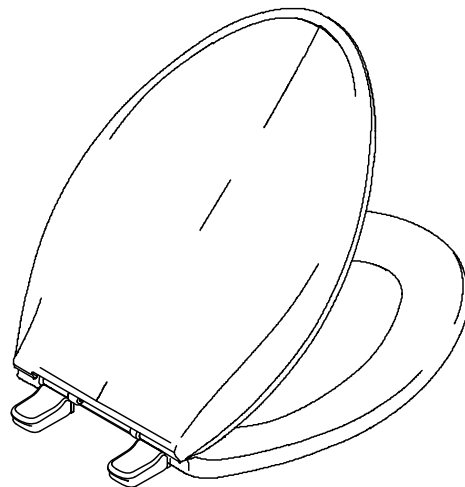

Codes/Standards









None Applicable

KOHLER® One-Year Limited Warranty

See website for detailed warranty information.

Available Colors/Finishes

Color tiles intended for reference only.

Color	Code	Description
	0	White
	47	Almond
	55	Innocent Blush™
	6	Skylight
	45	Wild Rose™
	52	Navy
	53	Raspberry Puree
	71	Seafoam Green
	89	Desert Bloom

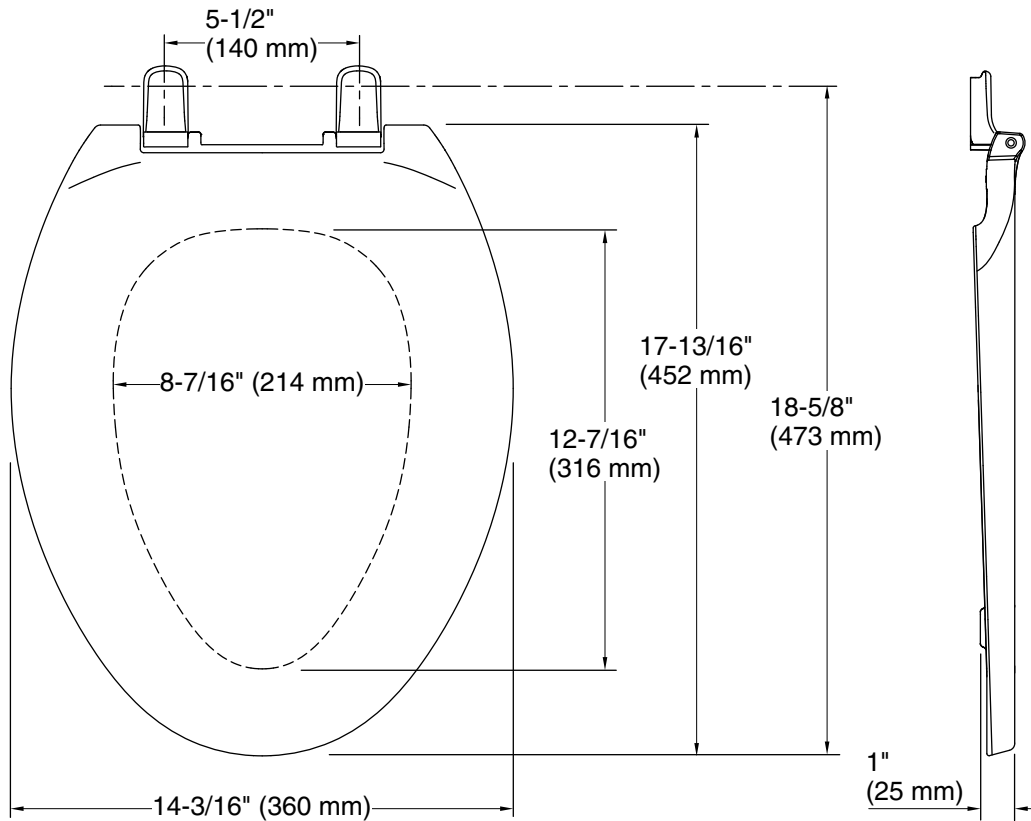

Technical Information

All product dimensions are nominal.

Seat shape type: Elongated
Seat front type: Closed-front
Seat-mounting holes: 5-1/2" (140 mm)

Notes

Install this product according to the installation instructions.

Pressure/fixture Supply Requirements