

ITEM# 83386

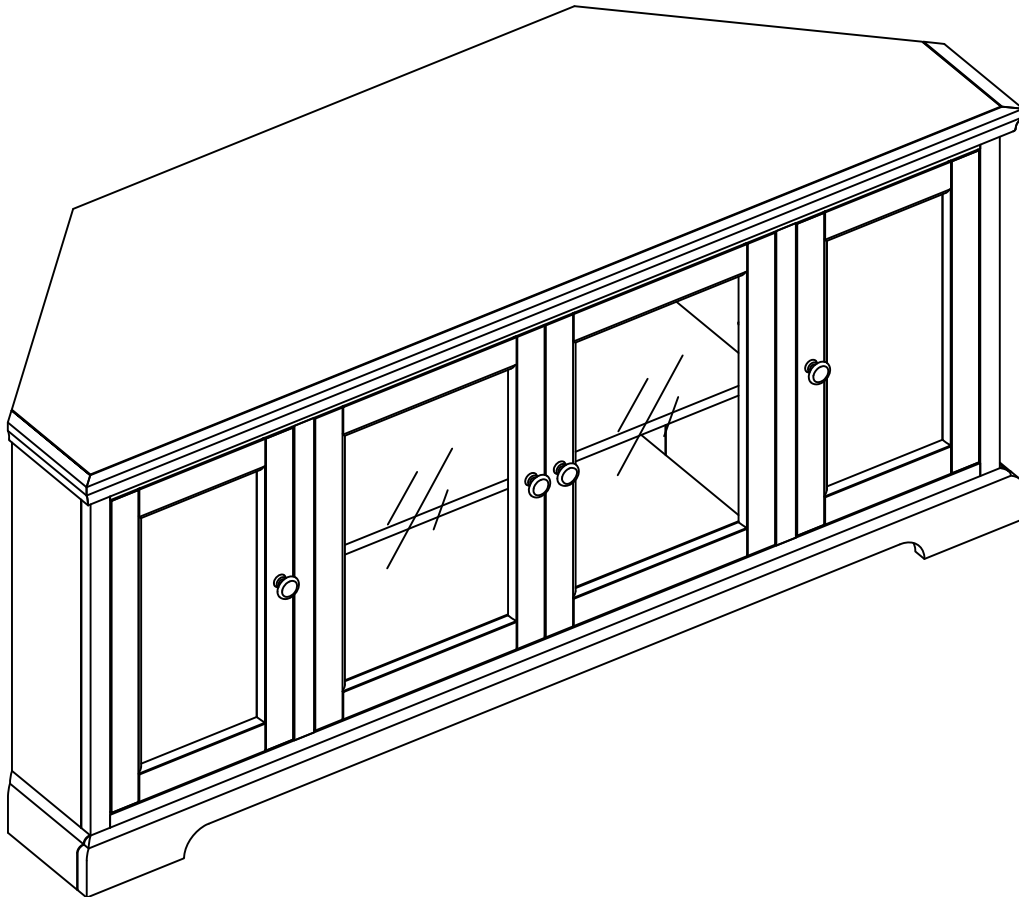



Slate Black 25" H, 56" W Corner W/Storage

Leick
Home
SINCE 1910

2219 S. 19th St.
Sheboygan, WI 53081
Ph: 920-451-4060
Fax: 920-451-4063
info@leickfurnituresince1910.com

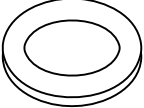
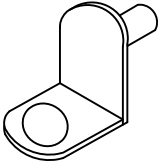
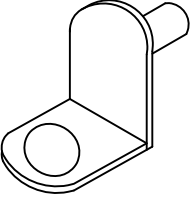
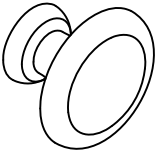

Hardware List

Item	Description	Qty
a	 Bolt 1/4" * 1-1/8"	4PCS
b	 Allen wrench	1PC
c	 Washer 1/4" * 12mm	4PCS
d	 Shelf metal clip	12PCS
e	 Bigger Shelf metal clip	2PCS
f	 Door Pull	4PCS
g	 Machine screw for door pull 5/32" * 3/4"	4PCS

Parts List

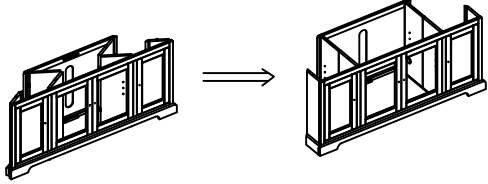
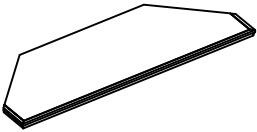
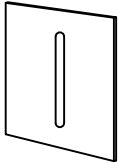
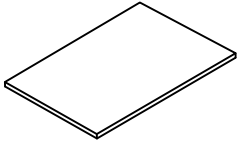
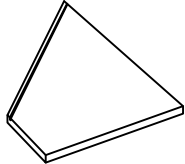
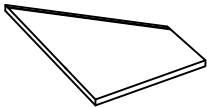
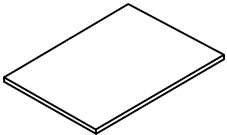
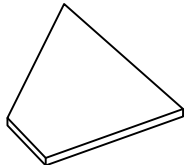
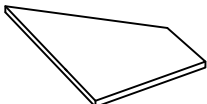
Item		Description	Qty
A		Cabinet	1PC
B		Top Panel	1PC
C		Side Back Panel	2PCS
D		Middle Bottom Panel	1PC
E		Left Side Bottom Panel	1PC
F		Right Side Bottom Panel	1PC
G		Middle Adjustable Shelf	1PC
H		Left Side Adjustable Shelf	1PC
I		Right Side Adjustable Shelf	1PC

Assembly Instructions

Two person assembly recommended.

step 1

Unfold Cabinet.

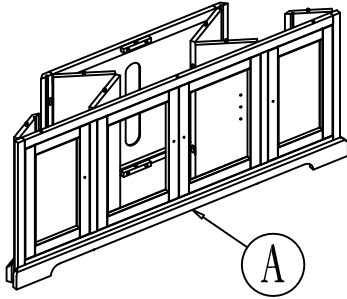

step 2

Install two bigger shelf clips on the side bottom.

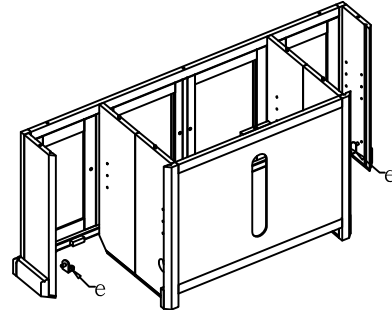

step 3

Open 4 doors. Insert the center bottom panel first, then insert the side bottom panel.

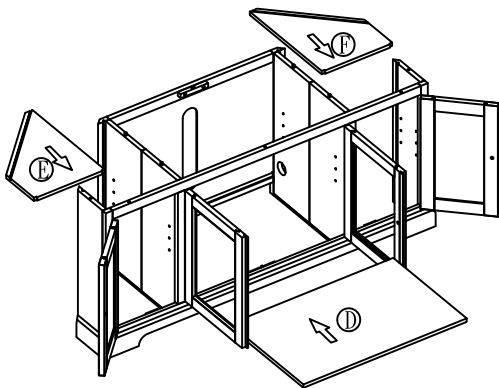

step 4

Insert two side back panels.

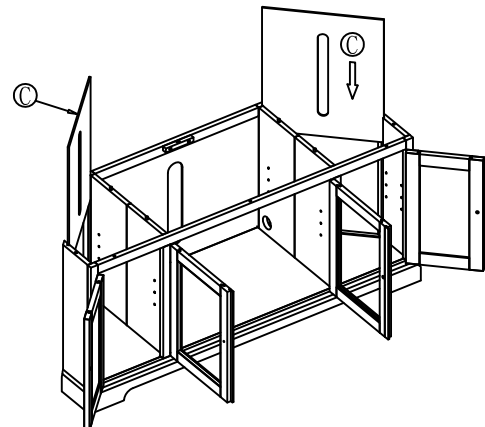

step 5

Bolt on top with 4 bolts.
DO NOT OVER TIGHTEN.

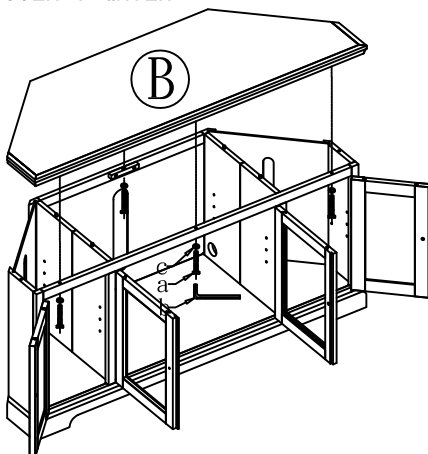

step 6

Install shelf clips and insert shelves and door pulls.

