

Features

- Left-hand trip lever
- For use with the Memoirs Comfort Height® toilet
- Coordinates with other products in the Memoirs collection

Material

- Premium metal construction for durability and reliability
- KOHLER finishes resist corrosion and tarnishing

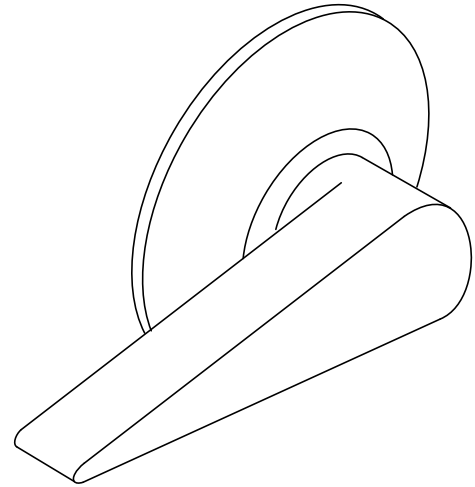

ADA

Codes/Standards

ASME A112.18.1/CSA B125.1

ADA









ICC/ANSI A117.1

KOHLER® One-Year Limited Warranty

See website for detailed warranty information.

Available Colors/Finishes

Color tiles intended for reference only.

Color	Code	Description
	SN	Vibrant® Polished Nickel
	AF	Vibrant® French Gold
	BN	Vibrant® Brushed Nickel
	BV	Vibrant® Brushed Bronze
	BL	Matte Black
	2MB	Vibrant® Brushed Moderne Brass
	BGP	Vibrant Brushed Graphite
	DR	Deep Bronze
	TT	Vibrant Titanium

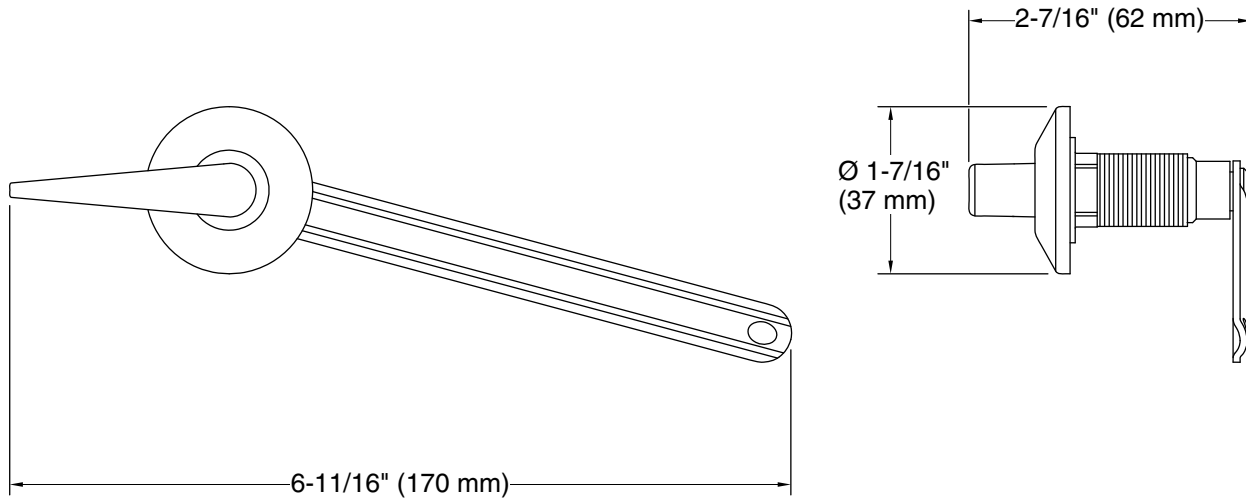

Technical Information

All product dimensions are nominal.

Material: Metal

Notes

ADA compliant when installed to the specific requirements of these regulations.