

Commercial Pressure Balance Trim C
 Finishes : **chrome** Part no. : **04212000**



Description

Features

- Flow: 4.5 GPM (17 L/Min)
- Integrated bypass for use with diverter tub spouts
- Temperature and on/off control for 1 outlet

Item details

List Price \$ 150.00

Compliance

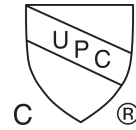

Product image



Scale drawing

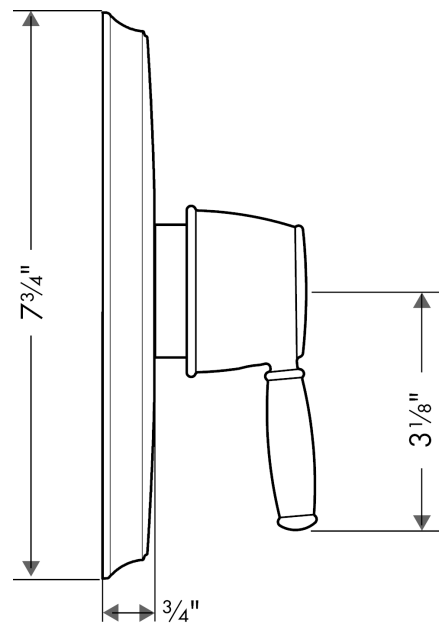

Commercial
Pressure Balance Trim C
Finishes : **chrome** Part no. : **04212000**



Exploded drawing

Year of production: >10/08

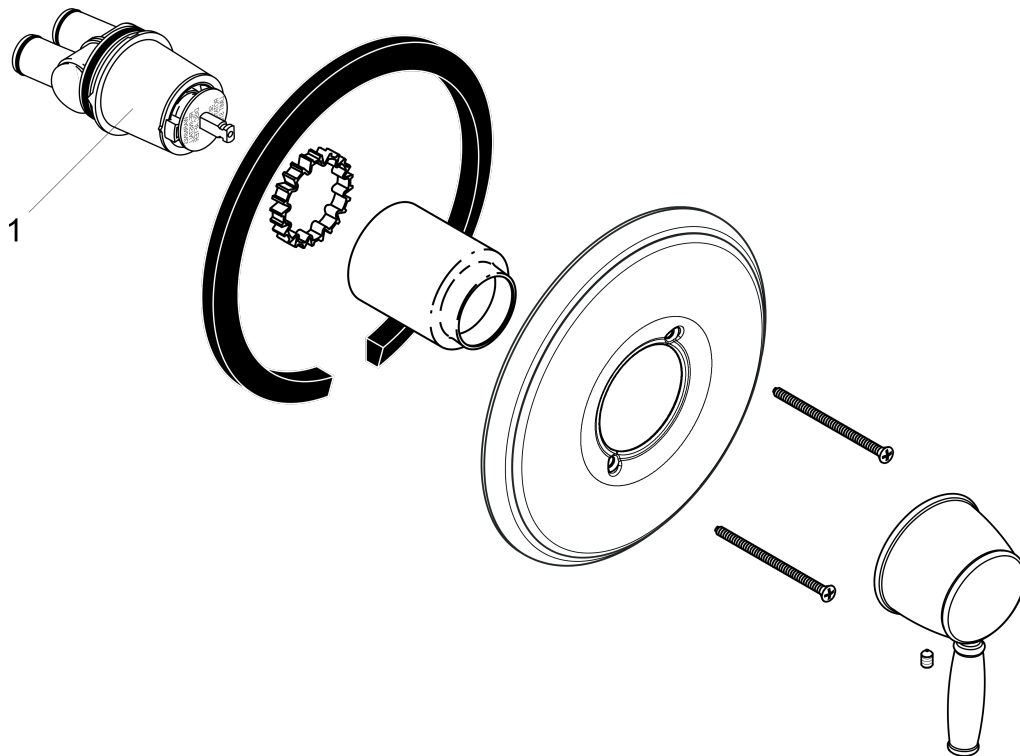

Commercial
Pressure Balance Trim C
 Finishes : **chrome** Part no. : **04212000**



Spare parts list

Year of production: >10/08

Pos.	Description	Part no.	Price	PU
1	cartridge, assy	88727000	-	1
a	base body	04120181	-	1
b	base body	04121181	-	1