

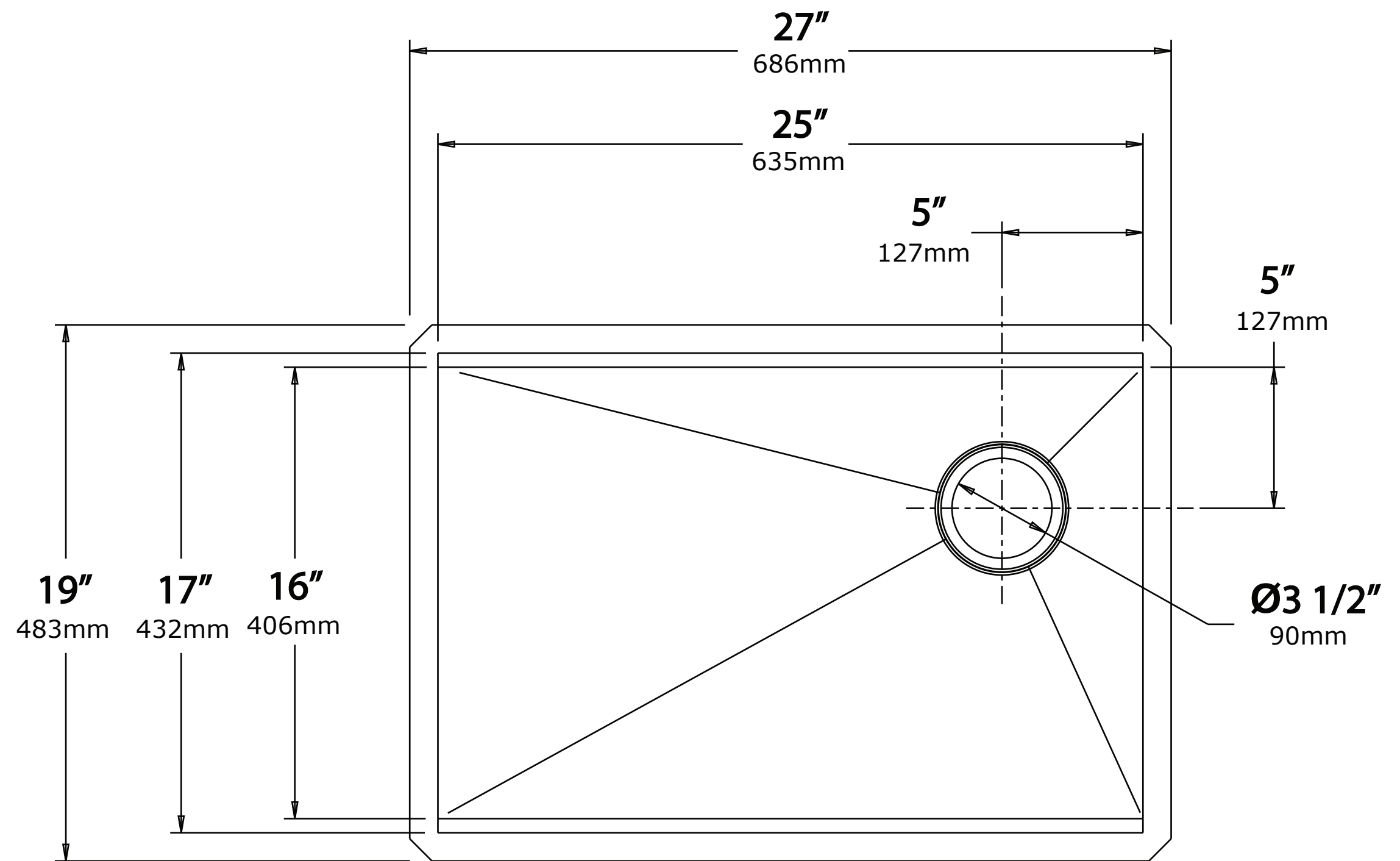

**Model No.
KWU110-27**

Undermount Cut-out

**Pro Hotline: 516.801.8955
Customer Service: 800.775.0703**



NOTE: Cutout template is provided as a guide **ONLY** and must be checked against actual sink to verify correct fit.

Please tear perforated edge for zero / flushed reveal →

Please use outer edge for positive reveal 3/8" →