

A

x1 Headboard
x1 Tête de lit
x1 Cabecera



B

x1 Left Leg *
x1 Patter gauche
x1 Pata izquierda

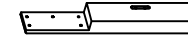

C

x1 Right Leg *
x1 Patter de droite
x1 Pata derecha

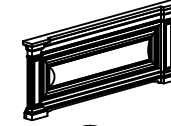

D

x1 Footboard
x1 Pied de lit
x1 Panel de pie de cama



E

x2 Side Rail
x2 Traverse
x2 Travesano lateral

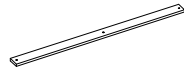

F

x5 Slats *
x5 Lattes
x5 Listones



G

x5 Center Supports *
x5 Supports centraux
x5 Soportes centrales

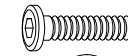

H

x10 Bolt Ø1/4" x 40 mm *
x10 Vis à tête creuse hexagonale
Ø1/4" x 40 mm
x10 Perno Allen Ø1/4" x 40 mm



K

x10 Lock washer Ø1/4" *
x10 Rondelle de blocage Ø1/4" *
x10 Arandela de seguridad Ø1/4" *



I

x10 Flat Washer Ø1/4" x 19mm *
x10 Rondelle de plate Ø1/4" x 19mm
x10 Arandela plana Ø1/4" x 19mm



J

x1 Allen Key 4mm *
x1 Clé hexagonale 4mm
x1 Llave allen 4mm

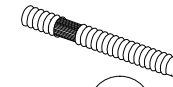

T1

x8 Hanger Bolt Ø5/16" x 89mm *
x8 Boulon-vis Ø5/16" x 89mm
x8 Perno de suspensión Ø5/16" x 89mm



T2

x8 Hex Nut Ø5/16" *
x8 Écrou hexagonal Ø5/16" *
x8 Tuerca hexagon Ø5/16"



T3

x8 Lock washer Ø5/16" *
x8 Rondelle de blocage Ø5/16" *
x8 Arandela de seguridad Ø5/16" *



T4

x8 Flat Washer Ø5/16" x 14mm *
x8 Rondelle de plate Ø5/16" x 14mm
x8 Arandela plana Ø5/16" x 14mm

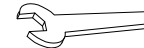

T5

x1 Open Wrench Ø5/16" *
x1 Clé à fourche Ø5/16" *
x1 Llave de boca Ø5/16"



T6

x10 Screw M4 x 32 mm *
x10 Vis M4 x 32 mm
x10 Tornillo M4 x 32 mm

* Replaceable Part

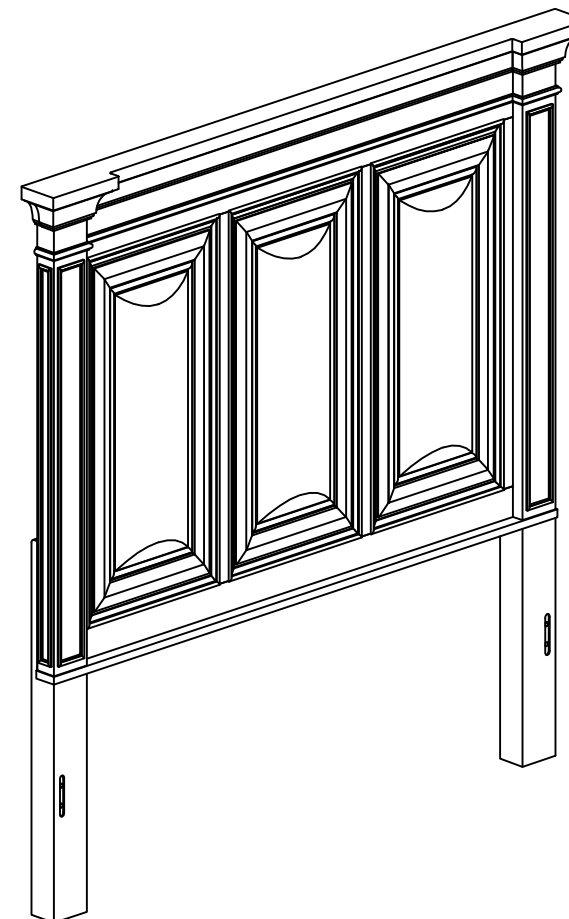
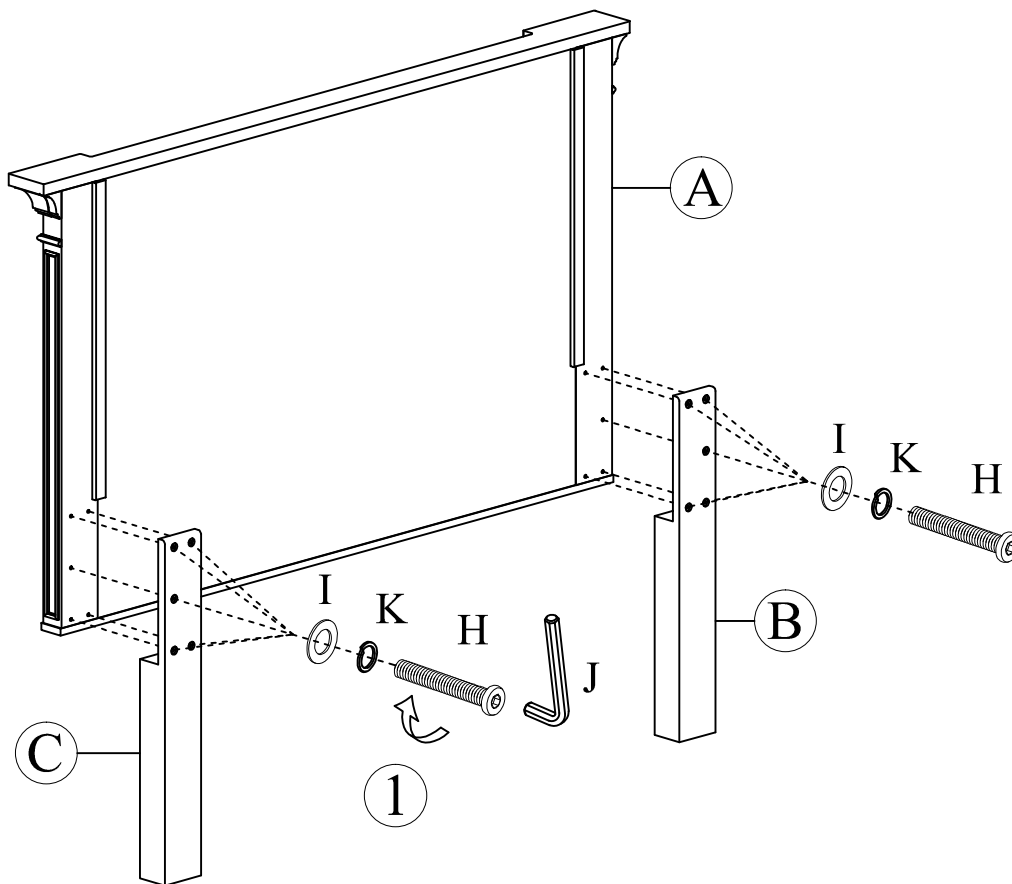

* Replaceable Part

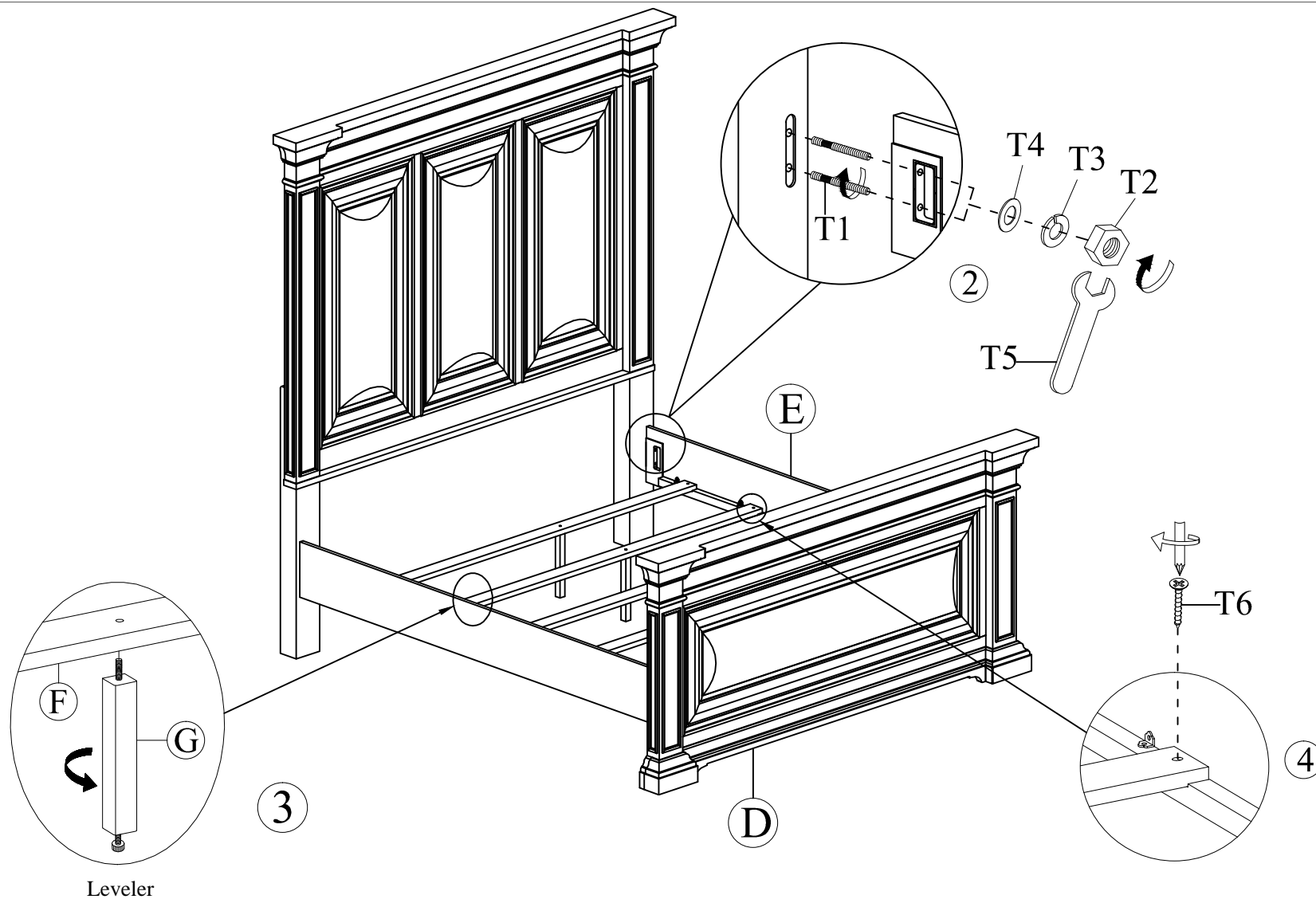

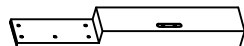
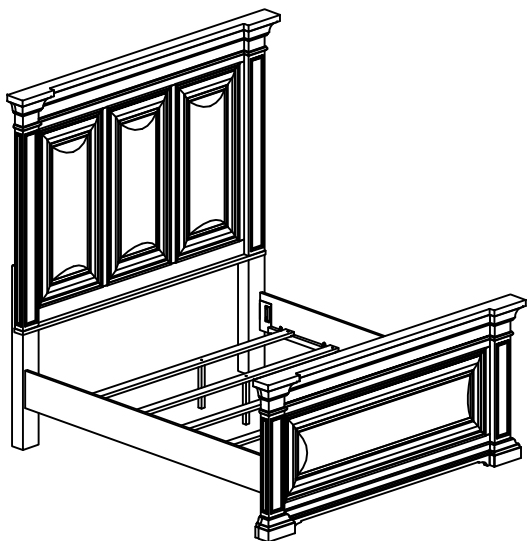

x1 RP351170-LEGL
Left Leg *
Patter gauche
Pata izquierda

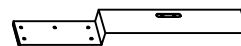

x1 RP351170-LEGR
Right Leg *
Patter de droite
Pata derecha

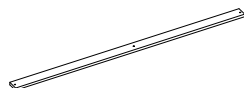

x 5 RP351171-SLAT
Slat *
Lattes
Listones

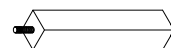

x5 RP351171-SULEG *
Center Leg
Pattes centrales
Patas centrales

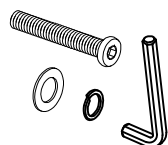

x1 RP351170-HWKIT
Hardware Kit *
Kit de matériel
Kit de hardware



x10 RP351171-SCREW
Screw *
Vis
Tornillo

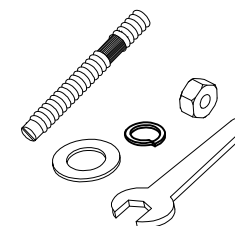

x1 RP351172-HWKIT
Hardware Kit *
Kit de matériel
Kit de hardware

* Replaceable Part