

R51 ou/or R51-EX ou/or R51-SPEX

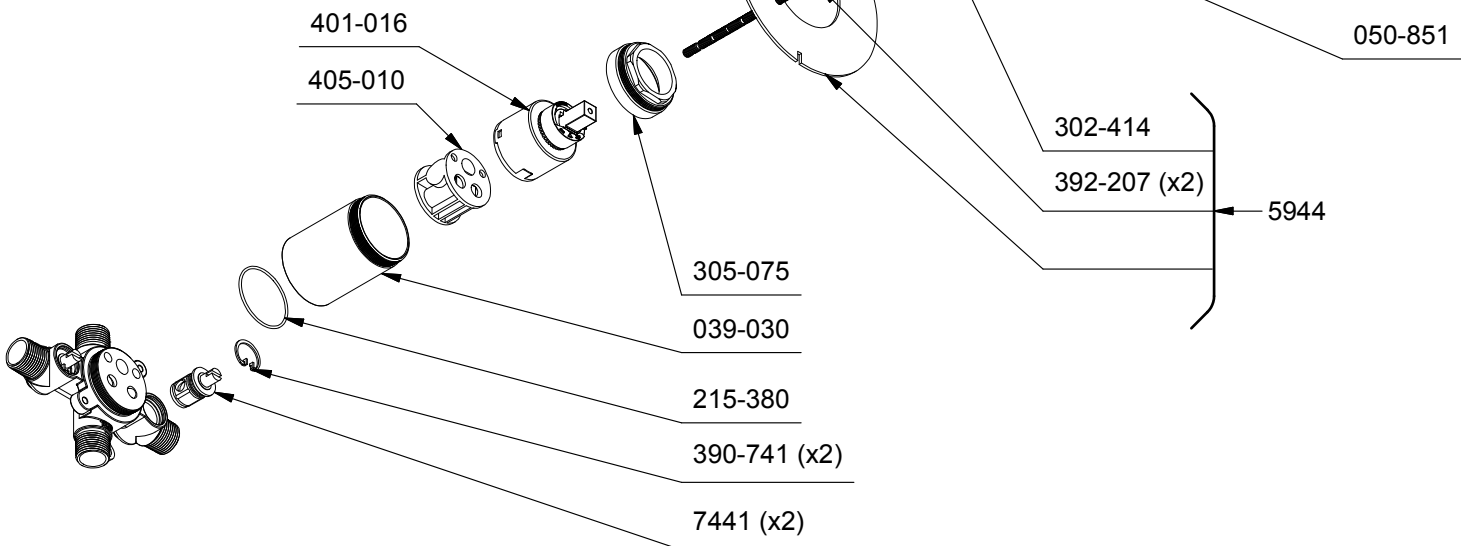
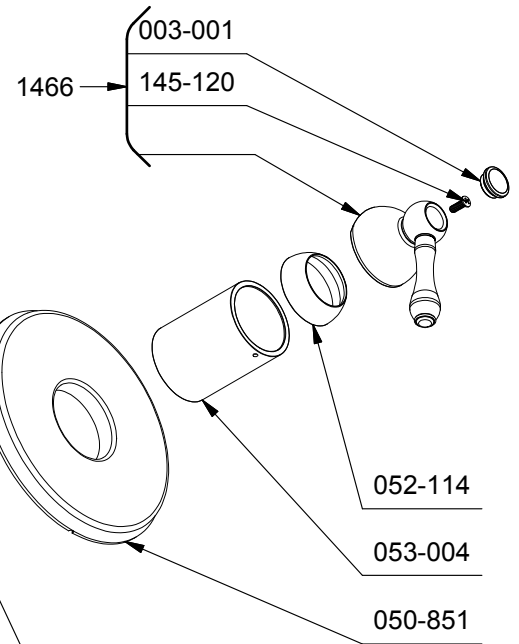
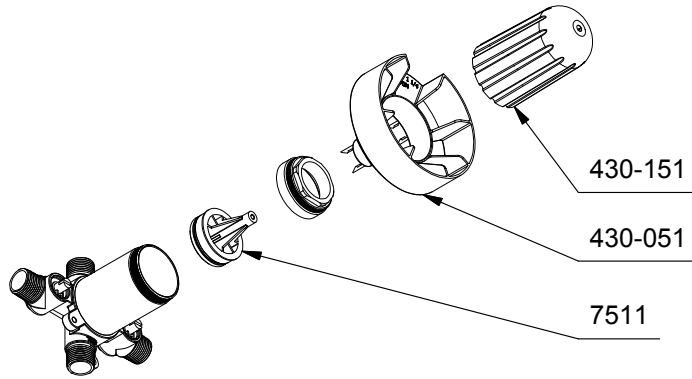

*Les dimensions, les modèles et les finis présentés peuvent différer. / Sizes, models and finishes may differ from those presented.