

# SIMPLIHOME®

## Madalyn / Dorothy / Gia

---

### Dining Arm Chair (Set of 2)

MODEL # AXCMADDAC-NL

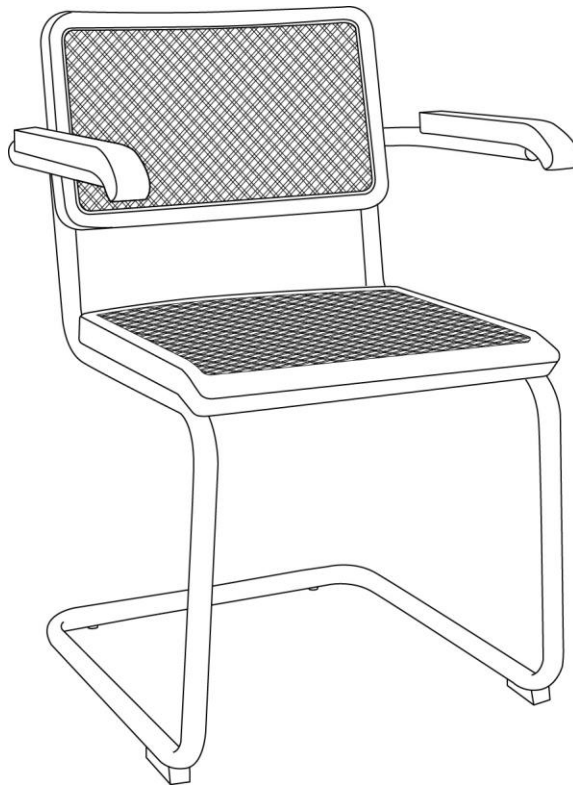

brooklyn + max™

Wynden+Hall™  
HOME DECOR

# SIMPLIHOME®

## Great quality is a right.

Thank you for shopping with Simpli Home,  
America's top brand for high-value furniture.



## It's time to register your product warranty.

It's quick and easy. And you'll be happy you did.

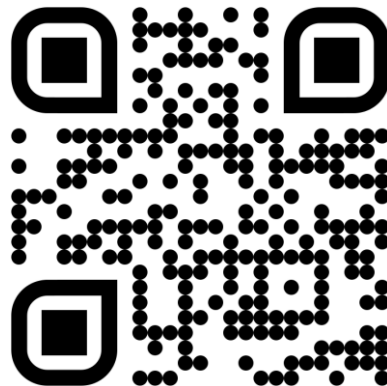

- ✓ Activate your **1-year** warranty.
- ✓ Automatic entry to win a **\$500** gift certificate.
- ✓ Earn instant rewards and **save**.

[simpli-home.com/product-registration](https://simpli-home.com/product-registration)

# SIMPLIHOME®

## Review your product and collect rewards!

Thank you for your purchase! We hope you enjoy it. We'd love your feedback. Please share a review and get instant rewards!



[simpli-home.com/product-review](https://simpli-home.com/product-review)



## Share photos and get your cash back!

Send us images or share them on social and qualify for instant rewards. You may even receive store credit on your entire purchase!

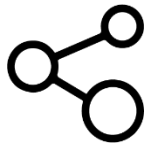
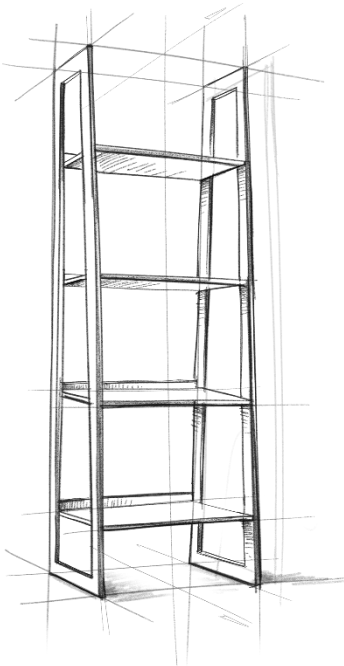

[simpli-home.com/share-images](https://simpli-home.com/share-images)

# SIMPLIHOME®

## For fastest customer service:



1. Open your phone's camera.
2. Point your phone's camera at the QR code to scan.
3. Click on the pop up.
4. You'll be taken to our customer service page.
5. Fill the form with your order information and issue.
6. Submit form.
7. A customer service associate will contact you.

## Other ways to contact us...



### Email Us

customerservice@simpli-home.com



### Visit Us

Visit our site directly at  
[www.simpli-home.com](http://www.simpli-home.com)



### Call Us

1-866-518-0120  
Monday to Friday  
9am to 5pm EST

**\*If you've purchased from a retailer and you wish to return the product, please contact the retailer directly.**

**IMPORTANT:** Please read this manual carefully before beginning assembly of this product. Keep this manual for future reference.

## Safety Information

**This furniture is designed for indoor use.**

Identify all the parts and hardware. Do not discard of the packaging until you have checked that you have all the parts and hardware required. Hardware package may have spare parts.

**WARNING:** This item contains small parts which can be swallowed by children and pets. Keep children and pets away during assembly. To avoid danger of suffocation, always keep plastic bags away from children and pets.

We recommend that you assemble this unit on a carpeted floor to avoid scratches. If using power tools, set the tool to low torque to avoid damage.

**May require 2 people for ease of assembly.**

## Care & Maintenance

**This furniture is designed for indoor use.**

Perhaps the greatest environmental damage to wood furniture comes from wide swings in relative humidity (RH) in our homes. Wood absorbs and desorbs water as relative humidity rises and falls, and in doing so it swells and shrinks. Making matters worse, it expands and contracts unequally along different grain directions. As humidity changes, the components of wooden objects are continually pushing and pulling against each other. This pressure often results in parts of furniture no longer fitting together closely or becoming distorted or breaking from their own internal stresses.

The response to relative humidity changes begins with determining the annual average RH for your particular space. Then try to keep the RH in the space where your furniture is as close to that average as possible, generally within about 10% up or down. De-humidify in the summer and humidify in the winter.

Be aware that raising the temperature lowers the humidity and vice versa. Thus, modern heating systems, which can drive down interior RH in the winter, almost invariably cause problems for furniture. To counteract their effect, you can either modify the RH by keeping furniture containing spaces cooler in the winter or most importantly, have a good working humidifier for your home. A humidistat automatically works to balance the humidity in your home so it is constant. Dry indoor air can suck enough moisture from its surroundings to do permanent damage to wood, causing it to crack or split.

Remember, that not all woods are created equal. Two factors that help determine how rapidly a wood will lose moisture are pore size and surface hardness. A piece made from a dense and hard wood will dry less rapidly than pieces made from softer woods.

Furniture that is sealed and lacquered will lose moisture more slowly than an unfinished piece while pieces with veneer finishes are not only stronger but lose moisture more slowly than other finishes.

**To help protect your wood furniture, take these steps:**

- Use a humidifier, preferably one with an automatic control system that can sense the humidity level and adjust itself accordingly
- Don't over-humidify; that can damage wood by causing it to expand and contract
- Keep furniture out of direct sunlight, which can cause it to dry out, crack and warp
- If you can avoid it, don't put furniture near heating vents; if you can't, keep the item 3 to 4 inches away from the wall, giving the heat and air space to circulate
- Dust with soft dry cloth
- Do not use liquid or aerosol products
- To avoid marking, do not place rubber on surface (foot pads, etc.)
- For soil build-up, wipe with damp cloth and dry
- Do not use abrasive cleaners

**Part Description**

**A**

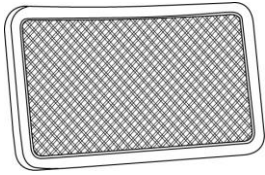

CHAIR BACK  
QTY 1

**B**

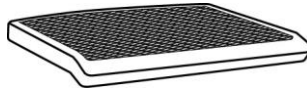

SEAT  
QTY 1

**C**



RIGHT LEG  
QTY 1

**D**

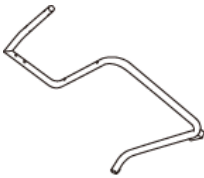

LEFT LEG  
QTY 1

**E**



ARMREST  
QTY 2

**F**

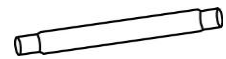

CONNECTOR BAR  
QTY 1

**Hardware Description**

**1**



ALLEN KEY SCREW  
M8 x 32 mm  
QTY 12

**2**



ALLEN KEY SCREW  
M6 x 12 mm  
QTY 2

**3**

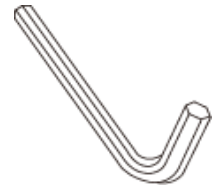

ALLEN KEY  
M8 x 80 mm  
QTY 1

**4**

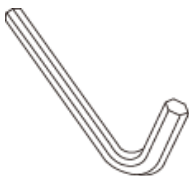

ALLEN KEY  
M6 x 70 mm  
QTY 1

Step 1

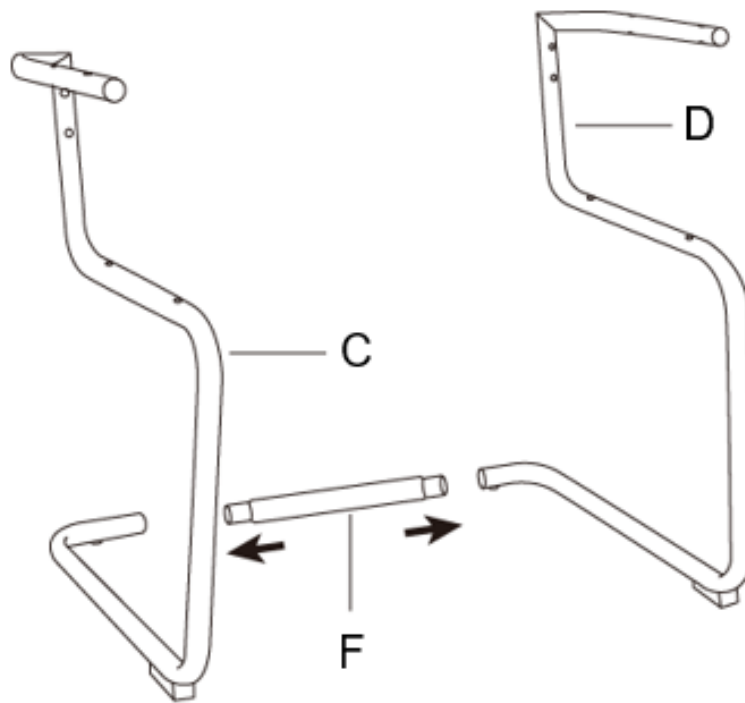

1. Place the Left Leg (D) and Right Leg (C) on a flat, smooth surface.
2. Connect the Left Leg (D) to the Right Leg (C) using the Connector Bar (E).



Step 2

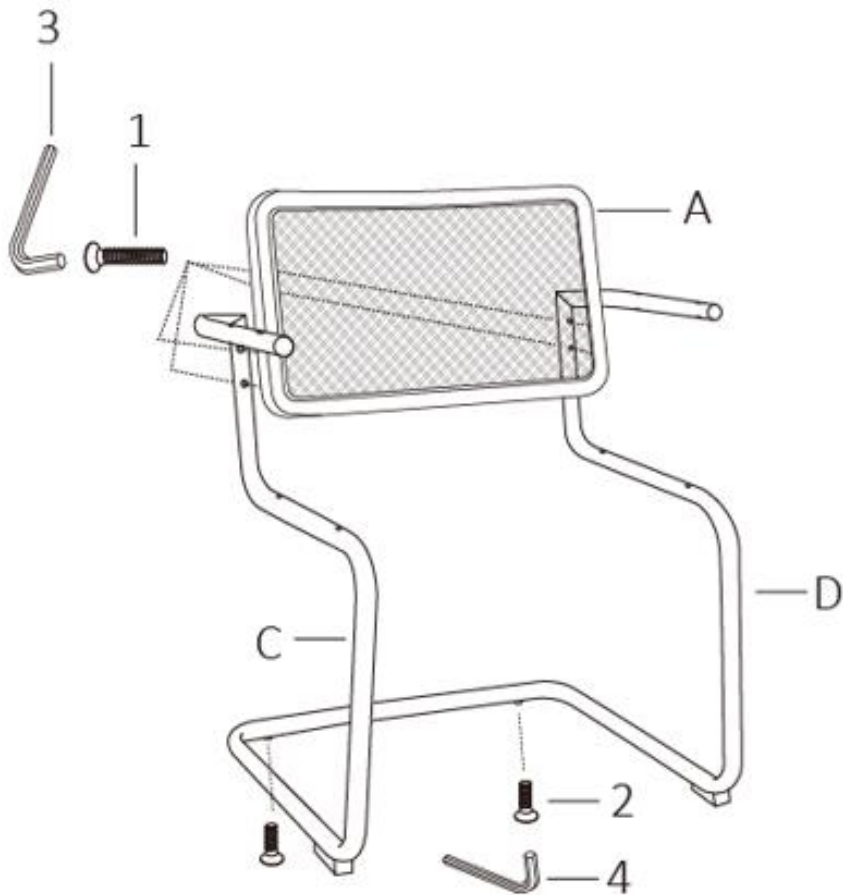

1. Use Allen Key Screws (2) to attach Legs (C) and (D) to Connector Bar (E) and use Allen Key (4) to tighten.
2. Attach Chair Back (A) to assembled Legs using Allen Screws (1) and use Allen Key (3) to tighten.

Step 3



1. Attach Seat (B) to assembled Legs using Allen Key Screw (1).
2. Use Allen Key (3) to tighten.

Step 4

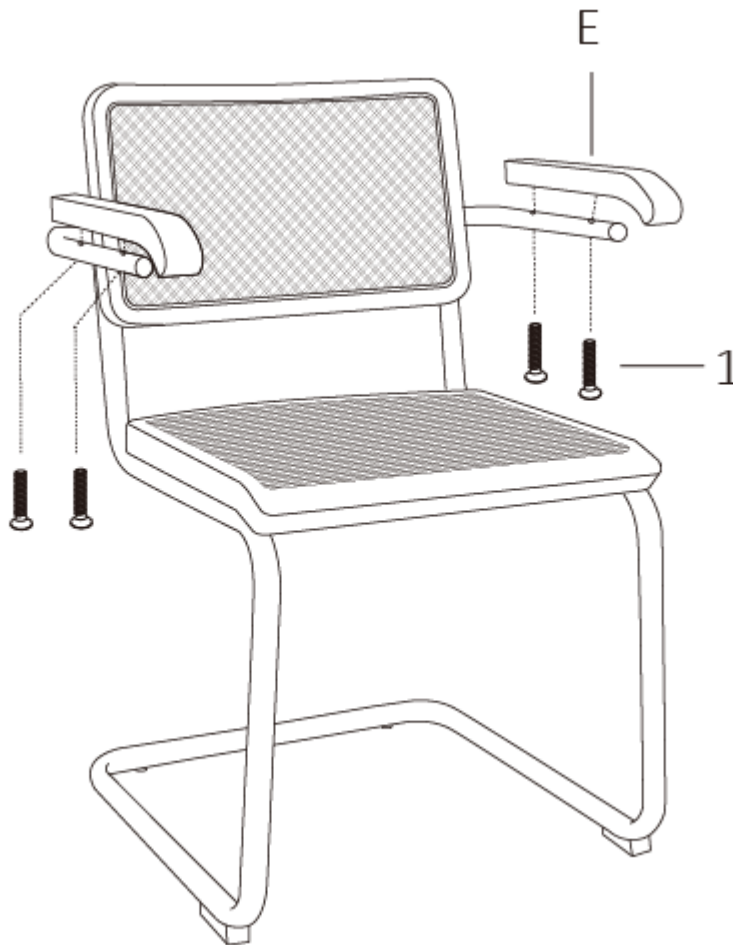

1. Attach Armrest (E) to the Leg frame arm using Allen Key Screws (1).
2. Use Allen Key (3) to tighten.