

OUTER clé BELGIAN REPRODUCTION: PRIVÉ

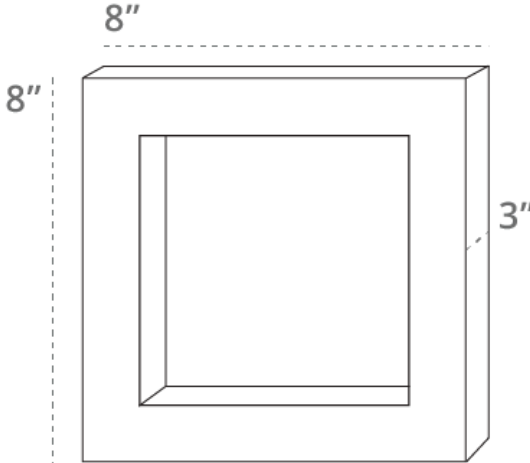
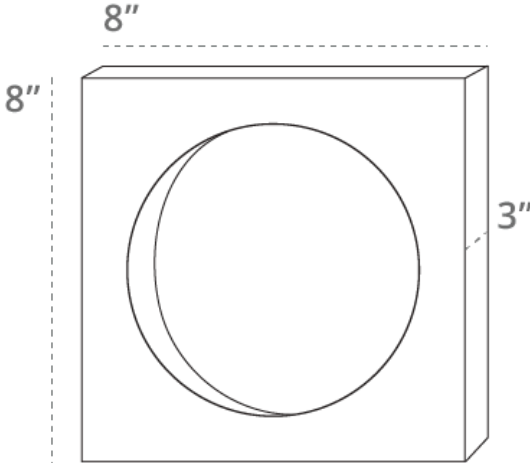

Standard thickness for Belgian Reproduction Privé is 3".
Please note all dimensions are nominal and can vary +/- 1/8".

BELGIAN REPRODUCTION: PRIVÉ

What's in our tile: Timeless breeze block reveals and conceals, exposes and protects, adding both detail and structure in more temperate conditions. Belgian Reproduction: Privé is our modern terracotta take on this enduring motif, with geometric forms that elevate almost any aesthetic.

There will be some degree of variation in color, shade, size and texture across production lots or batches. This means that your sample may not be a perfect match with your actual order, and that your add-on order may not be a perfect match to either. **This is the beauty of artisanal tile!**

INSPECTING YOUR SHIPMENT

- **WHAT TO EXPECT** – Breeze blocks are blocks of terra cotta featuring bold geometric patterns. ALSO - Dust and shipping residue are to be expected and should be cleaned prior to installing.
- **BLEND BLEND BLEND** – Pieces from this collection will display variations in shade and color. It is important to blend them once they arrive and place them in their installation area to ensure you have the layout you want before installing.
- **ORDER EXTRA!** - Industry standard suggests adding at least 20% overage due to potential shipping breakage, or future repairs.
- **SHIPMENTS ARE SUBJECT TO WEATHER** – Items may be exposed to moisture and/or condensation during production or shipping which may affect the color of the tiles once received. Setting the tiles out to dry prior to installation will return the color to normal. Do not install them until fully dried.

INSTALLATION FYIs

- **GENERAL GUIDELINES, NOT INSTRUCTIONS** - OUTERclé offers general information about our pieces and their unique qualities and usages. Proper installation is crucial to the stability and enduring beauty of breeze blocks. No two installations are the same. For more complex installations (walls of greater height, installing in harsh climates, etc) we recommend consulting a structural engineer or architect to ensure your breeze block installation is suitable for your intended space and climate.

- **BREEZE BLOCK INSTALLATIONS HAVE UNIQUE CHALLENGES** - Freezing temperatures, foundational stability and durability, as well as interior/exterior support or lack thereof can affect the integrity of your breeze block installation. These factors, as well as others, must be taken into consideration before installation.
- **FOUNDATIONS** - Breeze blocks must be installed on a flat hard surface. Consult with your installer and/or structural engineer to determine your installation area's suitability.
- **BREEZE BLOCKS REQUIRE ADHESIVE** - You must use adhesive between breeze blocks. DO NOT dry stack them. If using a metal frame to support your breeze block wall, the blocks may be adhered to the frame using an adhesive suitable for adhering masonry to metal (i.e. liquid nails). Consult with your professional mason regarding the best adhesive for your project.
- **BREEZE BLOCKS REQUIRE SUPPORT** - BREEZE BLOCK WALLS ARE NOT INTENDED TO BE LOAD BEARING. Reinforcing your breeze block installation is crucial to its success and longevity.
 - Ideally, installations should have many points of structural integrity to adhere your breeze blocks to (interior reinforcement (rebar), existing walls, etc).
 - Metal and wooden framing are popular options for supporting breeze block walls.
 - Breeze blocks can be inserted into a wall for seamless structural support between blocks.
- **REQUIRE YOUR INSTALLER PERFORM A "DRY RUN" BEFORE BEGINNING YOUR INSTALLATION** – Before installing, lay out all your breeze blocks. Your wall measurements should match your breeze block layout to avoid having to make cuts. Breeze blocks are not meant to be cut, doing so can affect the installation's structural integrity as well as disrupting your installation pattern. Also, be sure to account for grout joints when making measurements for your design.
- **INSTALLATION DEEMS ACCEPTANCE OF YOUR ORDER** - If you are not 100% sure of your breeze blocks - DO NOT INSTALL THEM. As is standard in the tile industry and with all construction materials, installation deems acceptance of materials. Do not install if there are visible issues. If you have any doubts or are unsure of what qualifies as a visible issue please reach out to us PRIOR to installation. Our tiles are subject to variations in color, texture, size, and finish. Misuse by contractor or end-user including but not limited to negligence, physical and/or chemical abuse, as well as order shortages ARE NOT an OUTERclé responsibility and therefore, not covered by OUTERclé's warranty.
- **BREEZE BLOCKS ARE A MATERIAL. INSTALLATION ERRORS ARE NOT THE FAULT OF THE MATERIAL** – Installation problems will arise from inexperienced installers, substrate, or construction engineering and/or installation issues. Please refer to your project architect, structural engineer and/or installer for best results.

- **PLEASE CONFIRM YOUR INSTALLER'S LEVEL OF EXPERIENCE** - We strongly suggest choosing installers who have shown their commitment to their craft and remained current with the latest methods and materials. We suggest requiring references and a portfolio along with a bid or estimate to ensure the installer has successfully completed work of similar size, scope, and complexity. Your installation will only be as good as your installer.
 - **DO NOT USE TAPE, BLUE TAPE, OR OTHER TAPE** - Do not use blue tape or other construction tape during product installation. We cannot guarantee that the tape will not erode or damage our products.
 - The above information is based on industry-standard recommendations. Local building codes should also be reviewed.
-

INSTALLATION AREAS

- Breeze blocks are not freeze/thaw resistant.
 - Breeze blocks should not be installed on a shifting substrate (sand, gravel, etc).
 - Breeze Blocks are UV resistant.
 - Breeze Blocks are heat resistant.
-

MORTAR & GROUT

- OUTERclé recommends a $\frac{3}{8}$ " grout joint with this collection.
- Breeze block walls can be built using either masonry cement or a cementitious sanded grout, as used in traditional tile installations. Consult with your structural engineer or mason on which adhesive works best for your project.

- Grout color selection is always up to our client and/or their design professional. However, OUTERclé is often asked for our opinion on best grout selections for our tiles. Due to the large array of grout colors that are now available, OUTERclé would like to offer this general guideline on a grout color selection for any of your OUTERclé tiles.
 - First, have your contractor complete your tile installation, except for the grout portion.
 - Next, ask your contractor to bring ALL grout color charts from his preferred grout manufacturer for your review.
 - Lastly, choose a time of day when you are most pleased with the lighting in your space (either natural lighting, installed lighting or a blend of both). During that lighting and time of day, select the grout color that best matches your tile selection.

 - If you are working with highly color-variegated blocks, we recommend that you follow the above recommendations—but match your grout to the color in your installation that you would like to accentuate.

 - If your contractor is having any issues or questions regarding mortar or grout, please reach out to the manufacturer. They are the best and fastest line of contact.
-

SEALING, MAINTENANCE, AND CARE

- Breeze blocks are porous and require sealing. When sealing, remember to avoid sealing the top, bottom and sides of the blocks.

- Please follow Laticrete's [Sealing, Maintenance, and Care Guide](#) for more guidance on cleaning, maintaining, and caring for your tile installation.

- **If you have any questions regarding Laticrete products or how to use them, please contact Laticrete directly by phone: 1-800-243-4788 X 1235.**

ADDITIONAL SPECIFICATIONS

AVERAGE COEFFICIENT OF FRICTION (DCOF ACUTEST)

DCOF testing is not performed on Breeze Blocks.

FREEZE/THAW RESISTANCE (ASTM C1026)

Breeze Blocks are not freeze/thaw resistant.

The Freeze/Thaw resistance test is a guide for choosing tiles suitable to environments where freezing and thawing can occur.

WATER ABSORPTION (ASTM C373)

Avg. 26.4%; non-vitreous.

The water absorption test determines how much a tile absorbs when immersed in water. A lower number generally means a tile is better suited for outdoor installations.

Please note that application of a sealant may decrease a tile's water absorption.

ACID RESISTANCE

Breeze Blocks are not resistant to acids and only mild, pH neutral cleaners should be used.

SOLAR REFLECTANCE INDEX (ASTM E1980)

Solar Reflectance Index: testing has not yet been completed

This test indicates how hot a tile is likely to become when solar radiation is present on the surface. The higher the score, the greater the tile's capacity to reflect and release heat from the sun.

LEED Credit for Heat Island Reduction requires the use of outdoor pavers achieving an overall SRI score of at least 29 for the entire project.

COLOR, TEXTURE AND SIZE VARIATION

Color variation: level 3 - medium

Texture variation: level 3 - medium

Size variation: level 3 - heavy

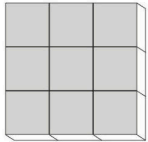
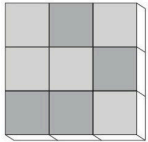
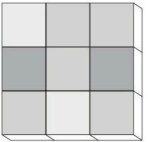
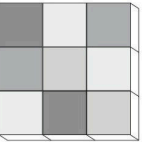
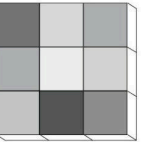
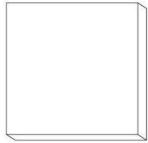
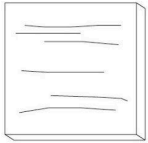
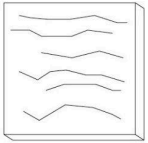
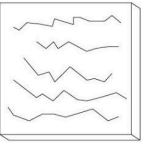
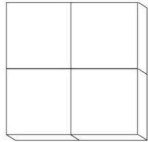
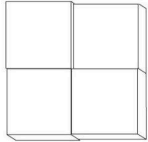
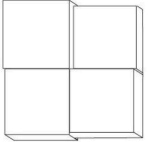
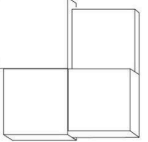
CATEGORY	LEVEL 1	LEVEL 2	LEVEL 3	LEVEL 4	LEVEL 5
COLOR VARIATION	 low	 slight	 medium	 heavy	 extreme
TEXTURE VARIATION	 smooth	 slight	 medium	 heavy	n/a
SIZE VARIATION	 slight	 medium	 heavy	 extreme	n/a

IMPERFECTIONS

Pits/Chips: level 1 - will occur

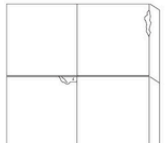
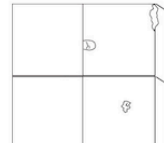
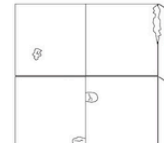
CATEGORY	LEVEL 1	LEVEL 2	LEVEL 3
PITS / CHIPS	 will occur	 prevalent	 heavy

Cracks: level 1 - will occur

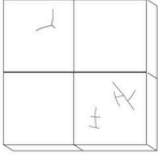
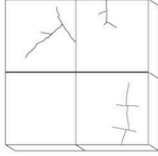
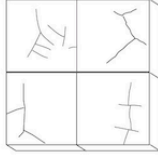
CATEGORY	LEVEL 1	LEVEL 2	LEVEL 3
CRACKS / CRAZING	 <p>will occur</p>	 <p>prevalent</p>	 <p>heavy</p>

PRODUCT DESCRIPTION

Hand-formed and fired, unglazed, terracotta blocks.

PRODUCT COMPONENTS

Clay

DIMENSIONS

Colonnade	20.3 cm x 20.3 cm x 7.6 cm (8" x 8" x 3") / 2.27 kg per tile (5 lb), Inner circle: 15.2 cm (6")
Courtyard Cube	20.3 cm x 20.3 cm x 7.6 cm (8" x 8" x 3") / 1.81 kg per tile (4 lb), Inner square: 15.2 cm x 15.2 cm (6" x 6")

* Please note all dimensions are nominal and can vary +/- 1/8".

LEED CREDITS

The product is an inherently non-emitting source of VOCs (stone, ceramic, metals, powder-coated metals, plated or anodized metal, glass, cement, clay brick, and unfinished or untreated solid wood) and has no integral organic -based surface coatings, binders, or sealants.

Breeze Blocks are considered 'inherently non-emitting sources' under the Low-emitting Materials Credit of LEEDv4/v4.1. This is currently the only credit for our Belgian Reproduction tile that is eligible to be used toward LEED.

'Inherently non-emitting' means that these tile types have been shown to not contribute emissions to indoor environments and are therefore exempt from demonstrating compliance with CDPH v1.1-2010 or CDPH v1.2-2017.

Use of these tiles as Wall or Flooring materials should be entered in the LEED v4.1 low-emitting materials Calculator and identified as 'inherently non-emitting' in the Products Tab (Column L).

Disclosures for MR Credit Material Ingredient Disclosures under LEEDv4/v4.1, are not available at this time. We are exploring our disclosure options and have not established a timeline for completion.

Disclosures for MR Credit Environmental Product Declarations under LEEDv4/v4.1, are not available at this time. We are exploring our disclosure options and have not established a timeline for completion.

Contribution to MR Credit Material Sourcing under LEEDv4/v4.1, does not apply as there is no recycled content, no bio-based materials, no wood, no reused products included in our tile at this time. Extended producer responsibility programs are highly difficult to manage given the nature of end-of-use tile removal methods. *Tile can last hundreds of years but fashions often change, which is the dominant reason for its removal. We work hard to ensure our stone tiles can withstand the test of time while remaining timeless.*

RECYCLED CONTENT

There is currently no recycled content in breeze blocks. See material sourcing disclosure above.

PERCENTAGE OF PRE-CONSUMER AND/OR POST-CONSUMER MATERIALS

There is currently no pre-consumer or post-consumer material content in breeze blocks. See Material Sourcing disclosure above.

FIRE RATING

Typically, ceramic tile does not need to have fire rating testing performed. It is our understanding from TCNA that the explanation that ceramic is inorganic, inert, and typically free of materials that could burn or produce smoke is generally enough to satisfy a specifier and that testing is not necessary. Also, the temperatures observed in the testing are typically lower than the temperatures at which ceramic tiles are fired.

Terracotta is a ceramic tile and falls under the description, “because ceramic tile is non-flammable and does not produce smoke in a fire, it inherently meets the flame spread and smoke development requirements of Section 803 of the International Building Code (IBC) for interior wall and ceiling materials.”