

Product Installation Manual

JA-1E

FOR:

JA1010、 JA3320、

JA3400、 JA3500、

JA3510

Product Installation Manual

Installation Instruction for Bidet

Before Installing

FOR:
JA1010、JA3320、
JA3400、JA3500、
JA3510

1. Realize all the stipulates for pipelines preposition for water supply and drain.
2. Make sure the wall should be straight.
3. Read the instruction carefully to be familiar with the tools, fittings and installation procedures to prevent any unnecessary damage.
4. Check the fittings follow the fitting form and check whether there is any damage of the product.
5. Because the ceramics is easy to be damaged, please handle it gently and the nut should not be overtightened.
6. Make sure water supply has been turned off..

NOTE: 1. Refer to the newest information of the printed matter. We reserve the rights to change the features, packing and fittings of the products without notice.
2. Please keep the installation instruction carefully (including installation procedure, fitting form, trouble shooting and notice.)

Tools and Fittings (Not supplied with the product)

- | | | |
|-----------------------|----------------------|------------------------|
| 1.monkey wrench | 5.level | 9.connecting soft pipe |
| 2.pipe wrench | 6.hacksaw | 10.silicone |
| 3.tapeline | 7.sinker | |
| 4.percussive drilling | 8.water supply valve | |

Installation Procedure

1. Put the bidet onto the suitable position, and make the water outlet of bidet aligned with the drainage outlet .
Note: Preposition enough distance for connecting water supply pipe and drain pipe.
2. Mark the installing holes on the floor.
3. Remove the bidet carefully and drill holes according to the mark. Insert the expansible plastics or install 7# fixing plastic.
4. Install faucet, water supply valve and drain units according to the installation instruction for fittings.
5. Put the bidet onto the suitable position, and get the water supply valve and the faucet connected with soft pipe. Then adjust the connecting bar.
6. Get the screw aligned with the plastic particle and fix the bidet onto the floor. Then cover the decoration cap.
7. Daub a layer of silicone between the bidet and the floor.

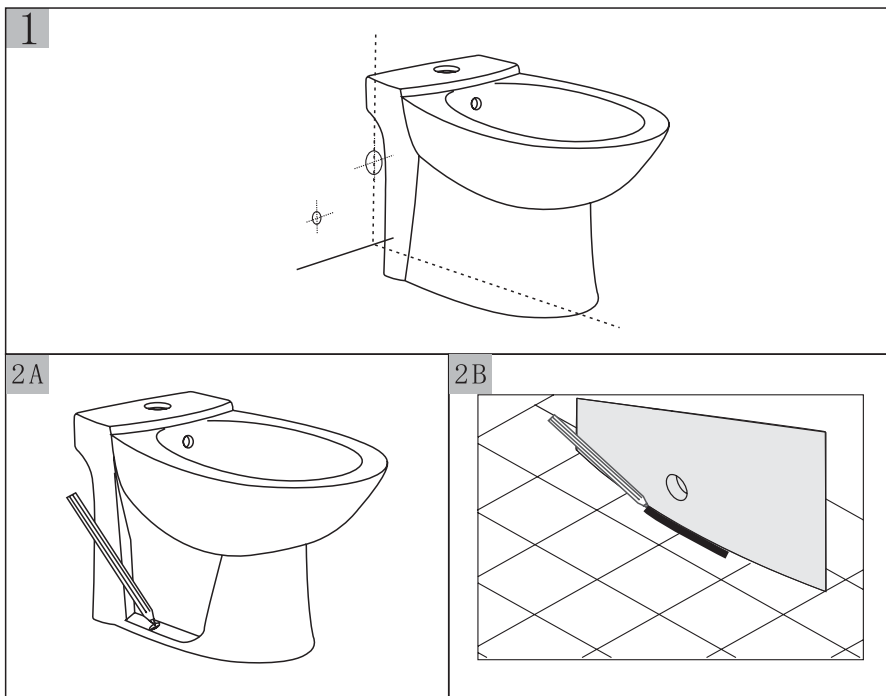

3A

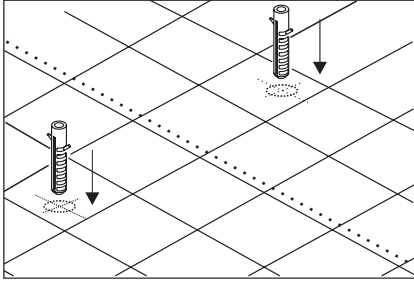

3B

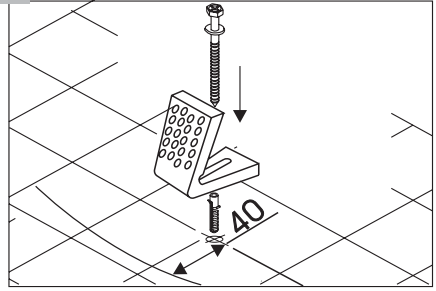

4

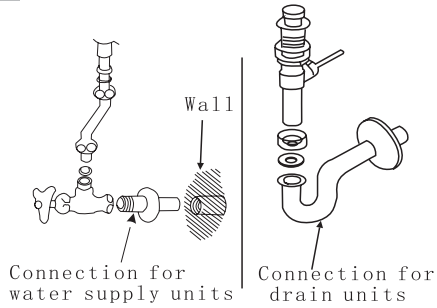

5

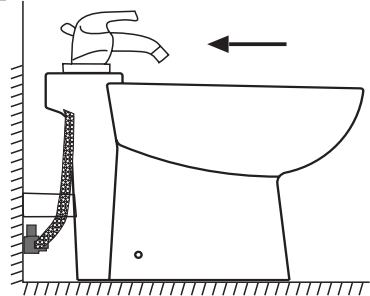

6A

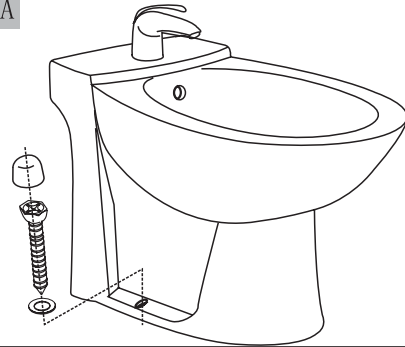

6B

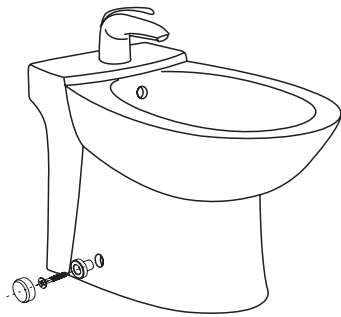

7

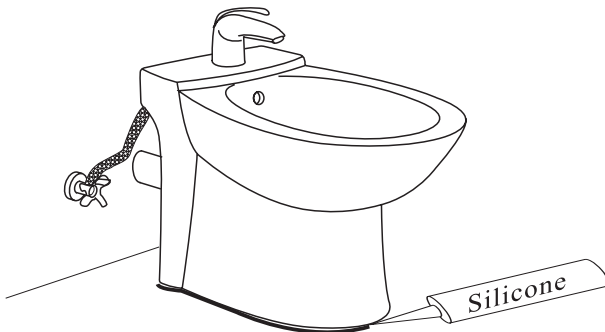

Troubleshooting

Malfunctions	Causes	Solutions
No water remained in the basin	1. Waste and water outlet have not been sealed. 2. gasket of adjusting valve for waste is broken.	1. Readjust and get them sealed. 2. Change the gasket.
Slow drainage	1. The angle of connecting bar is not enough 2. Water outlet has been plugged.	1. Readjust the angle 2. Clean the water outlet
The basin is overflow or smell	The drainage pipe has been plugged.	Check and clean the pipe

NOTE:

1. Do not use the bidet when the water temperature is 0°C below, please stop using it when the temperature is under 0 degree centigrade, and clean away the surplus water in it, otherwise the product will be damaged when the water icing and expanded.

2. Please keep the product cleaning if it is used in hard water area.
Cleaning suggestion: once a week.

3. Do not use corrosive chemicals to clean the product to prevent any damage of glaze.

