

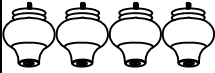
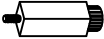
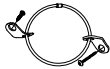

Thank you for purchasing this quality product. Be sure to check all packing materials carefully for small parts which may have come loose inside the carton during shipment. Identify and count all items and compare with the parts list and hardware list shown below.

PARTS LIST			
NO	DESCRIPTION	SKETCH	QTY
A	Dresser		1pc
B	Bun Foot		4pcs
C	Center Support Leg		1pc

HARDWARE LIST			
NO	DESCRIPTION	SKETCH	QTY
1	Anti-Tipping Kit		1set

PLACE WOOD PARTS ON A
CLEAN NON-ABRASIVE SURFACE

Step 1: Locate the Bun Foot (B) and Center Support Leg (C) inside boxes at the bottom drawer of the Dresser (A).

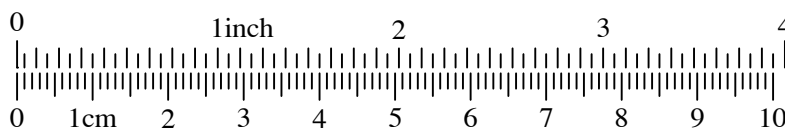
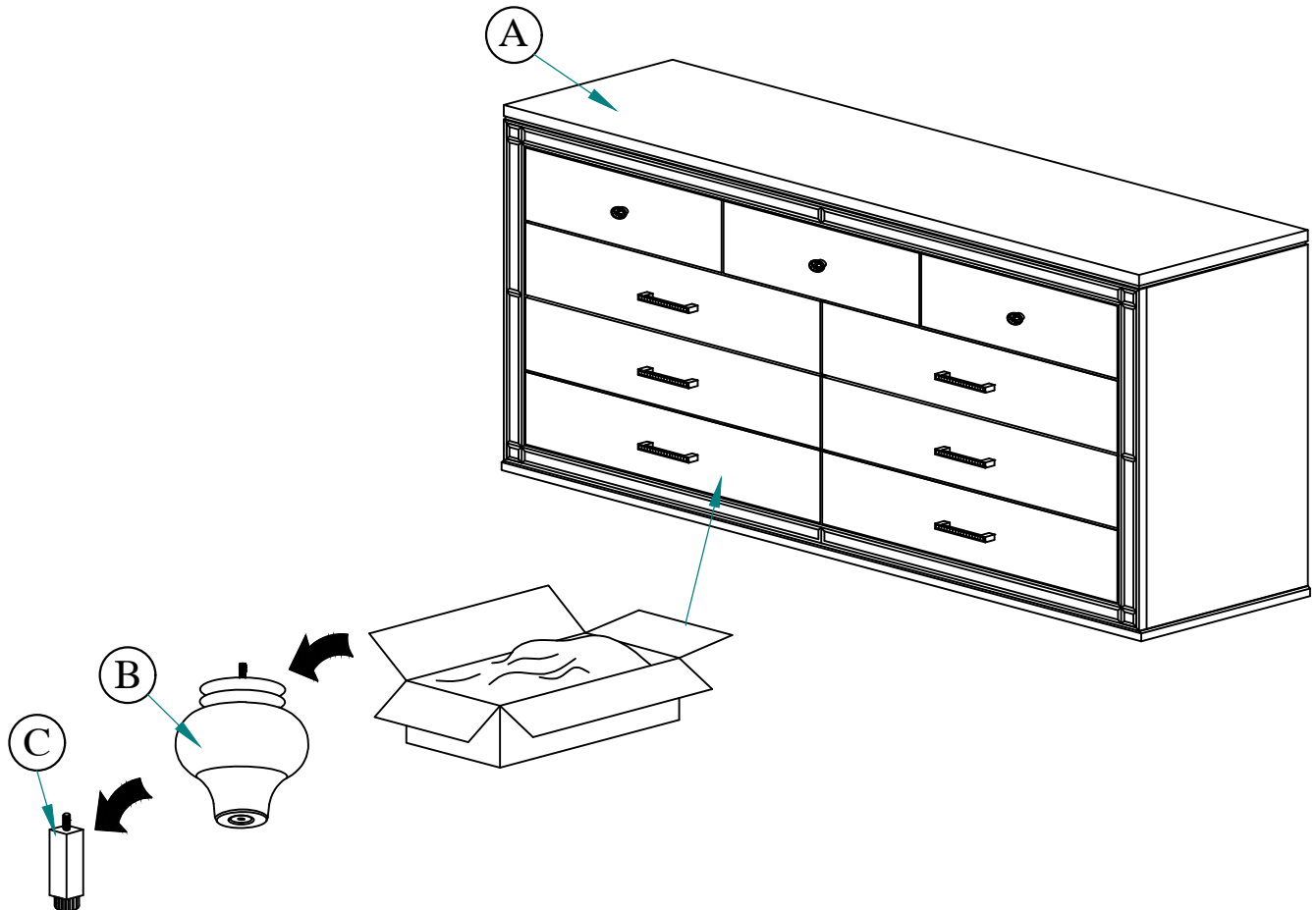



PLACE WOOD PARTS ON A
CLEAN NON-ABRASIVE SURFACE

Step 2: Assemble the Bun Foot (B) to the Dresser (A).

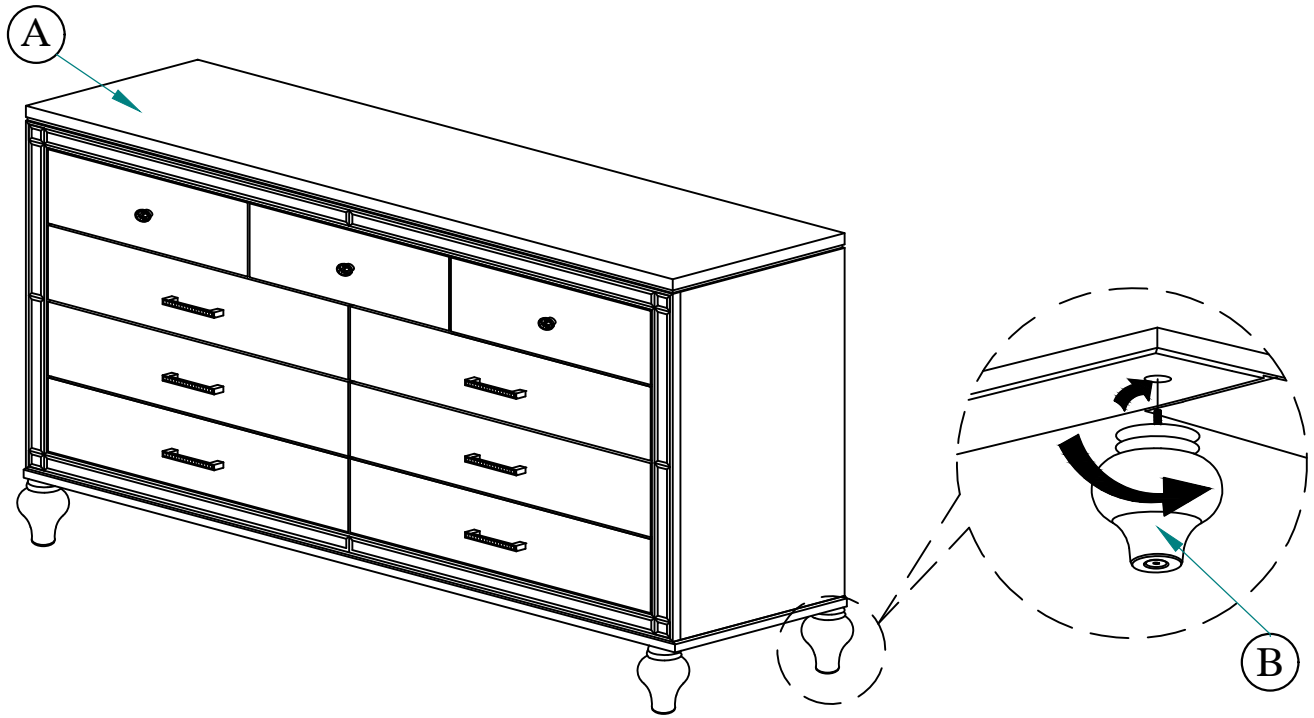

Step 3: Assemble the Center Support Leg (C) to the Dresser (A). Adjust the leveler on the Center Support Leg (C) with the floor.

PLACE WOOD PARTS ON A
CLEAN NON-ABRASIVE SURFACE

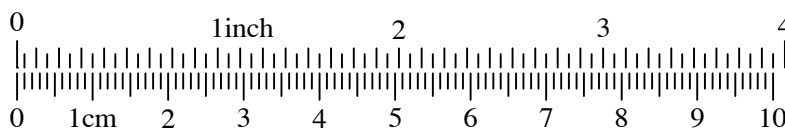
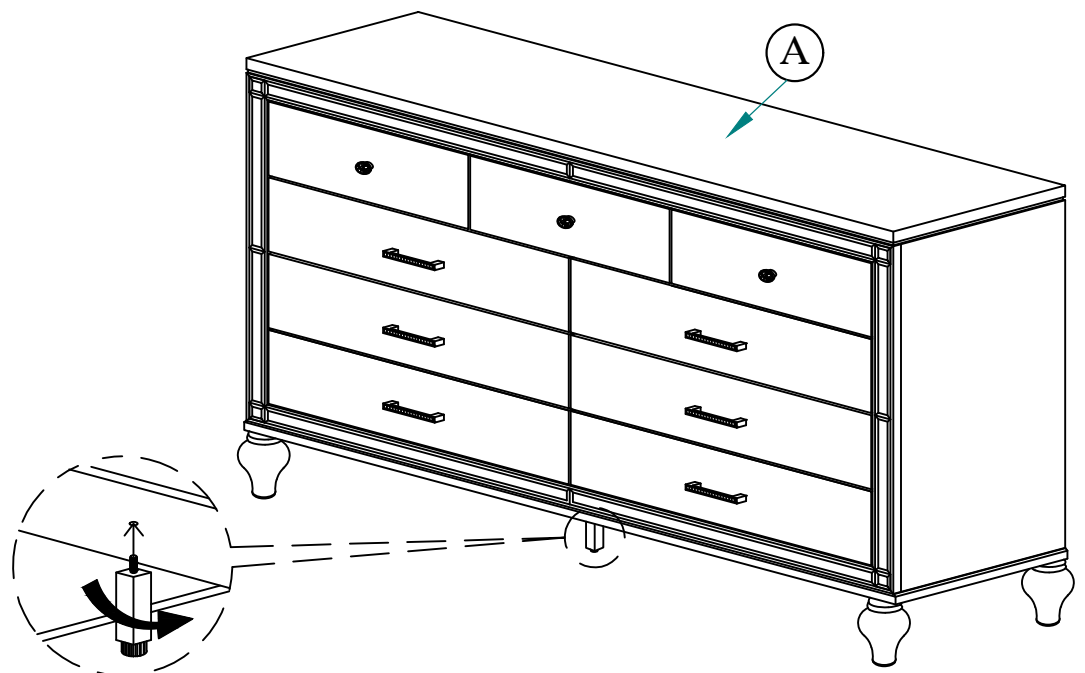



PLACE WOOD PARTS ON A
CLEAN NON-ABRASIVE SURFACE

Step 4: Install the Anti-Tipping Kit. Anti-Tipping Kit must always be used to prevent the furniture from tipping.

