

FLEXSTEEL®

Flexsteel Power Sectional with Power Headrests and Lumbars

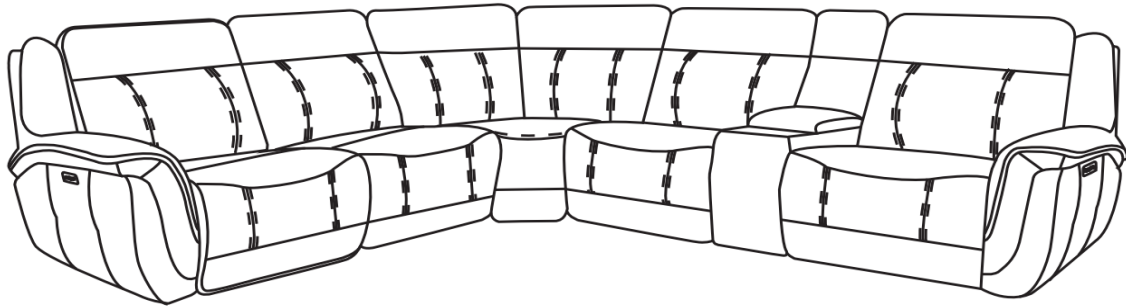











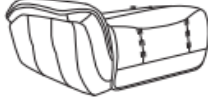

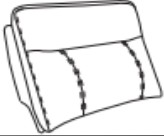
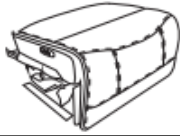
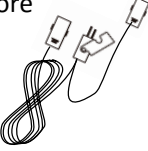
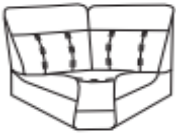
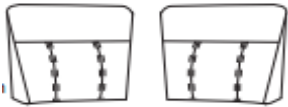

IMPORTANT NOTE

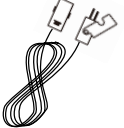
Read these instructions carefully, and familiarize yourself with each procedure before assembling the furniture. Check that you have all the component parts, and familiarize yourself with each part before proceeding.

Take all the fittings out of the plastic bags and separate them into groups. Ensure you have enough space to lay out all the parts before assembly. To prevent damage to the parts, we recommend that you assemble the units on a soft, level surface.

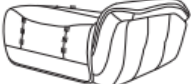
LIST OF PARTS

Item.	Description	Model	Parts		
A	LSF Dual power recliner with Lumbar		A1. Back Cushion 1 piece 	A2. Seat Cushion 1 piece 	A3. Wall Plug Transformer 1 piece 
B	Dual Power armless recliner with Lumbar		B1. Back Cushion 1 piece 	B2. Seat Cushion 1 piece 	B3. Y split core 1 piece 
C	Wedge		C1. Back Cushion 2 pieces 	C2. Seat Cushion 1 piece 	
D	Armless chair		D1. Back Cushion 1 piece 	D2. Seat Cushion 1 piece 	D3. Extension cord 1 piece 
E	Straight console				
F	RSF Dual power recliner with Lumbar		F1. Back Cushion 1 piece 	F2. Seat Cushion 1 piece 	F3. Wall Plug Transformer 1 piece 

Assembly Instructions 2/4

STEP 1: Detach the wall plug transformers from the bottom of the Seat of LSF/RSF recliners (A2, F2). (Figure 1.)

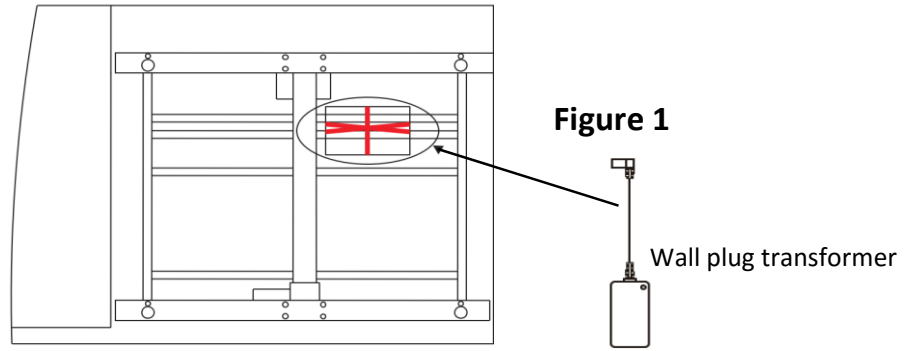

STEP 2: Release Power cores from the middle bottom rears of the LSF/RSF/armless recliners/console (A2, F2, B2, E), from the KD connector of the armless chair. (Figure 2.)

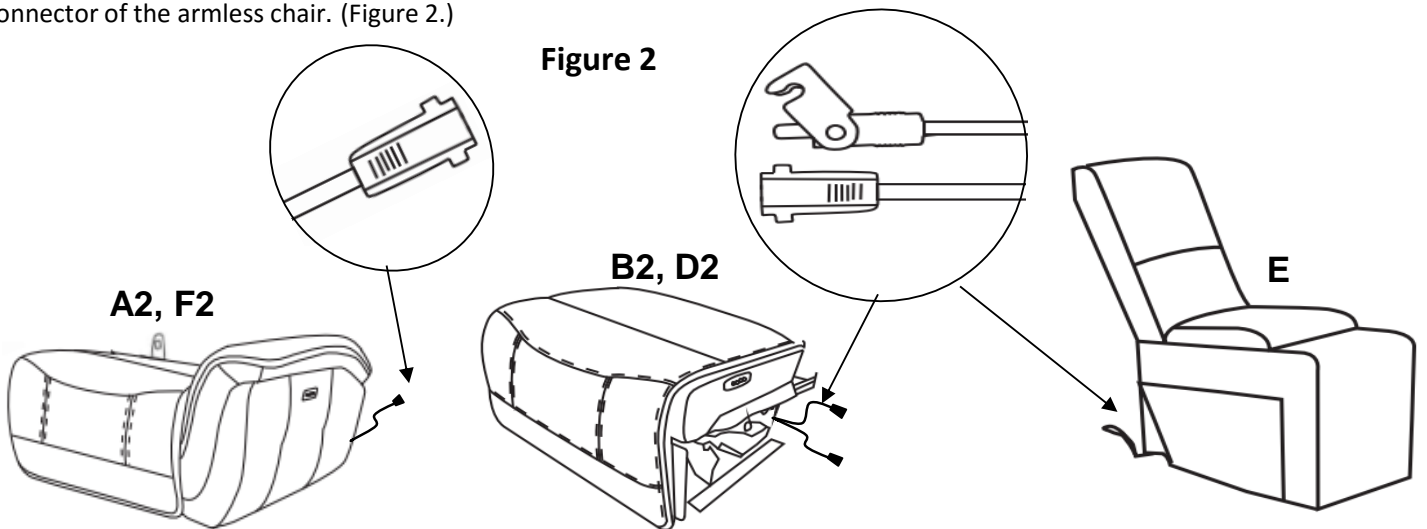

STEP 3: Attach the Back to the Seat. Ensure the latches fit well. (See Figure 3.)

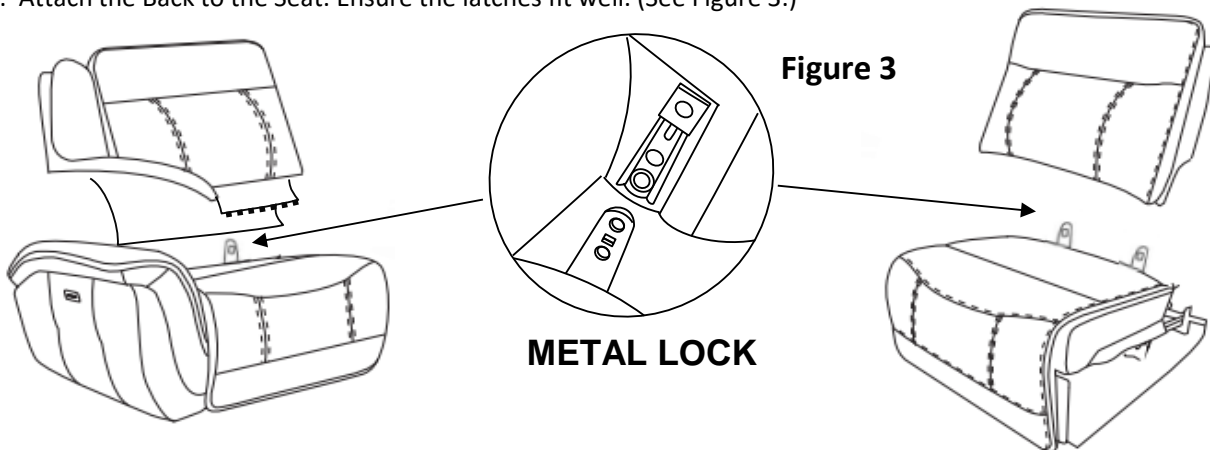

STEP 4: Zip the front flap of the Back to the Seat of LAF/RAF recliners. (See Figure 4.)

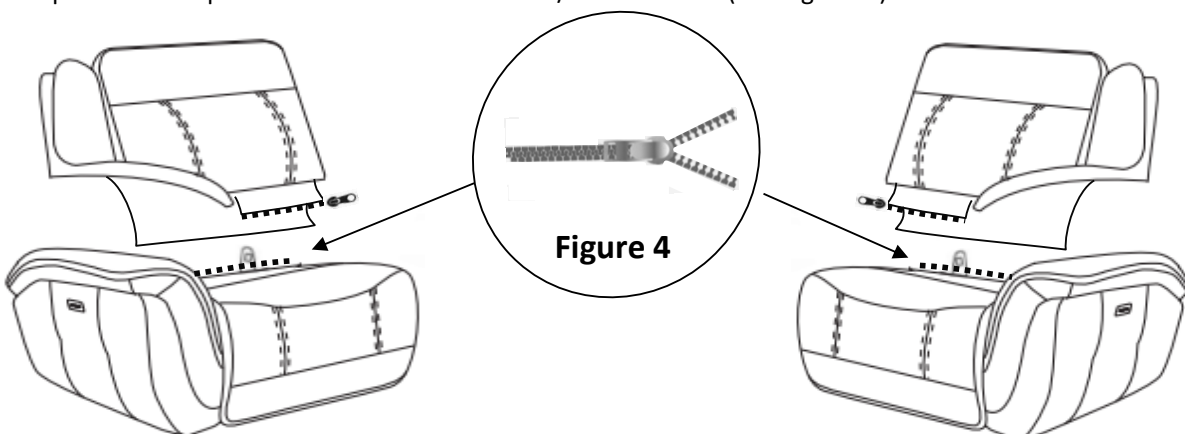

Assembly Instructions 3/4

STEP 5: Position your product in the area of its intended use and connect together using the sectional connectors. (See Figure 5.)

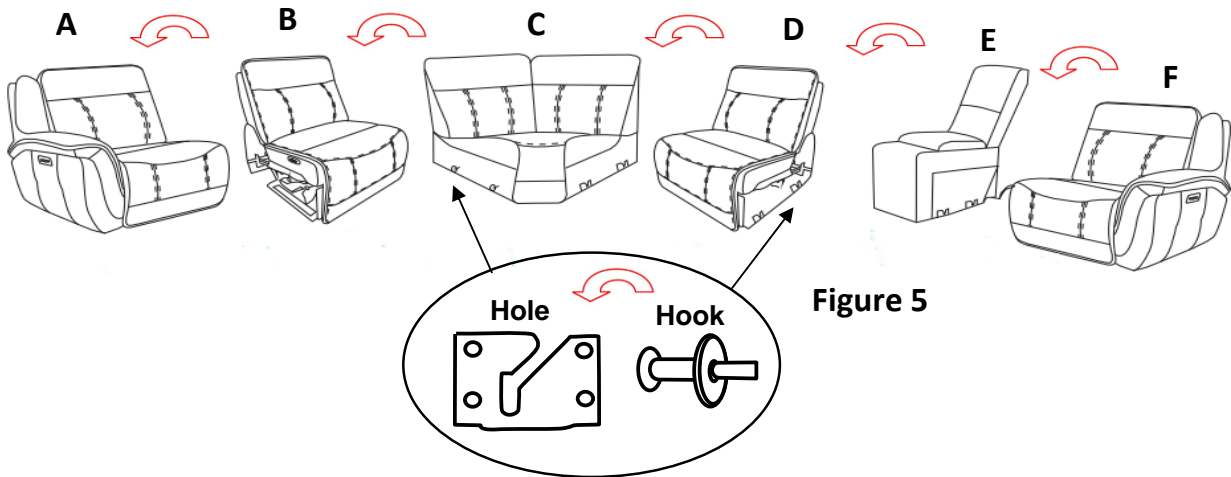

STEP 6: Flip up the back flaps, Plug the headrest/ lumbar connectors (if applicable) at the middle bottom from the Backs (A1, B1, F1). Make sure to close the clip lock to prevent the connection from coming loose. (See the Figure 6.)

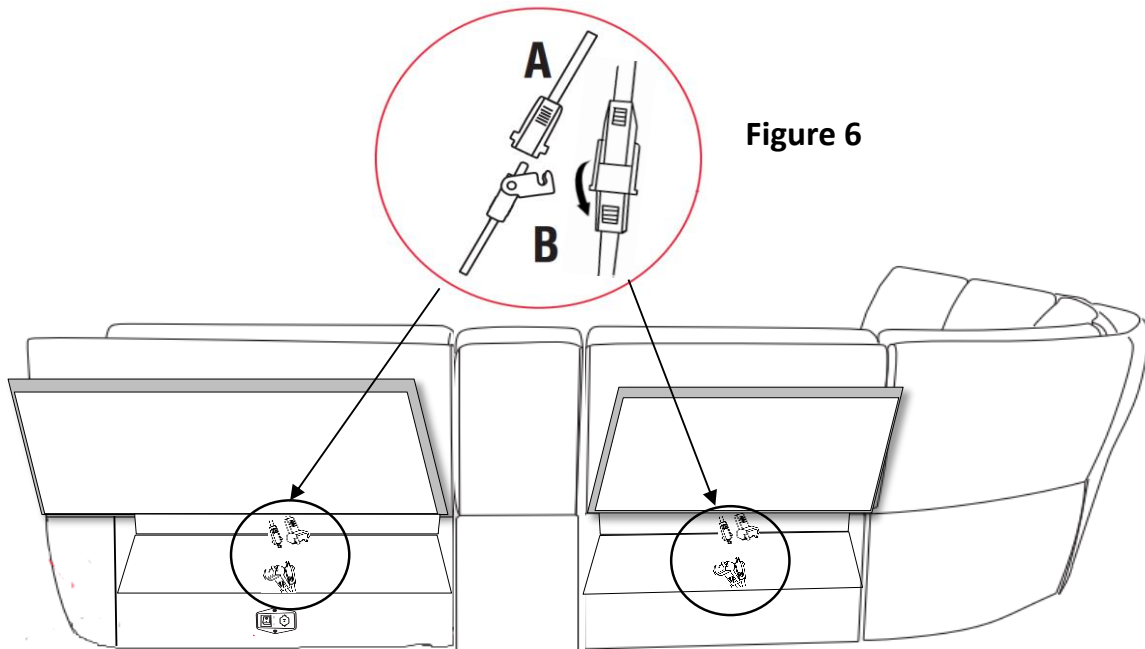

STEP 7: Connect the power cords of all power recliners (released in **Step 2**) to each others. Make sure to close the clip lock to prevent the connection from coming loose. Extra cores are used when change the order of furniture. (See the Figure 7.)

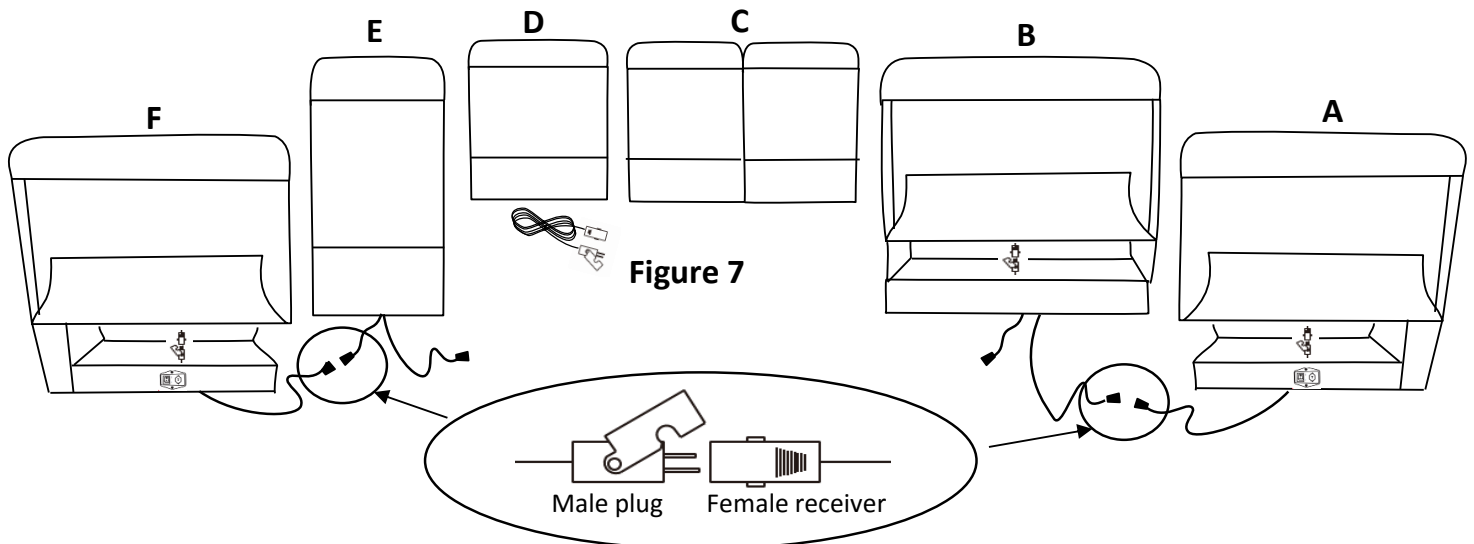

Assembly Instructions 4/4

STEP 8: Attach the power transformer cord to the matching Plug found at the bottom rear of the power recliners (A, F) as seen below. Ensure the transformer power switch is switched to the " ON " position. (See the Figure 8.)

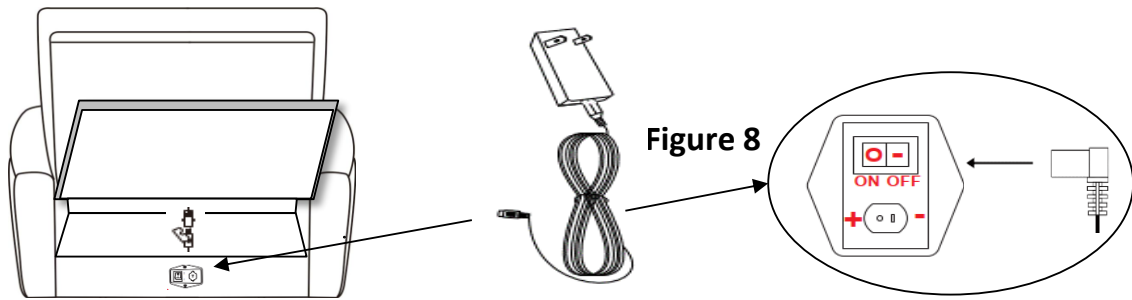

STEP 9: Fasten the back flap to the bottom of the furniture to complete assembly. (See the Figure 9.)

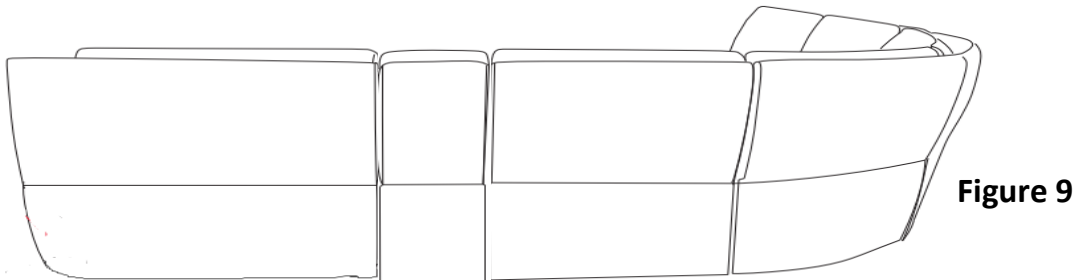

STEP 10: Connect wall plug transformers into a nearby outlet, still making sure it is clear of the metal base. (See the Figure 10.)

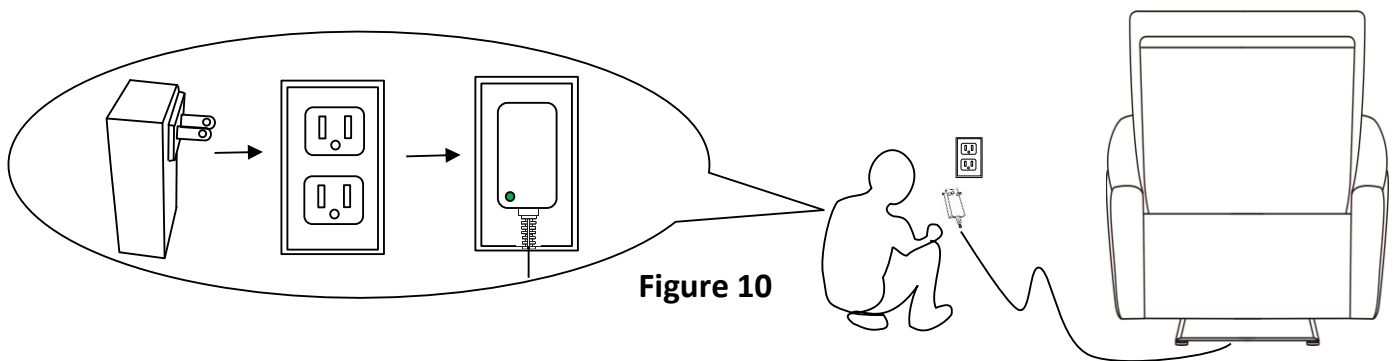

Disassembly Instructions

To remove the back from the base, use a screwdriver pressing outward on the black tab in the metal receivers on both sides of the chair back and lift the back from the base of the chair to release.

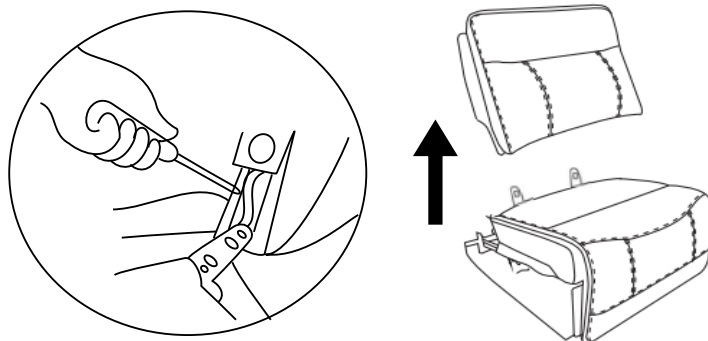

CARE INSTRUCTION

- To avoid any risk of suffocation to children or pets, dispose of all plastic bags immediately.
- To ensure proper performance, occasionally check for loose screws and tighten as needed.
- If the reclining functions are not working properly, check for loose cable connections before contacting the retailer.