

Large Kinetic Windmill Garden Stake

Assembly Instructions

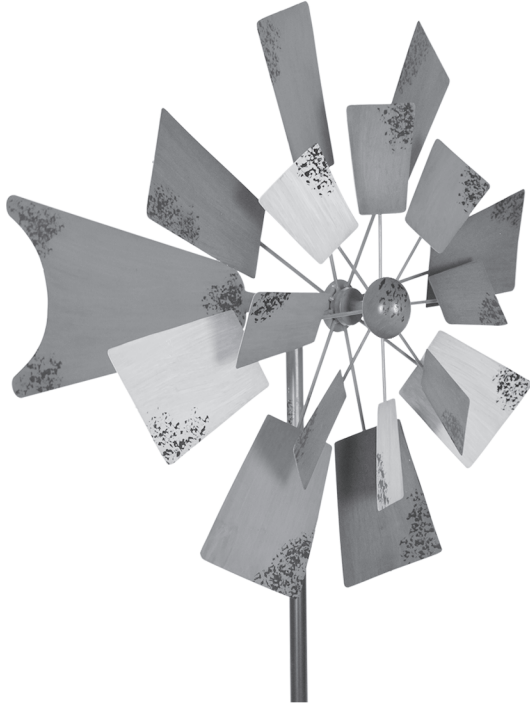

Parts List

- A. Barrel
- B. Nut
- C. Fin
- D. Small Wheel
- E. Top Pole
- F. Middle Pole
- G. Stake Support
- H. Stake Base
- I. Large Wheel

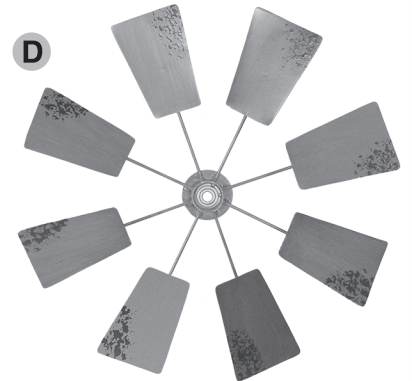
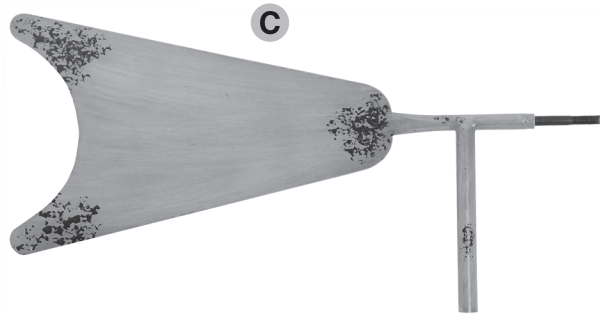
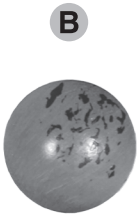
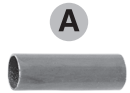

H

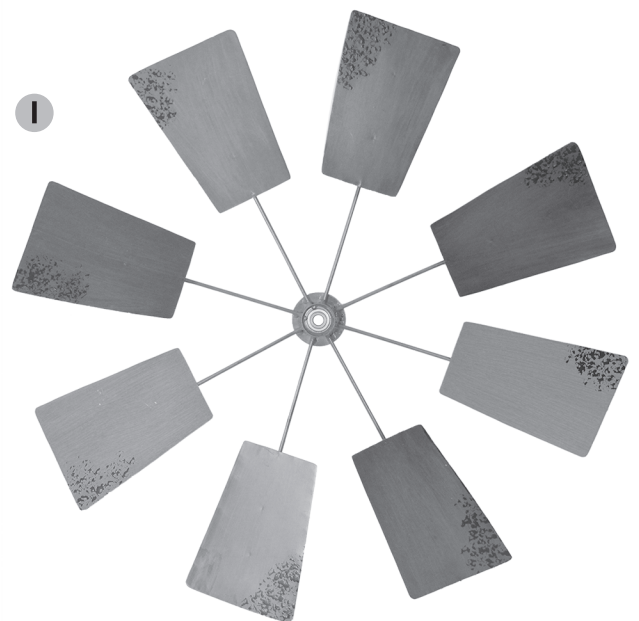

1. Attach large wheel (I) facing outward into fin (C) by inserting through the hole. Next, slide on barrel (A) into fin (C) and attach small wheel (D). Finally, attach nut (B) by turning to the right until firmly tightened.

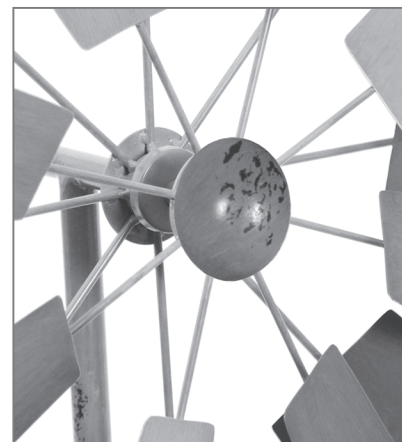
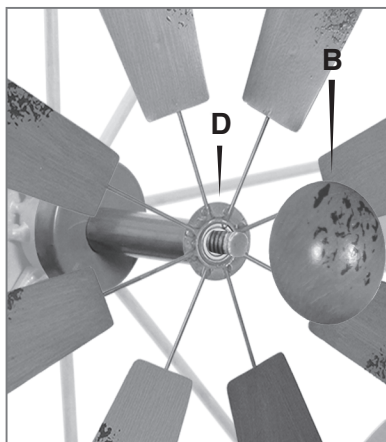
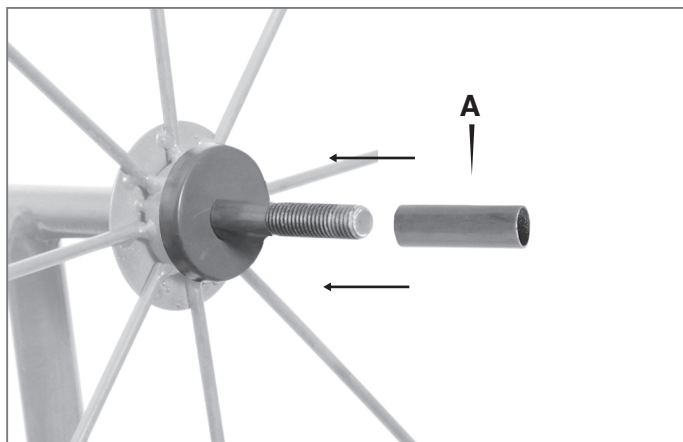

Lay assembly on the ground for the following steps.

2. Attach top pole (E) to fin (C) by inserting the top pole directly into the bottom of the fin. Then, attach middle pole (F) into the bottom of the top pole (E) by turning to the right until firmly tightened. Next, slide in stake support (G) over the stake base (H). Finish assembly by slipping in the stake base (H) to the open end of that last pole attached until bottom locks. When everything is assembled, insert into ground and make

