

BV9356I

FULL iPod® / iPhone® CONTROL
DOUBLE-DIN DVD/MP3/CD
AM/FM RECEIVER FEATURING
6.2" (157mm) WIDESCREEN
TOUCHSCREEN TFT DIGITAL MONITOR
WITH USB AND SD MEMORY CARD
PORT AND FRONT PANEL AUX INPUT



BV9356I

FULL iPod® CONTROL
DOUBLE-DIN DVD/MP3/CD AM/FM RECEIVER
FEATURING 6.2" (157mm) WIDESCREEN
TOUCHSCREEN TFT DIGITAL MONITOR
WITH USB AND SD MEMORY CARD PORT AND
FRONT PANEL AUX INPUT

0613



iPod® is a trademark of Apple, Inc.
registered in the U.S. and other countries.

tech support: www.bossaudio.com/support

BOSS®

AUDIO SYSTEMS

BOSS Audio Systems
3451 Lunar Court • Oxnard, CA 93030

www.bossaudio.com

800.999.1236

BOSS®

AUDIO SYSTEMS

Boss Audio Systems is not affiliated with Apple, Inc.

17
18
19
20
21
22
23
24
25
26

INSTRUCTIONS

CONTENTS

| | |
|-------------------------------------|----|
| Panel Introduction..... | 02 |
| Basic Function | 03 |
| Remote Control Operation..... | 04 |
| Turn on/off | 06 |
| Access main interface | 06 |
| USB/SD Card Operation..... | 06 |
| Radio Operation..... | 07 |
| Disc Operation..... | 08 |
| Play/Eject Disc | 08 |
| DVD/VCD Disc Playback..... | 08 |
| CD Disc Playback..... | 08 |
| MP3/WMA Format Disc Playback..... | 08 |
| Touch Menu | 08 |
| ST. Wheel setting..... | 09 |
| Media Operation..... | 10 |
| External input operation | 10 |
| Other Operation..... | 11 |
| Rear view function | 11 |
| Access setup interface..... | 12 |
| General setting | 12 |
| Time setting | 12 |
| Language setting | 12 |
| Audio setting | 13 |
| Video setting | 13 |
| Radio setting | 13 |
| Touch calibration | 13 |
| Wiring Diagram | 15 |
| Trouble shooting..... | 15 |
| Specifications | 16 |
| Accessory | 17 |
| DVD Parental control function | 17 |

Warning: To ensure safety while driving and to comply with laws, drivers should not watch video or operate the video device while driving.

ACCESSORY

| Accessory | Quantity |
|-------------------|----------|
| Wire | 1PC |
| USB Cable | 1PC |
| Remote Controller | 1PC |
| Warranty card | 2PCS |
| Disassemble Key | 2PCS |

DVD Parental control function

DVD Parental control function

★ DVD Parental control function: The default set for DVD is #8 adult, which means all grades of DVD can be read without entering password. To change the default grade, you need to follow the below procedure: Press SETUP button on the remote, display will show the system set up menu and the submenu, select password and enter 0000, you will be able to choose the DVD grade as default.

PANEL INTRODUCTION

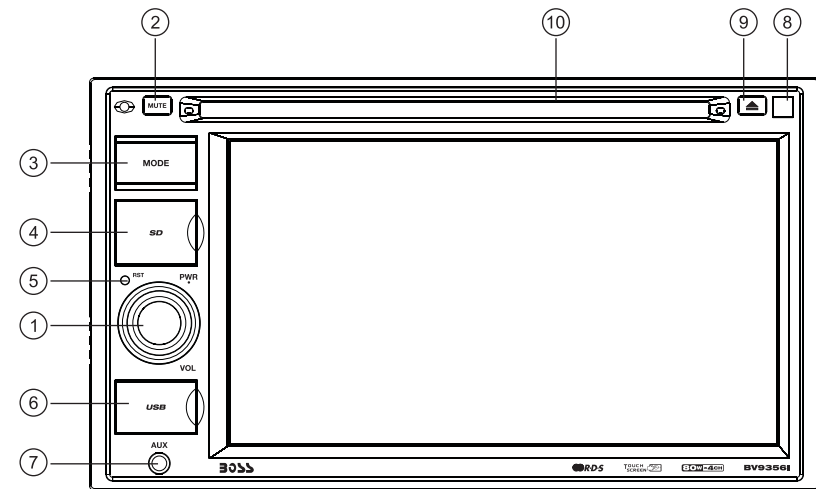

1. PWR/VOL button
2. MUTE button
3. MODE button
4. SD slot
5. RST
6. USB slot
7. AUX slot
8. IR
9. ▲
10. Disk load slot

1. PWR/VOL button

Press this button will turn on power, during working longer press this button will turn off power, on any mode, shortly press will return main menu, rotate this button will adjust volume level.

2. MUTE button

Press this button to shut off sound output, repress this button to resume sound output; Press this button longer to turn on/off TFT LCD display.

3. MODE button

When the unit is power on, Repeat press this button can switch to different function mode as following picture.

Note: When the device without connecting to USB、SD or DVD no disc inside, the system will automatically skip these related working mode.

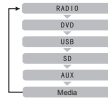

4. SD slot

Insert SD card, the unit will play the files automatically.

5. RST

Press this button and this unit will be restored to the initial state.

6. Dual (front and rear) USB

Insert USB removable device so as to read audio/video files.

▲ Warning: You can only use either front or rear USB at a time. Never connect both front and rear USB at the same time! This could cause malfunctions.

7. Dual (front and rear) AUX

To input external audio.

▲ Warning: You can only use either front or rear AUX at a time. Never connect both front and rear AUX at the same time.

8. IR

To receive infrared signal from the remote control.

9. ▲

Press this button can eject the disc.

10. Disk load slot

Opening for disks to enter or retreat.

SPECIFICATIONS

| | |
|-------------------------|---------------------|
| Power supply | DC 12V |
| Power range | 10.8-16.0V DC |
| Max Current Consumption | 15A |
| Ground system | Negative ground |
| Power Output | 80 WattsX4 Channels |

FM tuner

| | |
|--------------------------|---------------|
| US frequency range | 87.5-107.9MHz |
| European frequency range | 87.5-108MHz |
| Signal / Noise ratio | 55dB |
| Stereo separation | 30dB |
| Search station volt | 20-30dBuv |

AM tuner

| | |
|--------------------------|-------------|
| US frequency range | 530-1710KHz |
| European frequency range | 522-1620KHz |
| Limit noise sensitivity | 32dB |

DVD player

| | |
|--------------------|------------|
| S / N Ratio | 70dB |
| Frequency response | 20Hz-20KHz |

This unit is with switchable frequency.

You can switch from USA frequency to Europe frequency by following the below steps:
Step1. In main menu, press setup icon to enter the setup interface.

Step2. Press the Radio icon, and insert password 123456, then press "OK", the menu from which you can select the radio frequency will show.

Step3. Press "Radio region" and select the desired frequency by pressing the "up" and "down" arrow, then press it and setting is finished.

WIRING DIAGRAM

This player is equipped with ISO standard connector, please follow below instruction:

- Red - ACC ON (+12V)
- Yellow – 12 V Constant
- Black – Ground wire
- Blue - Power Antenna / Remote Amp Turn On
- Orange – Back-Up Camera Trigger (+)
- Grey/Grey black - Right front speaker (+/-)
- White/White black - Left front speaker (+/-)
- Purple/Purple black - Right rear speaker (+/-)
- Green/Green black - Left rear speaker (+/-)
- Parking Brake (-)

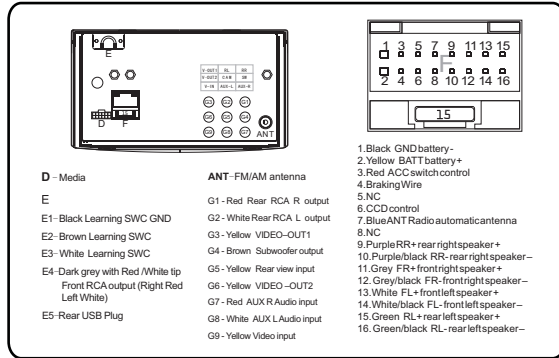

TROUBLE SHOOTING

| PROBLEM | CAUSE | SOLUTION |
|---|--|--|
| Cannot power on | Check fuse | Change fuse same as the old one |
| | Some factors cause MPU wrong operation | Press RES button on the panel by penpoint, then, power on |
| After ignition switch off, setting information all lose | Change battery or fuse | Reset information and save |
| Poor performance of radio station | Weak signal | Move the car to another place, then research |
| Cannot load disk | There is a disk inside | Remove disc before inserting another one |
| Cannot play disc | Disc is scratched | Change new disc |
| | Put wrong side of disc into the unit | Insert in the disk with sign side up |
| | Lens is dirty | Clean lens by lens clean disc |
| Cannot switch language/subtitle | There is only one language/subtitle in disc | If disc is not with multi-language/subtitle, it cannot switch language/subtitle |
| No image | Other factors cause MPU wrong operation | Press [RES] button on the panel by penpoint, then, power on |
| Cannot watch image during driving | It's not allowed to watch image during driving | Park the car in a safe place, put the car stall in " P " position, pull up the hand brake, parking brake wire must be grounded |

Remote Control Operation

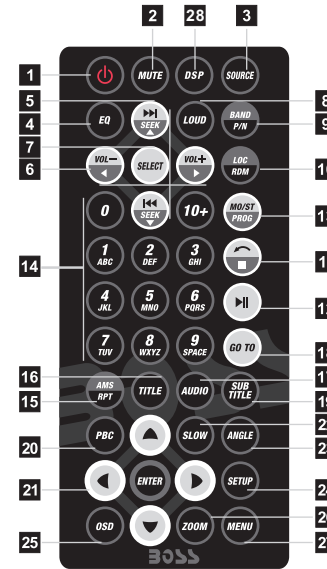

- | | | | |
|----|---------------|----|-------------------------|
| 1 | POWER ON/OFF | 15 | AMS / RPT |
| 2 | MUTE | 16 | TITLE |
| 3 | SOURCE | 17 | AUDIO |
| 4 | EQ | 18 | GO TO |
| 5 | SEEK+ / SEEK- | 19 | SUBTITLE |
| 6 | VOL+ / VOL- | 20 | PBC |
| 7 | SEL | 21 | UP / DOWN / L / R ENTER |
| 8 | LOUD | 22 | SLOW |
| 9 | BAND / P / N | 23 | ANGLE |
| 10 | LOC / RDM | 24 | SETUP |
| 11 | STOP | 25 | OSD |
| 12 | PLAY / PAUSE | 26 | ZOOM |
| 13 | ST / PROG | 27 | MENU |
| 14 | 0-10+ | 28 | DSP |

1. POWER

Press once to switch on, press again to switch off.

2. MUTE Button

Press once to turn off audio output, press again to resume volume level.

3. SOURCE Button

Press this button to change mode.

4. EQ Button

Press this button to choose POP、ROCK、CLASSIC、EQ off.

5. SEEK+ (▶▶) / SEEK- (◀◀) Button

In normal playback MP3、USB、SD songs, Press this button to previous song or next song.

6. VOL+ (→) / VOL- (←)

Press this button to increase or decrease volume level.

7. SEL Button

Press this button to choose sound feature.

8. LOUD Button

Press this button to startup LOUD function.

9. BAND-P/N Button

In radio mode, press this button to choose band.

In VCD、DVD mode, press this button to choose PAL、AUTO or NTSC system.

10. LOC / RDM Button

In radio mode, press this button to switch between local and direction.

In VCD、CD mode, press this key to randomly play.

11. STOP Button

Press this button to stop playing.

12. PLAY / PAUSE Button

Press this button to switch between play and pause.

In stop mode, press this button to play.

13. ST / PROG Button

In radio mode, press this button to choose stereo or mono station.

In audio mode, it can help STOP button to programmed play.

INSTRUCTIONS

14. 0-10+ Button

Press this button to choose desired song, section, preset stations.

Decimal numbers, for example the 19th song, press 10+ and 9 button.

15. AMS / RPT Button

In radio mode, press this button to browse stored stations.

In audio mode, press this button to play repeatedly.

16. TITLE Button

In DVD mode, press this button to play back to the top menu of disc.

17. AUDIO Button

In DVD mode, press this button to switch language of dialogue.

In VCD mode, press this button to choose left track, right track and stereo.

18. GO TO Button

In DVD mode, press this button, you can define playing time.

19. SUBTITLE Button

In DVD mode, press this button to switch language of subtitle.

20. PBC Button

In VCD mode, press this button to display all song menus, work with number button to choose songs.

21. UP, DOWN, LEFT, RIGHT, ENTER Button

When playing MP3, USB, SD returns to song menu, up, down selections can be up / "▲" button or down / "▼" key to select up and down, select and press "ENTER" key to confirm.

The selected tracks can be played. Press the left or right arrow keys to "◀" or "▶" key, can be on the next page function operation.

22. SLOW Button

In audio mode, press this button to slow backward and slow forward.

23. ANGLE Button

In DVD mode, press this button to change play angle.

24. SETUP Button

In audio mode, press this button to choose different set items.

25. OSD Display

Press this button to display the title chapter and the left time.

26. ZOOM Button

In DVD/VCD mode, press this button to ZOOM in.

27. MENU Button

Press button to back to the main menu.

28. DSP

Press this button to show the time.

BATTERY CHANGE

When control distance of remote control becomes shorter or no function, please change battery. Please confirm polarity before change.

One hand press stopper, then pull out battery.

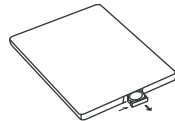

Put battery into controller.

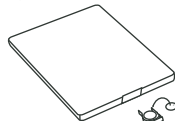

Insert battery holder into controller.

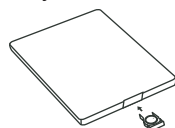

Touch screen Calibration

✦ Please follow the below instructions to calibrate when there is no touch or touch is not accurate.

Step 1: Press the mode button in the unit to switch to DVD mode.

Step 2: Insert a DVD disc, after DVD is loaded, press the stop button "⏏" as show in picture (1). in the remote short, the unit will display as show in picture (2).



Picture (1)



Picture (2)

Step 3: Press "ZOOM" in the remote as show in picture (3), the unit will display as show in picture (4).

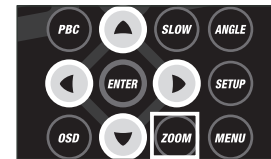

Picture (3)



Picture (4)

Step 4: Press "▲" button in the remote and then quickly press "▼" button as show in picture (5) and you will enter the touch calibration interface as show in picture (6).

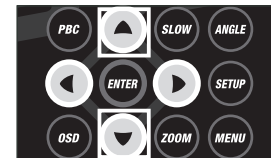

Picture (5)



Picture (6)

Step 15: Use the touch pen to touch top left corner, top right corner, down right corner, down left corner, when the cross cursor stop at each corner, touch the center of the cursor. Then the panel will display OK and leave the calibration interface and the unit regained touch as show in picture (7).



Picture (7)

Audio setting

Click  icon on setup interface to access audio setting interface, as shown in right (PIC 1) diagram:
You can turn on or turn off the existing functions on audio setting interface and adjust the rearview volume.

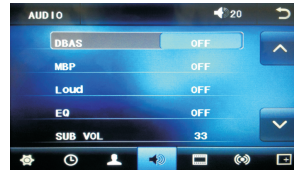

PIC 1



Video setting

Click  icon on setup interface to access video setting interface, as shown in right (PIC 2) diagram:
At video setting interface, you can adjust brightness, contrast, saturation and hue of the video.



PIC 2

Radio setting

Click on  in setting interface, input password [123456] to enter as shown in right (PIC 3) diagram:
Touch [America 1] icon in the radio interface,  icon will popup, click on it to choose radio region



PIC 3

Touch calibration

If touch calibration error occurs, you can adjust the touch coordinate by “Touch calibration”.



Click  icon on setup interface, input password [888888] to confirm to access touch calibration interface, as shown in right (PIC 4) diagram:



PIC 4

Touching methods

Use touch pen to click the center of “+” icon, and move along with center of “+” icon so as to calibrate the screen. It shall automatically save data and exit after screen calibration. Please accurately click all positions on screen, or the accuracy of touch calibration shall be affected.

When the ignition switch is put in ACC or ON position, Press [] button on the front panel to turn on the unit. After the host starts, hold [] button for 3 seconds, the host will turn off.

Access main interface

Turned on, the interface to return the icon to switch to the main interface. As shown below:



Touch the function icons so as to access the corresponding function operations.

USB/SD Card Operation

When there is a USB device/SD card connected, the unit can conduct the playback of audio/video/image files in the USB device/SD card.

Insert/Eject USB storage device

1. Connect a U disc recorded with media information to the unit by a USB connecting cable.
2. When there is a need to eject the USB device, exit the USB device playback screen first, and then take out the device.

Insert/eject SD card

1. Insert a SD card recorded with media information into the SD card slot in the unit correctly until it is locked.
2. When pulling out the SD card, exit SD card playing state first, then press the SD card and it shall pop up after unlocking.

Enter/exit

Insert a USB storage device or SD card to automatically play data contained in it. If the unit has connected with a USB device or SD card, touch [USB] icon in the multimedia interface to enter into the external storage playback interface; Touch [SD] icon to enter into the SD card playback interface. During playback, touch the top center area of the screen to pop up the touch menu, operate touch menu to perform various playback controls.

Play

After SD card/USB removable device being read out, the operation methods are similar to disk operation methods.

Radio Operation

1. Enter/exit

Touch [Radio] icon in the main interface to enter into the radio interface.

Touch  icon to return to main interface, and then touch other function icons so as to exit radio mode.

2. Band selection

Click  icon so as to switch among FM1, FM2, FM3, AM1, AM2 bands.

3. Search/Save radio stations

Short press  icon to browse the stored radio stations.

FM band can save 18 radio stations (Six stations for FM1/FM2/FM3), AM band can save 12 radio stations (Six stations for AM1/AM2).

4. Sound setting

Click  icon to access sound setting interface.

5. Turn on/off the Long/Short-range

Click  icon, the search pattern in the local search (LOC) and remote search (DX) switch between.

LOC feature is turned on after the signal is strong enough only to listen to those in good condition and receiving radio station; DX enabled, you can receive remote weak radio signals.

Note: This function is available only when FM band is selected.

6. Loudness on/off

Click  icon so as to turn on/off loudness function.

7. Stereo on/off

When receiving stereo signals, click  icon to turn on/off stereo.

8. TA (Receive traffic information)

ON: When the traffic station is turned on, the radio will automatically search for traffic stations. After a station is searched, screen displays "TP". Only when traffic information is broadcasted can it be received, after traffic information is completed, the radio will automatically switch to the previous mode.

OFF: Repress [TA] button to close TA function. In other modes, traffic announcement will automatically switch to radio mode, after the traffic announcement is completed, it will automatically switch to the previous mode.

9. AF

Touch the button to turn the AF function on/off. AF function is turned on, When the received station signals become weak, the radio will automatically fine-tune to other frequencies. When receiving an emergency announcing, the screen will display warning message.

10. PTY

Touch the button the screen displays program types, users can search station according to program type. Note: If the unit does not have RDS function, it has no AF/TA/PTY function.



Access setup interface

Click [Setting] icon on main interface to access setup interface.

General setting

Click  icon on setup interface to access general setting interface, as shown in below PIC 1 diagram:

In general setting interface, you can select to turn on or turn off the existing functions. You can set wallpaper and opening picture you like and check version number of DVD/ MCU/TFT, click  icon to browse up/down.

Wallpaper selection

Click [scene1] icon on wallpaper bar [Wallpaper scene1],  direction icon shall pop up, click it to select wallpaper.

Time setting

Click  icon on setup interface to access time setting interface, 12h/24h can interchangeable, as shown in below PIC 2 diagram:

Click [00:11] icon on time bar [Time 00:11] time setting interface shall display, as shown in below PIC 3 diagram:

Click  icon beside hour and minute to separately set hour and minute.



PIC 1

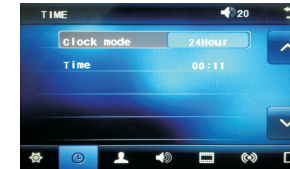

PIC 2

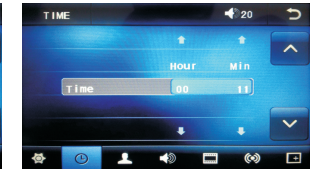

PIC 3

Language setting

During use, you can select your familiar language to display menu by language setup.

Click  icon on setup interface to access language setting interface, as shown in right (PIC 4) diagram:

Click the corresponding [English] icon on the language bar desired to be set so as to switch the language type, when there are more than 3 languages,  direction icon shall pop up, click it to select your familiar language.



PIC 4

Rear view function

In any running state, the video signal can switch to reverse video state when reversing the car, and the system shall return to its initial running state after reversing the car.

⚠ Warning

Do not rely on CCD system completely, please make sure you use direct eyesight while driving. Back rearview system only assists in driving. As the distance range of rearview system is limited, completely relying on the rearview system during driving may cause accidents.

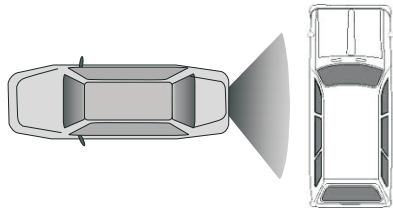

Reverse field simulation



Rearview backup image

1. Play/eject disc

Play disc

Insert the disc into the disc slot with the printing surface up, system will detect the disc and automatically take it in to read and play.

Eject disc

(1) Click [▲] button on the panel to eject the disc.

(2) If a disc has not been took away 15 seconds after it is ejected, system will automatically take in the disc but not play.

⚠ Do not insert two discs or more.

2. DVD/VCD disc playback

During playback of disc, touch the middle lower area of the screen to pop up the touch menu, operate the touch menu to perform various playback controls. (PIC 1)

3. CD Disc Playback

After a CD is inserted, system shall access disk reading state immediately.

When there is a disk in the device, click [Disk] at the main interface so as to access disk reading state.

After the disk being read out, system shall automatically play in sequence.

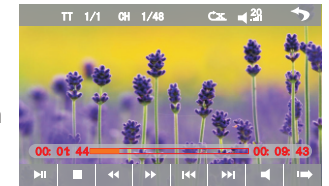

PIC 1

4. MP3/JPEG/MPEG4 disk playing

When the disk contains readable files, such as MP3/JPEG/MPEG4 files, it shall be automatically read out and played after slipping into DVD player.

During playing, touch the screen area and the touch menu shall pop up. Operate the touch menu for various playing.

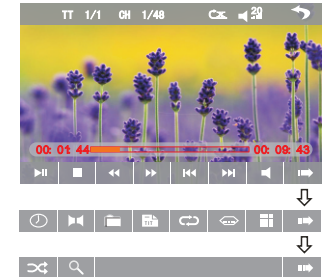

5. Touch Menu Function Description

▶|| Play/pause

Touch the button to pause, retouch it to continue to play.

■ Stop

Touch the button to enter into pre stop status.

⏮ ⏭ Fast forward/backward

Consecutively touch this button to select the speed of fast-forward/fast-backward.

⏮ ⏭ The previous/next song

Touch the button to select the previous/next song.

◀ Volume adjustment button

Touch this button and volume adjustment modulation shall pop up, touch ◀▶ button to adjust the volume.

⇒ ⇒ ⇒ Access next menu

Touch it to access the next menu interface.

Time setting

Touch this button to access time setting interface.

Stereo on/off

Touch it so as to turn on/off stereo.

Return to root menu

Touch this icon, it shall return to root menu of disk in DVD state and access PBC menu playing in VCD state. All chapters in the disk shall be displayed on the interface, touch the chapter icon directly for playing.

Access title menu

Press this button to return to title menu of the disk. Directly click menu bar at title menu interface for playing.

Repeat play

In playing state, touch this button to start repeat play function:

Chapter repeat → Title repeat → Repeat All → Off

 During VCD playing, this function only works when PBC is off.

Language selection

Touch this button to select language.

Digit keyboard

Touch this button and digit keyboard shall appear, click number buttons directly to select tracks for playing.

Switch play order

Touch this button to switch the play order.

Zoom in/Zoom out image

Touch this button to zoom in /zoom out the image.

ST. Wheel setting

1. Click on the [ST. Wheel] icon in the main interface into the ST. Wheel settings interface.
2. The original vehicle to the control line positive, negative with the machine control line in the positive and negative connection.
3. Click the ST. Wheel buttons will appear corresponding operating tips, and fundamental operation prompts the ST. Wheel feature set.
4. Set function to save the settings and click the Confirm icon to confirm.



Note: To modify function settings, repeat procedures 3~4.

To reset functions, click Reset icon, all the settings set before shall be cleared, repeat procedures 3~4 for resetting.

Connect to Media first, touch [Media] icon on main interface to access Media interface, as shown in below diagram:

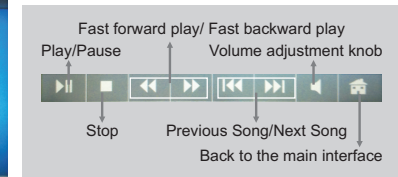

External input operation

Connect the video input plug with external video input jack, and connect the audio input plug with external audio input jack.

Touch [AUX] icon on main interface to access external AUX interface.

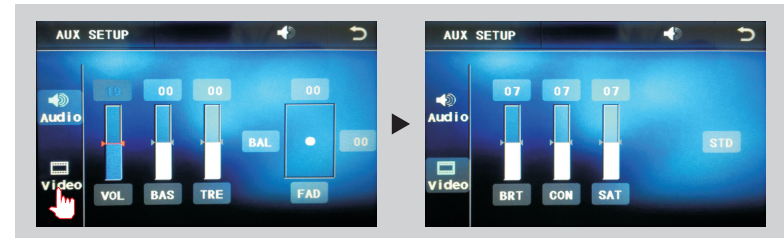

Audio → You can adjust the volume, bass, pitch for input audio. You can adjust the speaker volume by adjusting the front and back, left and right column.

Video → You can adjust the brightness, contrast, saturation and hue for input video. You can also choose the video standard mode.