

WWT
WESTINTRENDS
WWT

DESIGNED IN CALIFORNIA

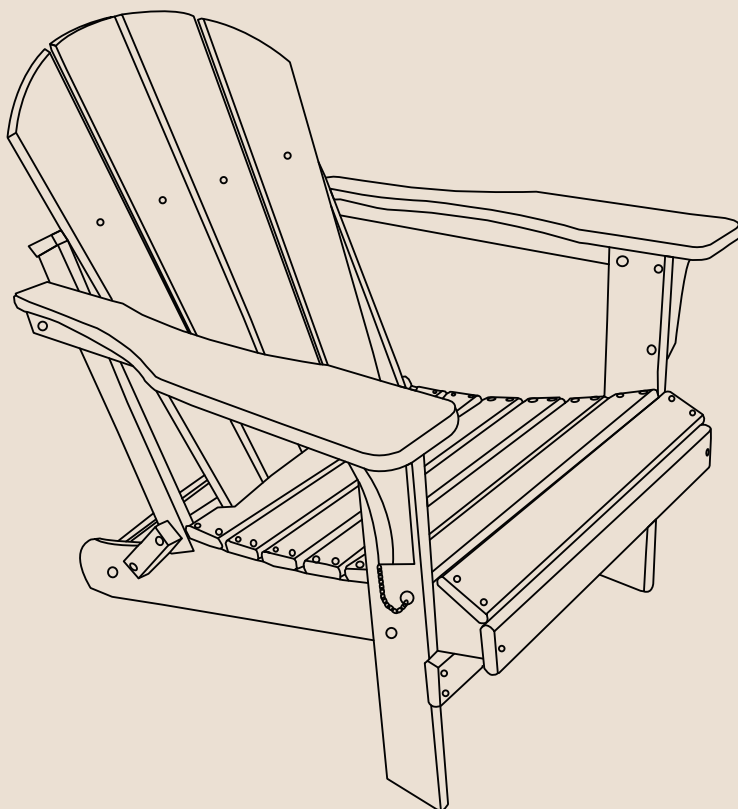

—

OUTDOOR FOLDING POLY
ADIRONDACK CHAIR

—

THANK YOU!

We appreciate you for choosing WestinTrends!

Thank you for letting WestinTrends continue to offer accessible luxury trends, inspired by everyone!

JOIN THE WESTINTRENDS COMMUNITY

Sign up here:

[*https://westintrends.com/welcome*](https://westintrends.com/welcome)



QUESTIONS OR COMMENTS?

If you have questions reach out to
cs@westintrends.com

FOLLOW, SHARE, & LEARN



PRODUCT REGISTRATION

[*https://westintrends.com/apps/product-registration*](https://westintrends.com/apps/product-registration)



ACCESSIBILITY - COMMUNITY - VALUE - SUSTAINABILITY

! NOTICE

Do not overtighten screws. (Insert all screws before tighten screws.)

- Please do not exceed the weight limitations of this item.
- Do not stand on or use any part of this item as a step ladder.
- Firmly secure all bolts, screws and nuts before use.
- Reconfirm that all bolts, screws, and nuts are secure every 90 days.
- Do not use or store this item in the proximity of open flame or flammable/combustible chemicals.
- Be aware that some parts are heavy and have sharp edges.
- Be very careful when folding chair to avoid smashing your hands or fingers.

TOOLS REQUIRED

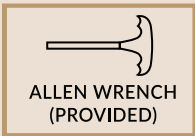

CHAIR
330 LBS
CAPACITY









1 PERSON
ASSEMBLY



UP TO 30 MIN.
ASSEMBLY

HARDWARE

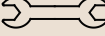
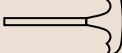
1 M6 x 80mm BOLT  2 PCS	2 M6 x 60mm BOLT  4 PCS	3 M6 x 50mm BOLT  4 PCS	4 M6.3 x 50mm BOLT  2 PCS	5 M6 x 30mm BOLT  4 PCS
6 M6 NUT  8 PCS	7 M6 WASHER  8 PCS	8 WRENCH  1 PC	9 ALLEN WRENCH  1 PC	

PARTS

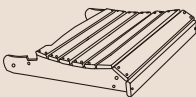
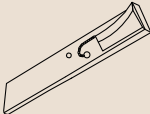
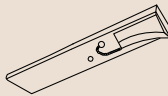
A CHAIR SEAT  1 PC	B RIGHT CHAIR LEG  1 PC	C LEFT CHAIR LEG  1 PC
---	--	---

PARTS

D RIGHT CHAIR ARM



1 PC

E LEFT CHAIR ARM



1 PC

F CHAIR BACKREST

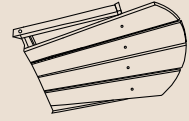

1 PC

G BACK RAIL



1 PC

H FRONT RAIL



1 PC

I LOCKING BLOCK



2 PCS

PRODUCT ASSEMBLY - OVERALL VIEW

1 Look at following overall view of this chair and learn the exact position of each parts to be assembled.

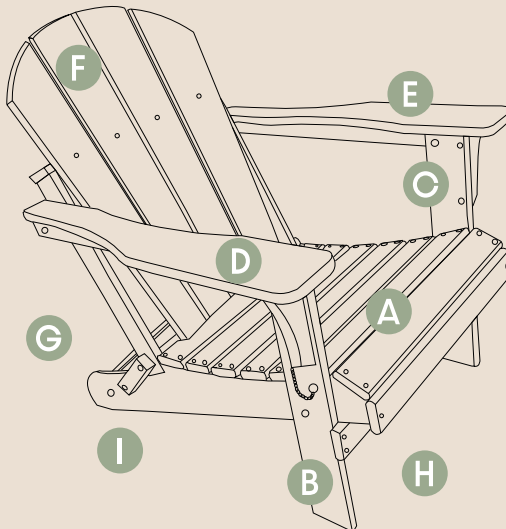

PRODUCT ASSEMBLY

1 Attach Part C Left Chair Leg to Part E Left Chair Arm with 1 pc of Hardware #2 Bolt and Hardware #7 Washer and Hardware #6 Nut. Do same to Part B Right Chair Leg and Part D Right Chair Arm.

Attach the locking stick to chair legs with a screw driver before assembly.

Do not tighten screws too much at this stage.

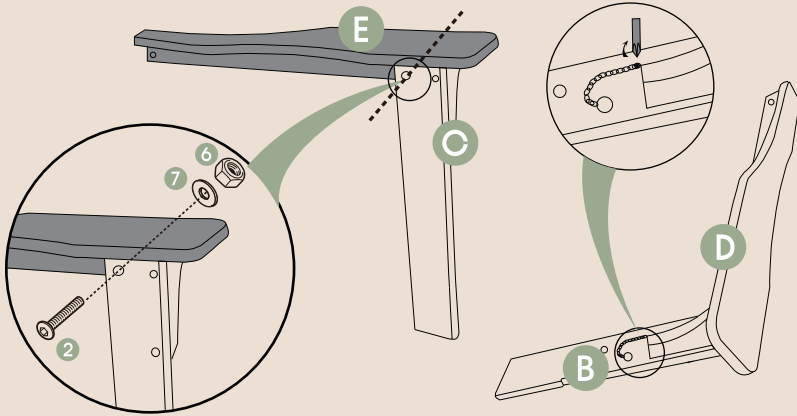

PRODUCT ASSEMBLY

2 Attach Part B Right Chair Leg and Part C Left Chair Leg to Part A Chair Seat with 2 pcs of Hardware #2 Bolt and Hardware #7 Washer and Hardware #6 Nut.

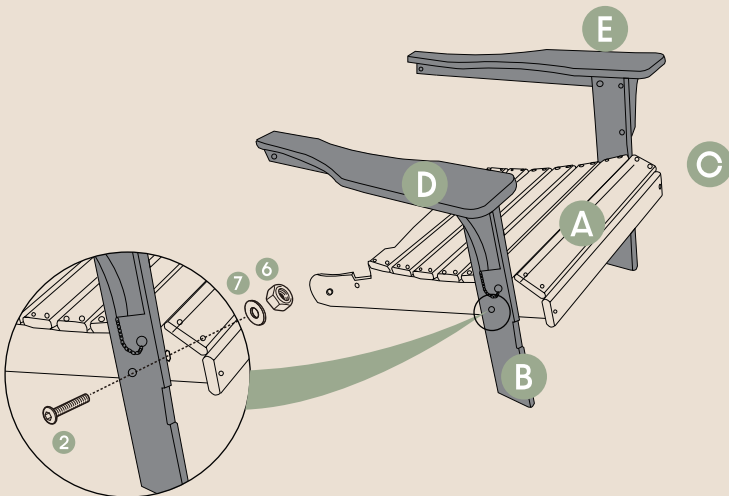

3

Fix Part F Backrest into Part A Chair Seat and then attach Part F Chair Backrest to Part D Right Chair Arm with 1 pc of Hardware #1 Bolt and Hardware #7 Washer and Hardware #6 Nut.

Do the same to attach Part F Backrest to Part E Left Chair Leg.

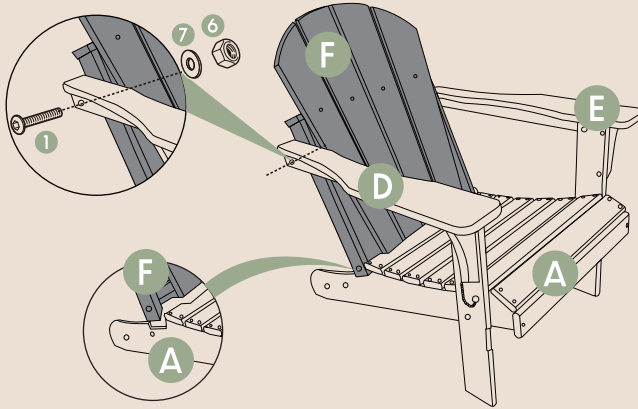

4

Attach Part I Locking Blocks to Part F Chair Backrest (both sides) with 2 pcs of Hardware #4 Bolt and attach Part I Locking Blocks to Part A Chair Seat (both sides) with 2 pcs of Hardware #3 Bolt and Hardware #7 Washer and Hardware #6 Nut.

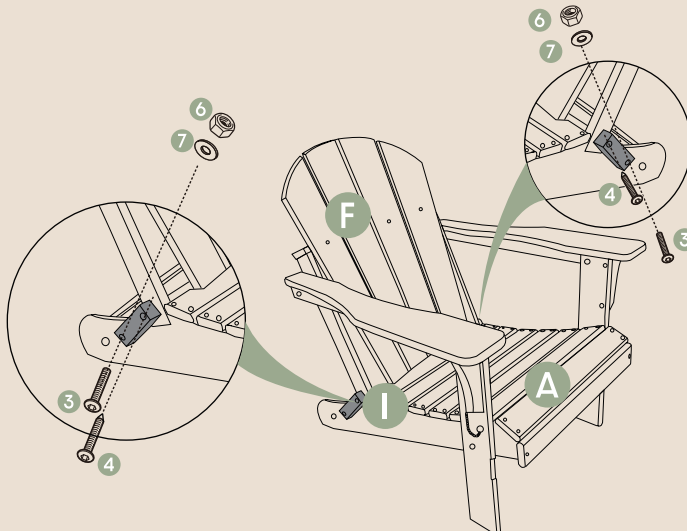

PRODUCT ASSEMBLY

5

Attach Part G Back Rail to Part A Chair Seat with 2 pcs of Hardware #3 Bolt.

Attach Part H Front Rail to Part B Left Chair Leg and Part C Right Chair Leg with 4 pcs of Hardware #5 Bolt.

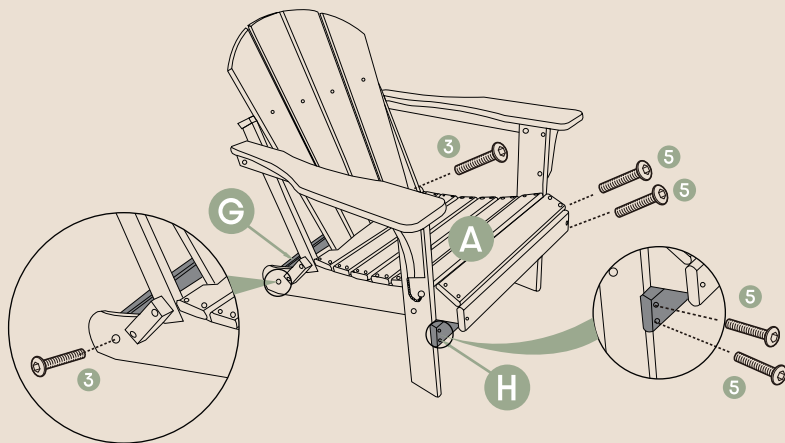

Congratulations! You finished the assembly of this chair.

Pull the stick out of both legs to fold this chair as below.

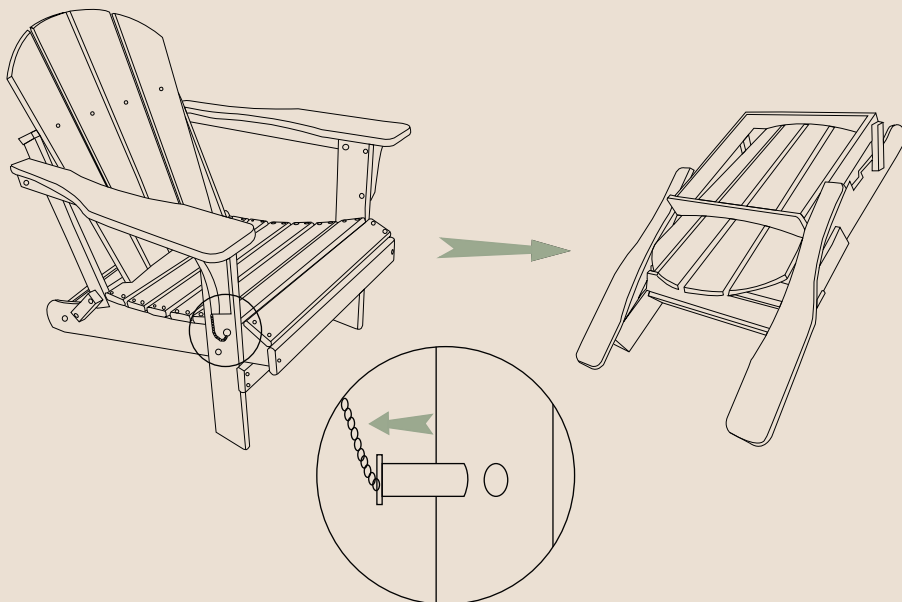

REGISTRATION & REFUND POLICY

<https://westintrends.com/apps/product-registration>



<https://westintrends.com/policies/refund-policy>



HAVING TROUBLE

Not sure how to assemble or missing pieces?

Please contact our Customer Service Team for assistance at cs@westintrends.com

Have Order #, Part # or SKU ready to speed up customer service!

CLEANING TIPS

REGULAR CLEAN: Use a mixture of warm water and mild soap. Gently scrub the surface with a soft bristle brush to remove any dirt or stains.

QUICK CLEAN: You can simply wipe down the HDPE furniture with a damp cloth. The material's resilience makes it resistant to most spills and stains, ensuring a hassle-free maintenance routine.

Regular cleaning not only preserves the aesthetic appeal of your furniture but also helps extend its lifespan.

Pressure washer can be used for seriously deep-cleaning - **DO NOT exceed 1500 PSI** - this will remove debris and dirt.