

DLP® Projector

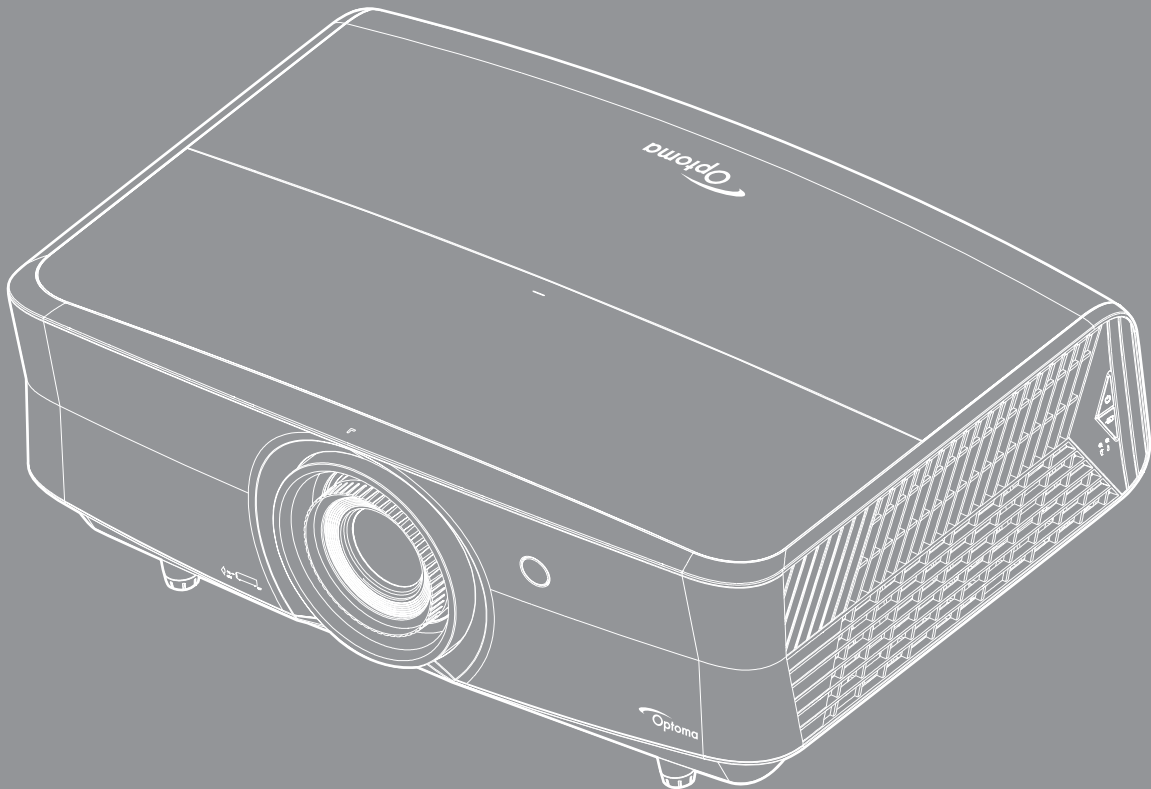

TABLE OF CONTENTS

| | |
|---|-----------|
| SAFETY | 4 |
| <i>Important Safety Instruction.....</i> | <i>4</i> |
| <i>Laser Radiation Safety Information</i> | <i>5</i> |
| <i>3D Safety Information.....</i> | <i>6</i> |
| <i>Copyright.....</i> | <i>6</i> |
| <i>Disclaimer.....</i> | <i>6</i> |
| <i>Trademark Recognition</i> | <i>7</i> |
| <i>FCC.....</i> | <i>7</i> |
| <i>Declaration of Conformity for EU countries</i> | <i>8</i> |
| <i>WEEE.....</i> | <i>8</i> |
| | |
| INTRODUCTION | 9 |
| <i>Package Overview.....</i> | <i>9</i> |
| <i>Standard accessories.....</i> | <i>9</i> |
| <i>Optional accessories.....</i> | <i>9</i> |
| <i>Product Overview</i> | <i>10</i> |
| <i>Connections.....</i> | <i>11</i> |
| <i>Keypad</i> | <i>12</i> |
| <i>Remote control.....</i> | <i>13</i> |
| | |
| SETUP AND INSTALLATION..... | 15 |
| <i>Installing the projector</i> | <i>15</i> |
| <i>Connecting sources to the projector.....</i> | <i>17</i> |
| <i>Adjusting the projector image</i> | <i>18</i> |
| <i>Remote setup</i> | <i>20</i> |
| | |
| USING THE PROJECTOR | 22 |
| <i>Powering on / off the projector.....</i> | <i>22</i> |
| <i>Selecting an input source</i> | <i>23</i> |
| <i>Menu navigation and features</i> | <i>24</i> |
| <i>OSD Menu tree.....</i> | <i>25</i> |
| <i>Display image settings menu.....</i> | <i>33</i> |
| <i>Display 3D menu</i> | <i>37</i> |
| <i>Display aspect ratio menu</i> | <i>37</i> |
| <i>Display edge mask menu</i> | <i>39</i> |
| <i>Display digital zoom menu.....</i> | <i>39</i> |
| <i>Display image shift menu</i> | <i>39</i> |
| <i>Audio internal speaker menu.....</i> | <i>40</i> |
| <i>Audio mute menu</i> | <i>40</i> |
| <i>Audio volume menu.....</i> | <i>40</i> |
| <i>Audio audio input menu.....</i> | <i>40</i> |
| <i>Audio audio out menu.....</i> | <i>40</i> |
| <i>Setup projection menu.....</i> | <i>41</i> |

| | |
|--|----|
| <i>Setup filter settings menu</i> | 41 |
| <i>Setup power settings menu</i> | 41 |
| <i>Setup security menu</i> | 42 |
| <i>Setup test pattern menu</i> | 42 |
| <i>Setup remote settings menu</i> | 42 |
| <i>Setup projector ID menu</i> | 42 |
| <i>Setup 12V trigger menu</i> | 43 |
| <i>Setup options menu</i> | 43 |
| <i>Setup reset OSD menu</i> | 44 |
| <i>Network LAN menu</i> | 44 |
| <i>Network control menu</i> | 45 |
| <i>Setup network control settings menu</i> | 46 |
| <i>Info menu</i> | 51 |

MAINTENANCE..... 52

| | |
|--|----|
| <i>Installing and cleaning the dust filter</i> | 52 |
|--|----|

ADDITIONAL INFORMATION..... 53

| | |
|--|----|
| <i>Compatible resolutions</i> | 53 |
| <i>Image size and projection distance</i> | 56 |
| <i>Projector dimensions and ceiling mount installation</i> | 57 |
| <i>IR remote codes</i> | 58 |
| <i>Troubleshooting</i> | 62 |
| <i>Warning indicators</i> | 64 |
| <i>Specifications</i> | 66 |
| <i>Optoma global offices</i> | 67 |

SAFETY

| | |
|---|---|
|  | The lightning flash with arrow head within an equilateral triangle is intended to alert the user to the presence of uninsulated "dangerous voltage" within the product's enclosure that may be of sufficient magnitude to constitute a risk of electric shock to persons. |
|  | The exclamation point within an equilateral triangle is intended to alert the user to the presence of important operating and maintenance (servicing) instructions in the literature accompanying the appliance. |

Please follow all warnings, precautions and maintenance as recommended in this user's guide.

Important Safety Instruction

- Do not block any ventilation openings. To ensure reliable operation of the projector and to protect from over heating, it is recommended to install the projector in a location that does not block ventilation. As an example, do not place the projector on a crowded coffee table, sofa, bed, etc. Do not put the projector in an enclosure such as a book case or a cabinet that restricts air flow.
- To reduce the risk of fire and/or electric shock, do not expose the projector to rain or moisture. Do not install near heat sources such as radiators, heaters, stoves or any other apparatus such as amplifiers that emits heat.
- Do not let objects or liquids enter the projector. They may touch dangerous voltage points and short out parts that could result in fire or electric shock.
- Do not use under the following conditions:
 - In extremely hot, cold or humid environments.
 - (i) Ensure that the ambient room temperature is within 5°C ~ 40°C
 - (ii) Relative humidity is 10% ~ 85%
 - In areas susceptible to excessive dust and dirt.
 - Near any appliance generating a strong magnetic field.
 - In direct sunlight.
- Do not use the unit if it has been physically damaged or abused. Physical damage/abuse would be (but not limited to):
 - Unit has been dropped.
 - Power supply cord or plug has been damaged.
 - Liquid has been spilled on to the projector.
 - Projector has been exposed to rain or moisture.
 - Something has fallen in the projector or something is loose inside.
- Do not place the projector on an unstable surface. The projector may fall over resulting in injury or the projector may become damaged.
- Do not block the light coming out of the projector lens when in operation. The light will heat the object and may melt, cause burns or start a fire.
- Please do not open or disassemble the projector as this may cause electric shock.
- Do not attempt to service the unit yourself. Opening or removing covers may expose you to dangerous voltages or other hazards. Please call Optoma before you send the unit for repair.
- See projector enclosure for safety related markings.
- The unit should only be repaired by authorized service personnel.
- Only use attachments/accessories specified by the manufacturer.
- Do not look into straight into the projector lens during operation. The bright light may harm your eyes.
- This projector will detect the life of the light source itself.

- When switching the projector off, please ensure the cooling cycle has been completed before disconnecting power. Allow 90 seconds for the projector to cool down.
- Turn off and unplug the power plug from the AC outlet before cleaning the product.
- Use a soft dry cloth with mild detergent to clean the display housing. Do not use abrasive cleaners, waxes or solvents to clean the unit.
- Disconnect the power plug from AC outlet if the product is not being used for a long period of time.
- Do not setup the projector in places where it might be subjected to vibration or shock.
- Do not touch the lens with bare hands.
- Remove battery/batteries from remote control before storage. If the battery/batteries are left in the remote for long periods, they may leak.
- Do not use or store the projector in places where smoke from oil or cigarettes may be present, as it can adversely affect the quality of the projector performance.
- Please follow the correct projector orientation installation as non standard installation may affect the projector performance.
- Use a power strip and or surge protector. As power outages and brown-outs can KILL devices.

Laser Radiation Safety Information

- Complies with 21 CFR 1040.10 and 1040.11 except for conformance as a Risk Group 2 LIP as defined in IEC 62471-5:Ed. 1.0. For more information see Laser Notice No. 57, dated May 8, 2019

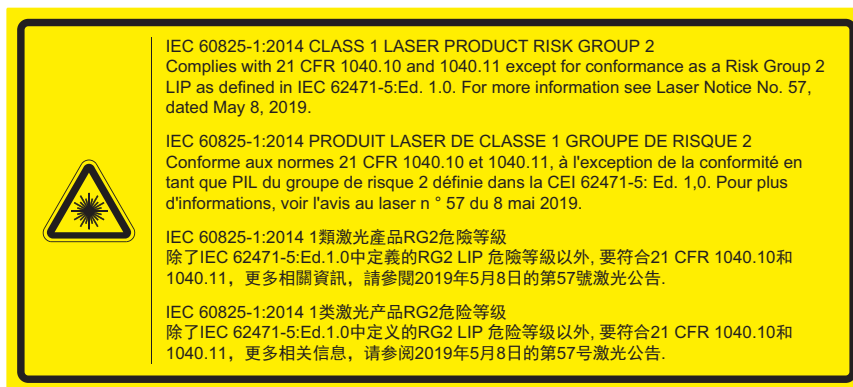

Failure to comply with the following could result in death or serious injury.

- This projector has built-in Class 4 laser module. Disassembly or modification is very dangerous and should never be attempted.
- Any operation or adjustment not specifically instructed by the user's guide creates the risk of hazardous laser radiation exposure.
- Do not open or disassemble the projector as this may cause damage by the exposure of laser radiation.
- Do not stare into beam when the projector is on. The bright light may result in permanent eye damage.
- When turning on the projector, make sure no one within projection range is looking at the lens.
- Without following the control, adjustment or operation procedure may cause damage by the exposure of laser radiation.
- Adequate instructions for assembly, operation, and maintenance, including clear warnings concerning precautions to avoid possible exposure to laser.

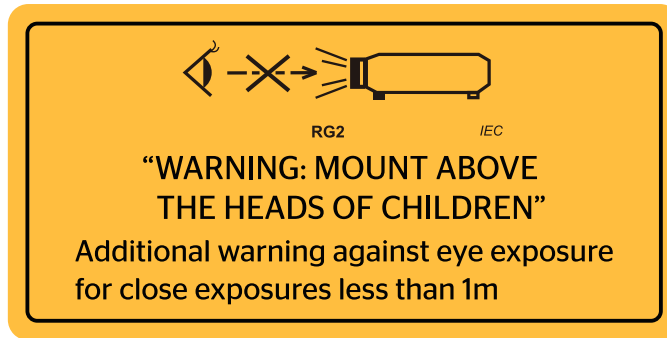

- IEC 60825-1: 2014 Class 1 RG2
IEC 62471-5:2015 RG2

- Additional instructions to supervise children, no staring, and not use optical aids.
- Additional instructions to install above the reach of children.
- Notice is given to supervise children and to never allow them to stare into the projector beam at any distance from the projector.
- Notice is given to use caution when using the remote control for starting the projector while in front of the projection lens.
- Notice is given to the user to avoid the use of optical aids such as binoculars or telescopes inside the beam.
- As with any bright light source, do not stare into the beam, RG2 IEC 62471-5:2015.
- **WARNING: MOUNT ABOVE THE HEADS OF CHILDREN.** The use of a ceiling mount is recommended with this product to place it above the eyes of children.

3D Safety Information

Please follow all warnings and precautions as recommended before you or your child use the 3D function.

Warning

Children and teenagers may be more susceptible to health issues associated with viewing in 3D and should be closely supervised when viewing these images.

Photosensitive Seizure Warning and Other Health Risks

- Some viewers may experience an epileptic seizure or stroke when exposed to certain flashing images or lights contained in certain Projector pictures or video games. If you suffer from, or have a family history of epilepsy or strokes, please consult with a medical specialist before using the 3D function.
- Even those without a personal or family history of epilepsy or stroke may have an undiagnosed condition that can cause photosensitive epileptic seizures.
- Pregnant women, the elderly, sufferers of serious medical conditions, those who are sleep deprived or under the influence of alcohol should avoid utilizing the unit's 3D functionality.
- If you experience any of the following symptoms, stop viewing 3D pictures immediately and consult a medical specialist: (1) altered vision; (2) light-headedness; (3) dizziness; (4) involuntary movements such as eye or muscle twitching; (5) confusion; (6) nausea; (7) loss of awareness; (8) convulsions; (9) cramps; and/ or (10) disorientation. Children and teenagers may be more likely than adults to experience these symptoms. Parents should monitor their children and ask whether they are experiencing these symptoms.
- Watching 3D projection may also cause motion sickness, perceptual after effects, disorientation, eye strain and decreased postural stability. It is recommended that users take frequent breaks to lessen the potential of these effects. If your eyes show signs of fatigue or dryness or if you have any of the above symptoms, immediately discontinue use of this device and do not resume using it for at least thirty minutes after the symptoms have subsided.
- Watching 3D projection while sitting too close to the screen for an extended period of time may damage your eyesight. The ideal viewing distance should be at least three times the screen height. It is recommended that the viewer's eyes are level with the screen.
- Watching 3D projection while wearing 3D glasses for an extended period of time may cause a headache or fatigue. If you experience a headache, fatigue or dizziness, stop viewing the 3D

projection and rest.

- Do not use the 3D glasses for any other purpose than for watching 3D projection.
- Wearing the 3D glasses for any other purpose (as general spectacles, sunglasses, protective goggles, etc.) may be physically harmful to you and may weaken your eyesight.
- Viewing in 3D projection may cause disorientation for some viewers. Accordingly, DO NOT place your 3D PROJECTOR near open stairwells, cables, balconies, or other objects that can be tripped over, run into, knocked down, broken or fallen over.

Copyright

This publication, including all photographs, illustrations and software, is protected under international copyright laws, with all rights reserved. Neither this manual, nor any of the material contained herein, may be reproduced without written consent of the author.

© Copyright 2019

Disclaimer

The information in this document is subject to change without notice. The manufacturer makes no representations or warranties with respect to the contents hereof and specifically disclaims any implied warranties of merchantability or fitness for any particular purpose. The manufacturer reserves the right to revise this publication and to make changes from time to time in the content hereof without obligation of the manufacturer to notify any person of such revision or changes.

Trademark Recognition

Kensington is a U.S. registered trademark of ACCO Brand Corporation with issued registrations and pending applications in other countries throughout the world.

HDMI, the HDMI Logo, and High-Definition Multimedia Interface are trademarks or registered trademarks of HDMI Licensing LLC in the United States and other countries.

DLP®, DLP Link and the DLP logo are registered trademarks of Texas Instruments and BrilliantColor™ is a trademark of Texas Instruments.

MHL, Mobile High-Definition Link and the MHL Logo are trademarks or registered trademarks of MHL Licensing, LLC.

All other product names used in this manual are the properties of their respective owners and are Acknowledged.

FCC

This device has been tested and found to comply with the limits for a Class B digital device pursuant to Part 15 of the FCC rules. These limits are designed to provide reasonable protection against harmful interference in a residential installation. This device generates, uses and can radiate radio frequency energy and, if not installed and used in accordance with the instructions, may cause harmful interference to radio communications.

However, there is no guarantee that interference will not occur in a particular installation. If this device does cause harmful interference to radio or television reception, which can be determined by turning the device off and on is encouraged to try to correct the interference by one or more of the following measures:

- Reorient or relocate the receiving antenna.
- Increase the separation between the device and receiver.
- Connect the device into an outlet on a circuit different from that to which the receiver is connected.
- Consult the dealer or an experienced radio/television technician for help.

Notice: Shielded cables

All connections to other computing devices must be made using shielded cables to maintain compliance with FCC regulations.

Caution

Changes or modifications not expressly approved by the manufacturer could void the user's authority, which is granted by the Federal Communications Commission, to operate this projector.

Operation Conditions

This device complies with Part 15 of the FCC Rules. Operation is subject to the following two conditions:

1. This device may not cause harmful interference and
2. This device must accept any interference received, including interference that may cause undesired operation.

Notice: Canadian users

This Class B digital apparatus complies with Canadian ICES-003.

Remarque à l'intention des utilisateurs canadiens

Cet appareil numérique de la classe B est conforme à la norme NMB-003 du Canada.

Declaration of Conformity for EU countries

- EMC Directive 2014/30/EU (including amendments)
- Low Voltage Directive 2014/35/EU
- RED 2014/53/EU (if product has RF function)

WEEE



Disposal instructions

Do not throw this electronic device into the trash when discarding. To minimize pollution and ensure utmost protection of the global environment, please recycle it.

INTRODUCTION

Package Overview

Carefully unpack and verify that you have the items listed below under standard accessories. Some of the items under optional accessories may not be available depending on the model, specification and your region of purchase. Please check with your place of purchase. Some accessories may vary from region to region.

The warranty card is only supplied in some specific regions. Please consult your dealer for detailed information.

Standard accessories

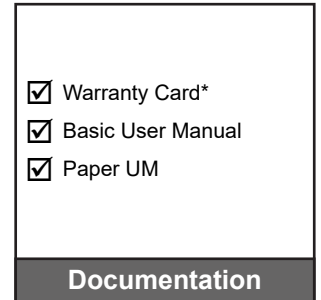
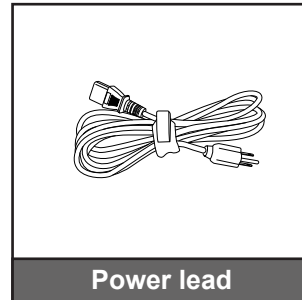
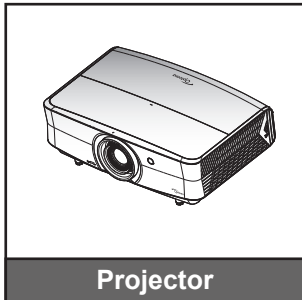

Note:

- *The remote control is shipped with the battery.*
- **For European warranty Information, please visit www.optoma.com.*

Optional accessories

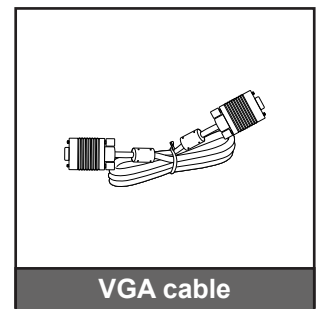
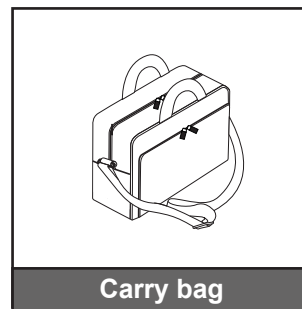
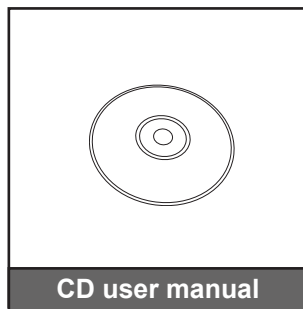
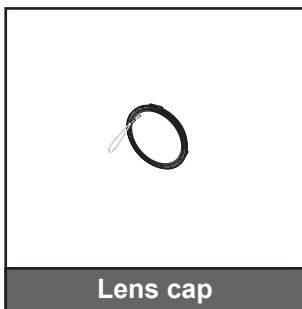

Note:

- *Optional accessories vary depending on model, specification and region.*

INTRODUCTION

Product Overview

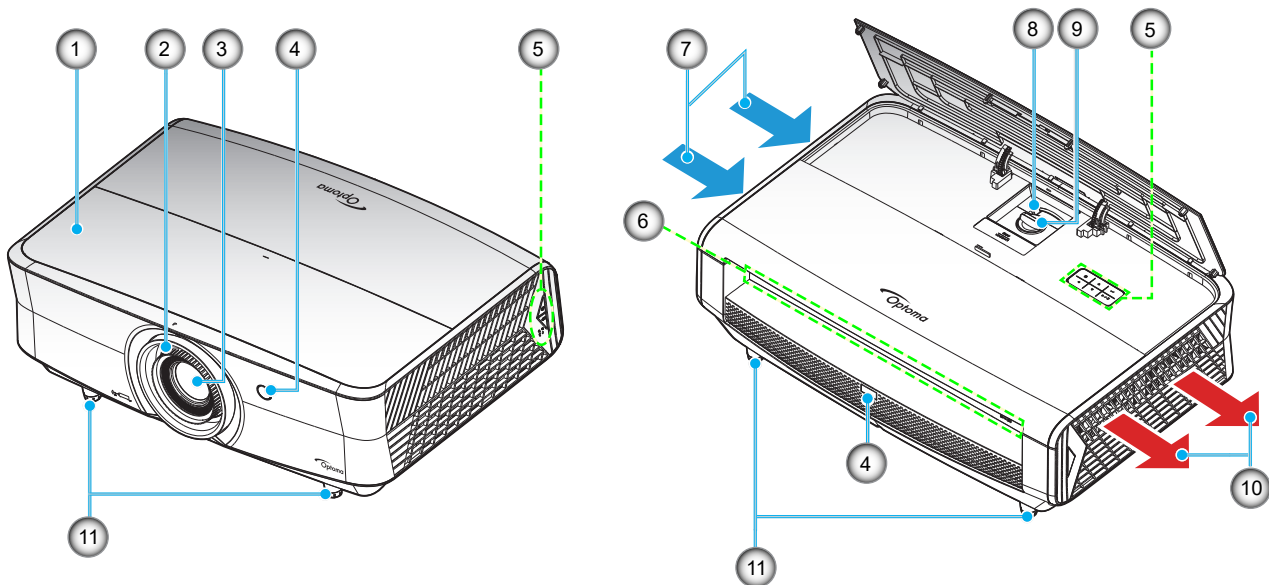

Note:

- Do not block projector intake and exhaust vents.
- When operating the projector in an enclosed space, allow at least 30 cm clearance around the intake and exhaust vents.

| No | Item | No | Item |
|----|----------------|-----|----------------------|
| 1. | Top Cover | 7. | Ventilation (inlet) |
| 2. | Focus Ring | 8. | Zoom Lever |
| 3. | Lens | 9. | Lens Shift Dial |
| 4. | IR Receiver | 10. | Ventilation (outlet) |
| 5. | Keypad | 11. | Tilt-Adjustment Foot |
| 6. | Input / Output | | |

INTRODUCTION

Connections

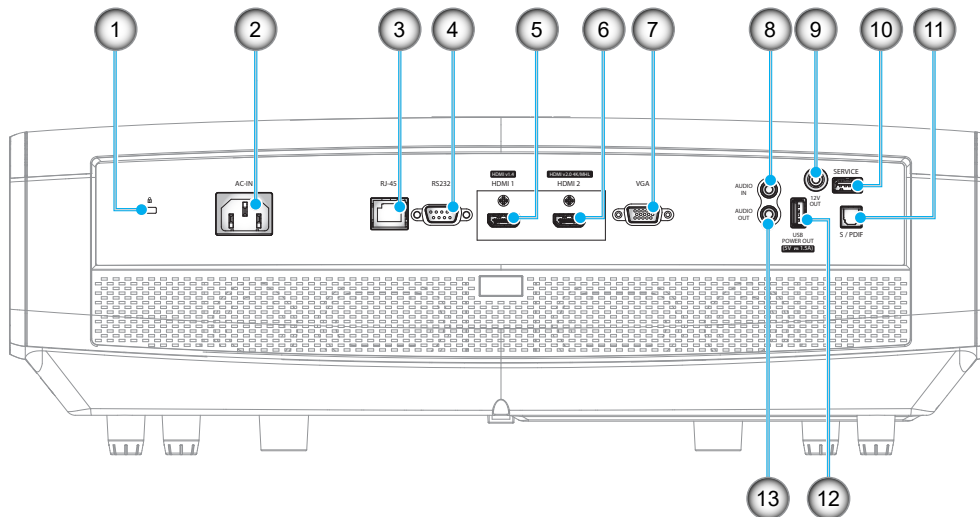

| No | Item | No | Item |
|----|--|-----|--------------------------------|
| 1. | Kensington™ Lock Port | 8. | AUDIO IN Connector |
| 2. | Power Socket | 9. | 12V OUT Connector |
| 3. | RJ-45 Connector | 10. | Service Connector (*2) |
| 4. | RS232 Connector | 11. | S/PDIF Connector |
| 5. | HDMI 1 (v1.4) Connector | 12. | USB Power Out (5V---1.5A) (*3) |
| 6. | HDMI 2 (v2.0) 4K / MHL Connector (*1,*3) | 13. | AUDIO OUT Connector |
| 7. | VGA Connector | | |

Note:

- (*1)HDMI 2 connector supports HDCP2.2 and MHL V2.2.
- (*2)For firmware upgrade.
- (*3)MHL and USB DC5V are alternately powered on. For example, USB DC 5V is off when MHL is on or DC 5V is on when MHL is off.

INTRODUCTION

Keypad

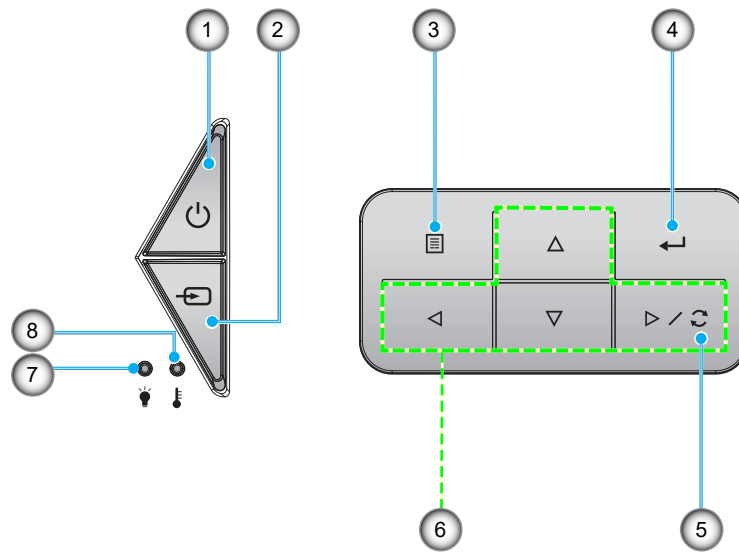

| No | Item |
|----|--------------------------|
| 1. | Power and On/Standby LED |
| 2. | Source |
| 3. | Menu |
| 4. | Enter |

| No | Item |
|----|------------------------------|
| 5. | Re-Sync |
| 6. | Four Directional Select Keys |
| 7. | Laser LED |
| 8. | Temp LED |

INTRODUCTION

Remote control

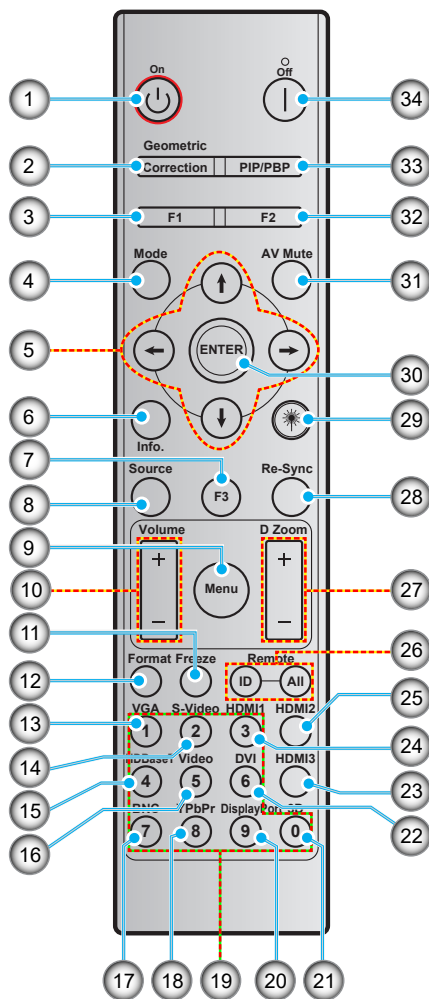

| No | Item | No | Item |
|-----|-----------------------------------|-----|-----------------------------------|
| 1. | Power on | 18. | YPbPr (not supported) |
| 2. | Geometric Correction | 19. | Numeric keypad (0-9) |
| 3. | Function button (F1) (Assignable) | 20. | Display port (not supported) |
| 4. | Mode | 21. | 3D |
| 5. | Four directional select keys | 22. | DVI (not supported) |
| 6. | Information | 23. | HDMI3 (not supported) |
| 7. | Function button (F3) (Assignable) | 24. | HDMI1 |
| 8. | Source | 25. | HDMI2 |
| 9. | Menu | 26. | Remote ID / Remote all |
| 10. | Volume - / + | 27. | Digital Zoom - / + |
| 11. | Freeze | 28. | Re-sync |
| 12. | Format (Aspect Ratio) | 29. | Laser (not supported) |
| 13. | VGA | 30. | Enter |
| 14. | S-Video | 31. | AV Mute |
| 15. | HDBase-T | 32. | Function button (F2) (Assignable) |
| 16. | Video | 33. | PIP/PBP (not supported) |
| 17. | BNC (not supported) | 34. | Power off |

Note: Some keys may have no function for models that do not support these features.

SETUP AND INSTALLATION

Installing the projector

Your projector is designed to be installed in one of four possible positions.

Your room layout or personal preference will dictate which installation location you select. Take into consideration the size and position of your screen, the location of a suitable power outlet, as well as the location and distance between the projector and the rest of your equipment.

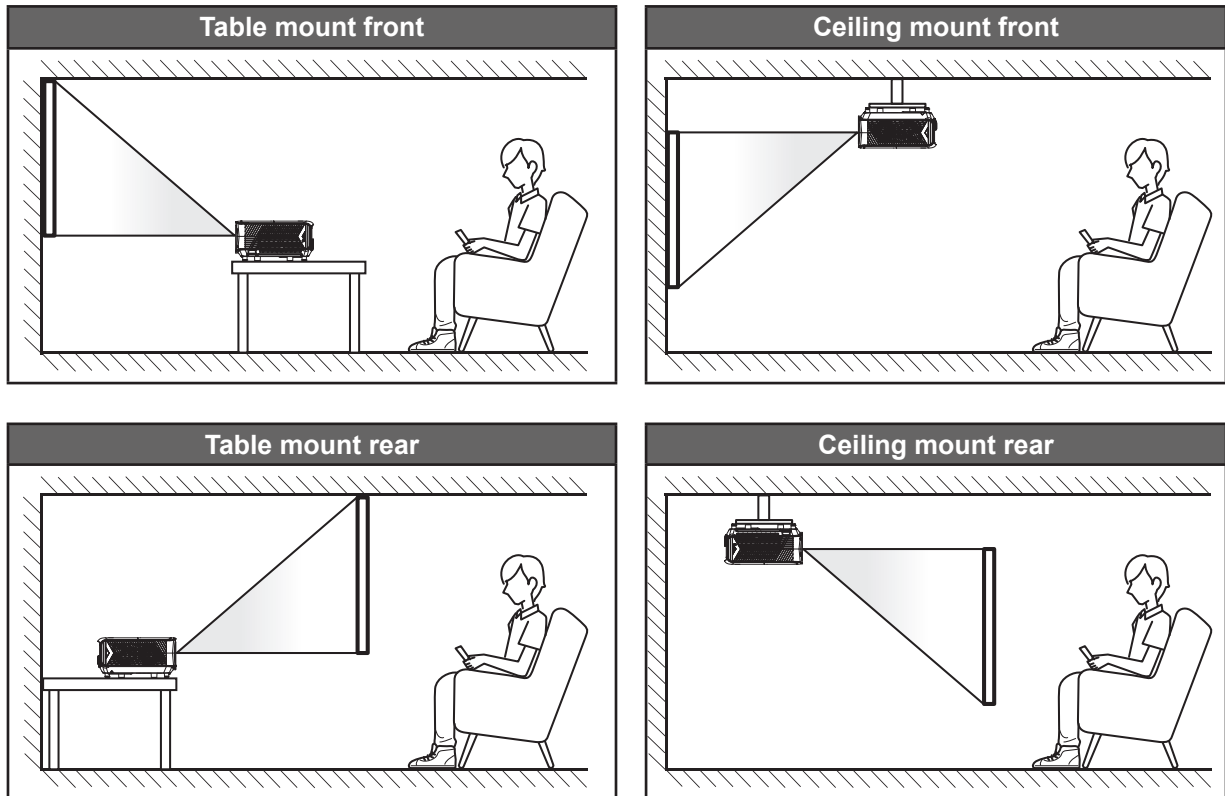

Projector should be placed flat on a surface and 90 degrees / perpendicular to the screen.

- How to determine projector location for a given screen size, please refer to distance table on page 56.
- How to determine screen size for a given distance, please refer to distance table on page 56.

Note: *The further away the projector is placed from the screen the projected image size increases and vertical offset also increases proportionally.*

IMPORTANT!

Do not operate the projector in any orientation other than table top or ceiling mount. The projector should be horizontal and not tilted either forwards/backwards or left/right. Any other orientation will invalidate the warranty and may shorten the lifetime of the projector light source or the projector itself. For none standard installation advise please contact Optoma.

SETUP AND INSTALLATION

Projector installation notice

- Allow at least 30 cm clearance around the exhaust vent.

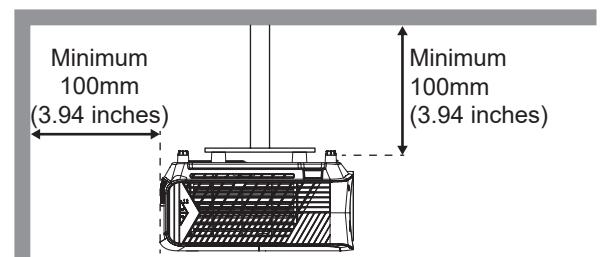
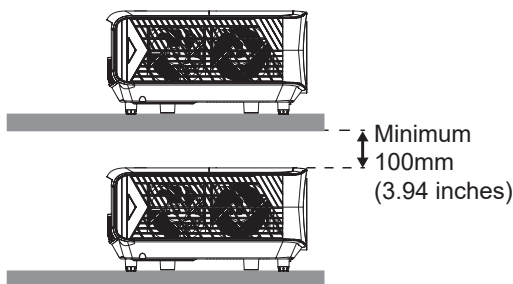
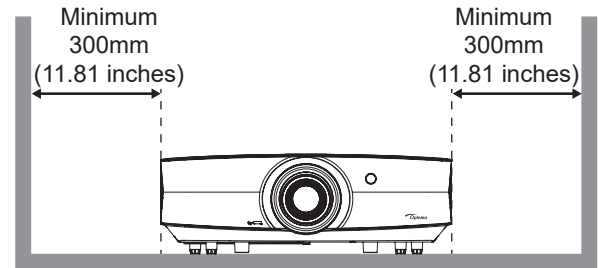
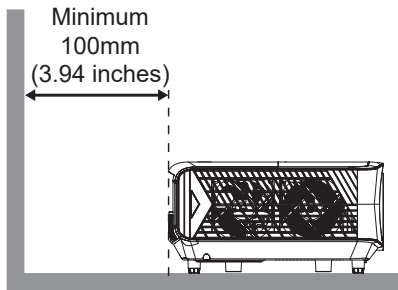

- Ensure that the intake vents do not recycle hot air from the exhaust vent.
- When operating the projector in an enclosed space, ensure that the surrounding air temperature within the enclosure does not exceed operation temperature while the projector is running, and the air intake and exhaust vents are unobstructed.
- All enclosures should pass a certified thermal evaluation to ensure that the projector does not recycle exhaust air, as this may cause the device to shutdown even if the enclosure temperature is within the acceptable operation temperature range.

SETUP AND INSTALLATION

Connecting sources to the projector

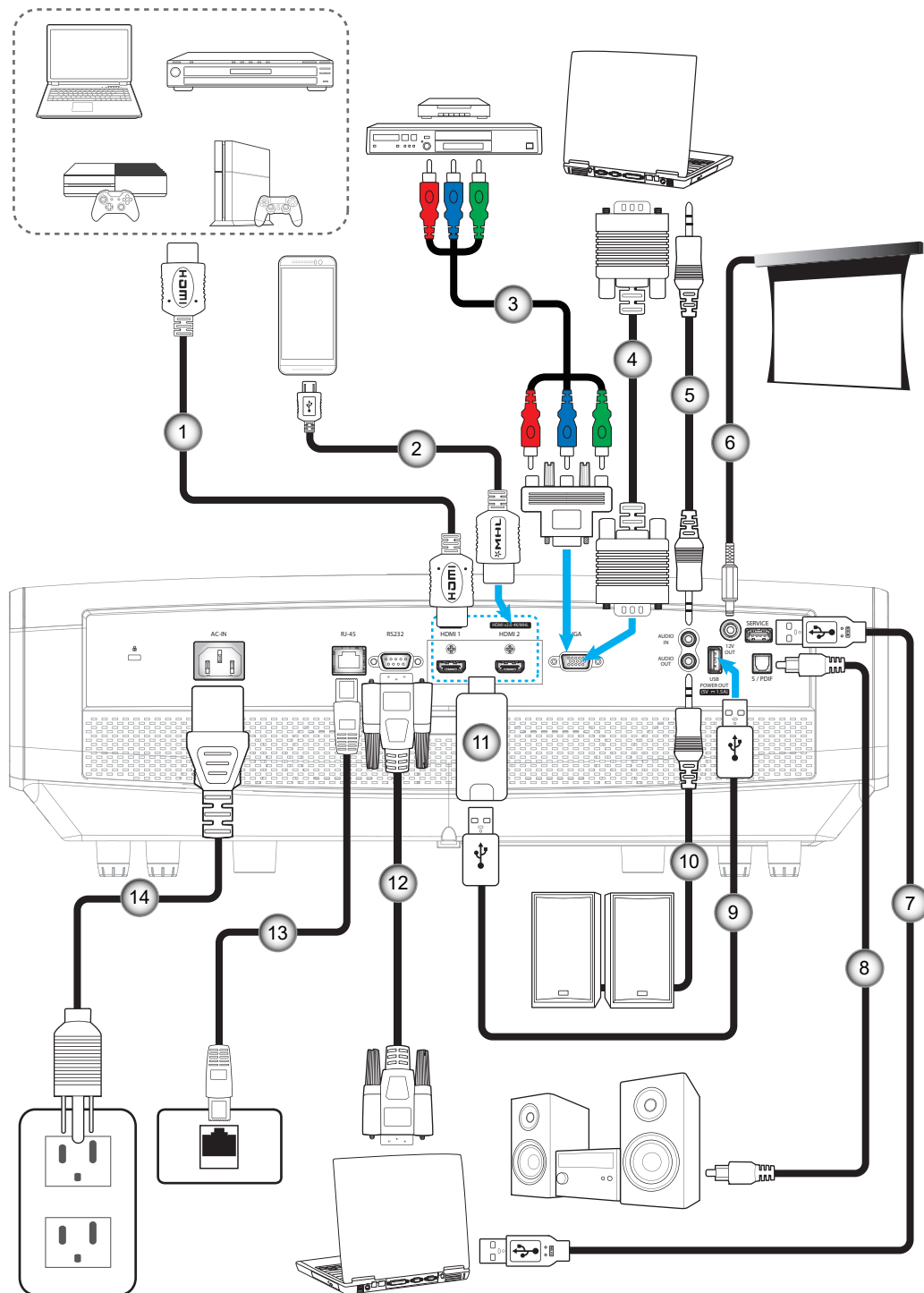

| No | Item | No | Item |
|----|---------------------|-----|------------------|
| 1. | HDMI Cable | 8. | S/PDIF Out Cable |
| 2. | HDMI / MHL Cable | 9. | USB Power Cable |
| 3. | RCA Component Cable | 10. | Audio Out Cable |
| 4. | VGA In Cable | 11. | HDMI Dongle |
| 5. | Audio In Cable | 12. | RS232 Cable |
| 6. | 12V DC Jack | 13. | RJ-45 Cable |
| 7. | USB Cable | 14. | Power Cord |

SETUP AND INSTALLATION

Adjusting the projector image

Image height

The projector is equipped with elevator feet for adjusting the image height.

1. Locate the adjustable foot you wish to adjust on the underside of the projector.
2. Rotate the adjustable foot clockwise or counterclockwise to raise or lower the projector.

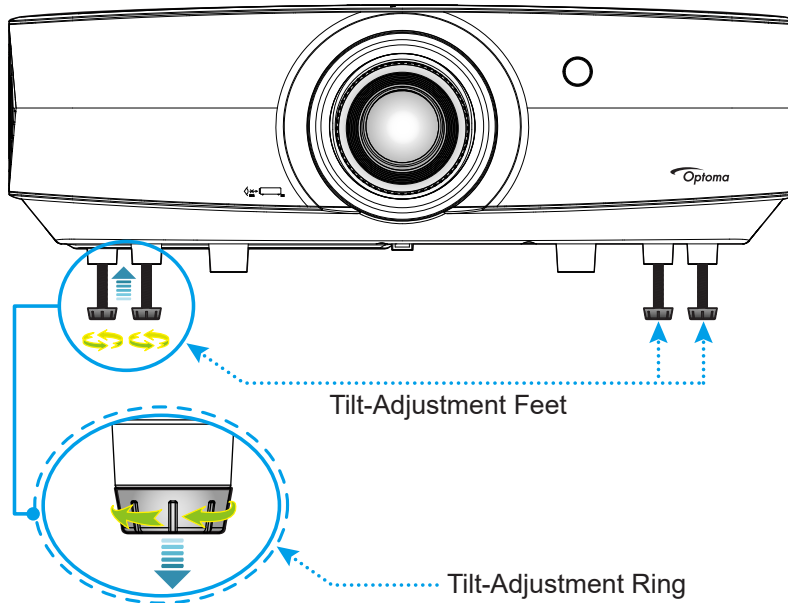

Zoom, lens shift, and focus

- To adjust the image size and position, do the following:
 - a. Push down firmly on the middle of the top cover to unlock the latch. Then open the top cover.

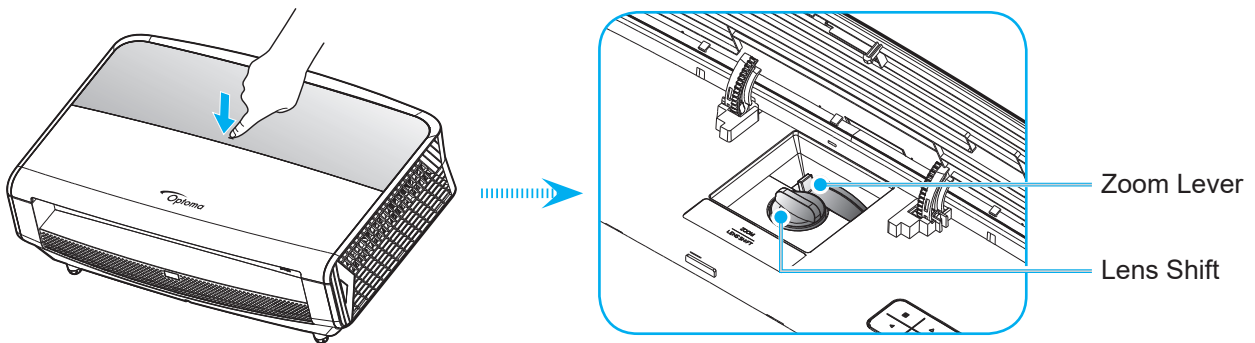

- b. To adjust the image size, turn the zoom lever clockwise or counterclockwise to increase or decrease the projected image size.
- c. To adjust the image position, turn the lens shift dial clockwise or counterclockwise to adjust the position of the projected image vertically.

SETUP AND INSTALLATION

- To adjust the focus, turn the focus ring clockwise or counterclockwise until the image is sharp and legible.

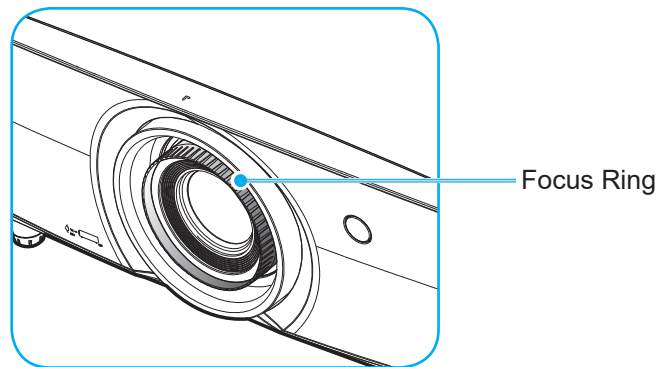

Note: *The projector will focus at a distance of 1.3m to 9.3m.*

SETUP AND INSTALLATION

Remote setup

Installing / replacing the batteries

Two AAA size batteries are supplied for the remote control.

1. Remove the battery cover on the back of the remote control.
2. Insert AAA batteries in the battery compartment as illustrated.
3. Replace back cover on remote control.

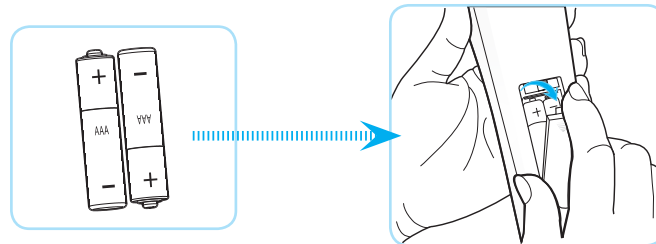

Note: Replace only with the same or equivalent type batteries.

CAUTION

Improper use of batteries can result in chemical leakage or explosion. Be sure to follow the instructions below.

- Do not mix batteries of different types. Different types of batteries have different characteristics.
- Do not mix old and new batteries. Mixing old and new batteries can shorten the life of new batteries or cause chemical leakage in old batteries.
- Remove batteries as soon as they are depleted. Chemicals that leak from batteries that come in contact with skin can cause a rash. If you find any chemical leakage, wipe thoroughly with a cloth.
- The batteries supplied with this product may have a shorter life expectancy due to storage conditions.
- If you will not be using the remote control for an extended period of time, remove the batteries.
- When you dispose of the batteries, you must obey the law in the relative area or country.

Effective range

Infra-Red (IR) remote control sensor is located on the front side and rear side of the projector. Ensure to hold the remote control at an angle within 30 degrees perpendicular to the projector's IR remote control sensor to function correctly. The distance between the remote control and the sensor should not be longer than 7 meters (~ 23 feet).

- Make sure that there are no obstacles between the remote control and the IR sensor on the projector that might obstruct the infra-red beam.
- Make sure the IR transmitter of the remote control is not being shined by sunlight or fluorescent lamps directly.
- Please keep the remote controller away from fluorescent lamps for over 2 m or the remote controller might become malfunction.
- If the remote control is close to Inverter-Type fluorescent lamps, it might become ineffective from time to time.
- If the remote control and the projector are within a very short distance, the remote control might become ineffective.
- When you aim at the screen, the effective distance is less than 5 m from the remote control to the screen and reflecting the IR beams back to the projector. However, the effective range might change according to screens.

SETUP AND INSTALLATION

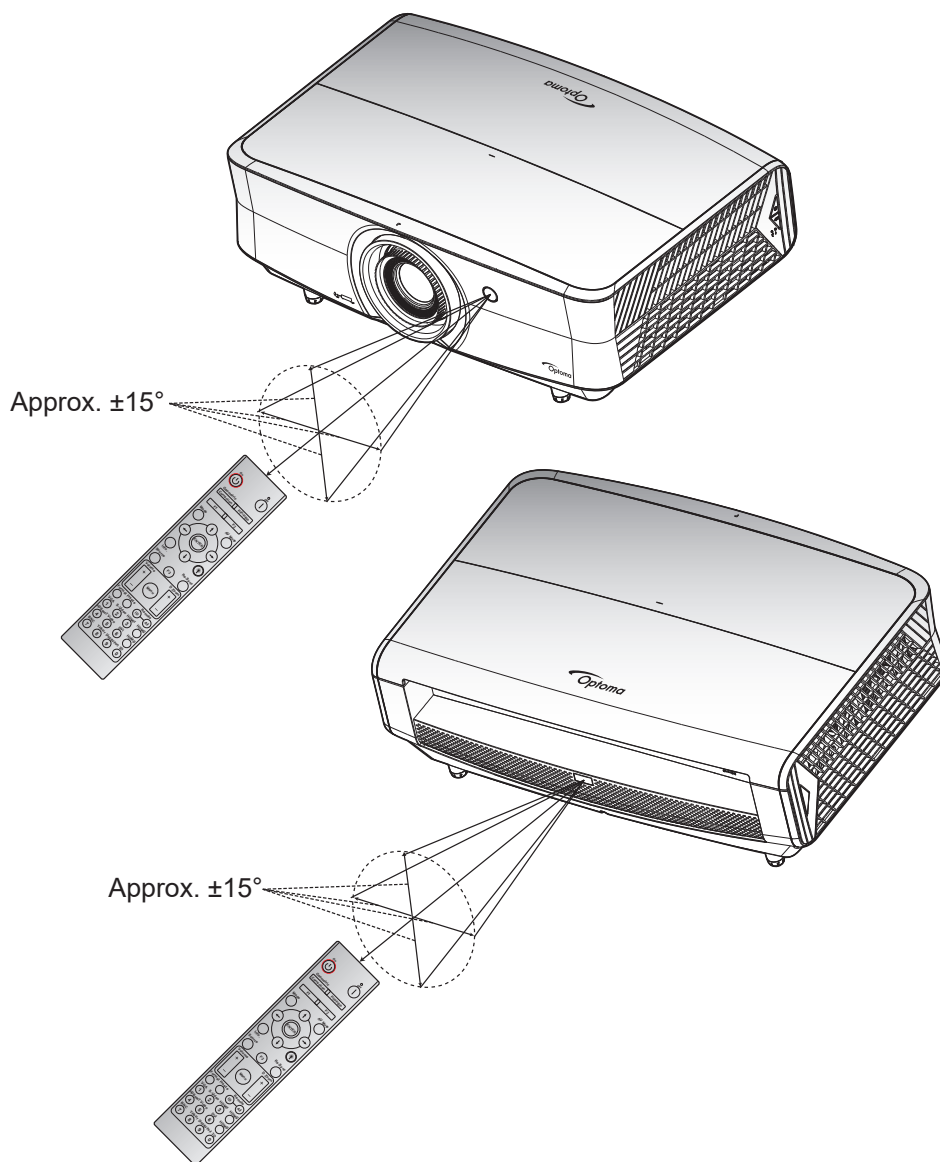

USING THE PROJECTOR

Powering on / off the projector

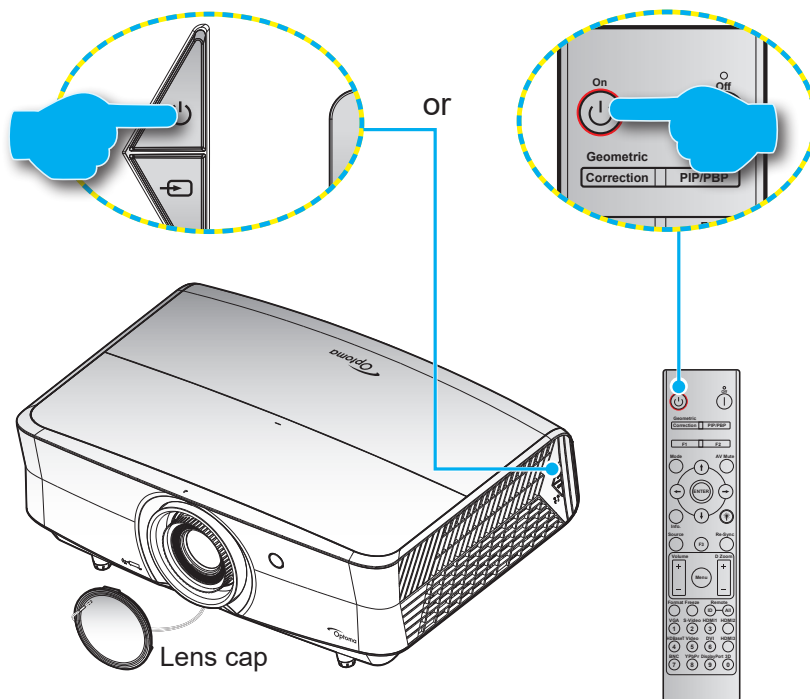



Powering on





1. Remove the lens cap.
2. Securely connect the power lead and signal/source cable. When connected, the Power LED will turn red.
3. Turn on the projector by pressing the  button on the projector keypad or remote control.
4. A start up screen will display in approximately 10 seconds and the Power LED will be flashing blue.

Note: The first time the projector is turned on, you will be prompted to select the preferred language, projection orientation, and other settings.

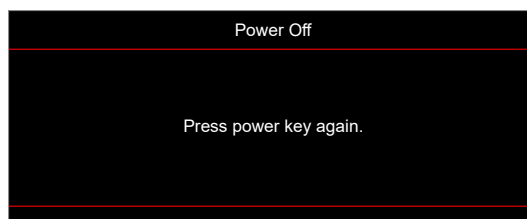
Powering off

1. Turn off the projector by pressing the  button on the projector keypad or the  button on the remote control.
2. The following message will be displayed:



3. Press the  or  button again to confirm, otherwise the message will disappear after 15 seconds. When you press the  or  button for the second time, the projector will shut down.
4. The cooling fans will continue to operate for about 10 seconds for the cooling cycle and the Power LED will flash blue. When the Power turns solid red, this indicates the projector has entered standby mode. If you wish to turn the projector back on, you must wait until the cooling cycle has finished and the projector has entered standby mode. When the projector is in standby mode, simply press the  button again to turn on the projector.
5. Disconnect the power lead from the electrical outlet and the projector.

Note: It is not recommended that the projector is turned on immediately, right after a power off procedure.

USING THE PROJECTOR

Selecting an input source

Turn on the connected source that you want to display on the screen, such as computer, notebook, video player, etc. The projector will automatically detect the source. If multiple sources are connected, push the source button on the projector keypad or the remote control to select the desired input.

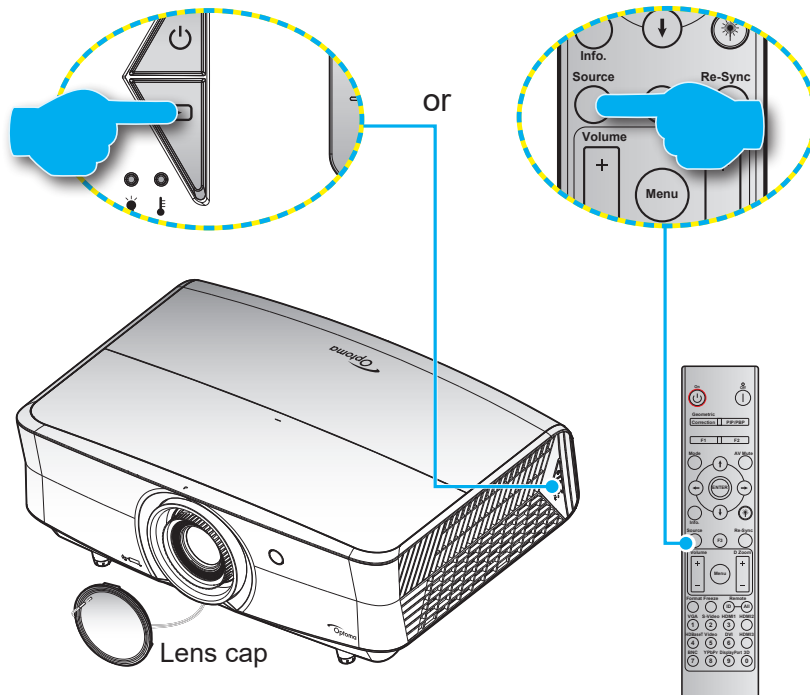

USING THE PROJECTOR

Menu navigation and features

The projector has multilingual on-screen display menus that allow you to make image adjustments and change a variety of settings. The projector will automatically detect the source.

1. To open the OSD menu, press the  button on the projector keypad or the **Menu** button on the remote control.
2. When OSD is displayed, use **▲▼** keys to select any item in the main menu. While making a selection on a particular page, press the **←** button on the projector keypad or the **Enter** button on the remote control to enter sub menu.
3. Use **◀▶** keys to select the desired item in the sub menu and then press the **←** or **Enter** button to view further settings. Adjust the settings by using **◀▶** keys.
4. Select the next item to be adjusted in the sub menu and adjust as described above.
5. Press press the **←** or **Enter** button to confirm, and the screen will return to the main menu.
6. To exit, press the  or **Menu** button again. The OSD menu will close and the projector will automatically save the new settings.

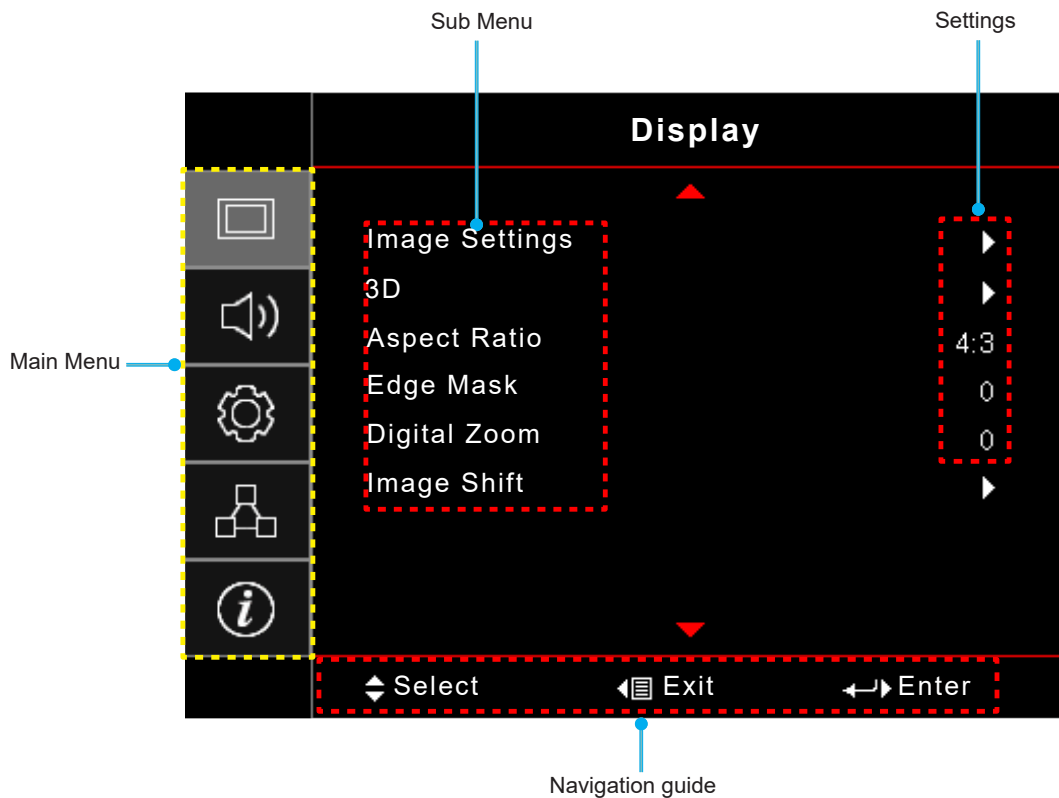

USING THE PROJECTOR

OSD Menu tree

| Main Menu | Sub Menu | Sub Menu 2 | Sub Menu 3 | Sub Menu 4 | Values | | |
|-----------|----------------|--------------|---------------|------------------|--|---------------|--------------------|
| Display | Image Settings | Display Mode | | | Presentation [Default] | | |
| | | | | | Bright | | |
| | | | | | HDR | | |
| | | | | | HLG <i>Note: HLG functions vary by model.</i> | | |
| | | | | | HDR SIM. | | |
| | | | | | Cinema | | |
| | | | | | Game | | |
| | | | | | sRGB | | |
| | | | | | DICOM SIM. | | |
| | | | | | HDR2 | | |
| | | | | 3D | | | |
| | | | Wall Color | | | Off [Default] | |
| | | | | | | Blackboard | |
| | | | | | | Light Yellow | |
| | | | | | | Light Green | |
| | | | | | | Light Blue | |
| | | | | | | Pink | |
| | | | Dynamic Range | HDR/HLG | | | Off |
| | | | | | | | Auto [Default] |
| | | | | HDR Picture Mode | | | Bright |
| | | | | | | | Standard [Default] |
| | | | | | | | Film |
| | | | | HLG Picture Mode | | | Detail |
| | | | | | | | Bright |
| | | | | | | | Standard [Default] |
| | | | | | | | Film |
| | | | | | | Detail | |
| | | | | Brightness | | | -50 ~ 50 |
| | | | | Contrast | | | -50 ~ 50 |
| | | | | Sharpness | | | 1 ~ 15 |
| | | | | Color | | | -50 ~ 50 |
| | | | | Tint | | | -50 ~ 50 |

USING THE PROJECTOR

| Main Menu | Sub Menu | Sub Menu 2 | Sub Menu 3 | Sub Menu 4 | Values | |
|---------------|----------------|----------------|------------------|-------------------|--------------|-----------------------|
| Display | Image Settings | Gamma | Film | | | |
| | | | Video | | | |
| | | | Graphics | | | |
| | | | Standard(2.2) | | | |
| | | | 1.8 | | | |
| | | | 2.0 | | | |
| | | | 2.4 | | | |
| | | | 2.6 | | | |
| | | | 3D | | | |
| | | | Blackboard | | | |
| | | | DICOM SIM. | | | |
| | | Color Settings | BrilliantColor™ | | | 1 ~ 10 |
| | | | | Color Temperature | | Warm |
| | | | | | Standard | |
| | | | | | Cool | |
| | | | | | Cold | |
| | | | Color Gamut | | Native | |
| | | | | | HDTV | |
| | | | | | Presentation | |
| | | | | | Cinema | |
| | | | | | Game | |
| | | | CMS | Color | | R [Default] |
| | | | | | | G |
| | | | | | | B |
| | | | | | | C |
| | | | | | | Y |
| | | | | | | M |
| | | | | | | W |
| | | | | | | |
| | | | | x offset | | -50 ~ 50 [Default: 0] |
| | | | | y offset | | -50 ~ 50 [Default: 0] |
| | | | | Brightness | | -50 ~ 50 [Default: 0] |
| | | | | Reset | | Cancel [Default] |
| | Yes | | | | | |
| Exit | | | | | | |
| RGB Gain/Bias | Red Gain | | | -50 ~ 50 | | |
| | Green Gain | | | -50 ~ 50 | | |
| | Blue Gain | | | -50 ~ 50 | | |
| | Red Bias | | 0 ~ 100 | | | |
| | Green Bias | | 0 ~ 100 | | | |
| | Blue Bias | | 0 ~ 100 | | | |
| | Reset | | Cancel [Default] | | | |
| | | | Yes | | | |
| Exit | | | | | | |

USING THE PROJECTOR

| Main Menu | Sub Menu | Sub Menu 2 | Sub Menu 3 | Sub Menu 4 | Values |
|-----------|----------------|-----------------|-----------------|--|---|
| Display | Image Settings | Color Settings | Color Space | Color Space [Not HDMI Input] | Auto [Default] |
| | | | | | RGB |
| | | | | | YUV |
| | | | | Color Space [HDMI Input] | Auto [Default] |
| | | | | | RGB(0~255) |
| | | | | | RGB(16~235) |
| | | | | | YUV |
| | | | | Signal | Automatic |
| | | | On [Default] | | |
| | | Frequency | | | -50 ~ 50 (depends on signal) [Default: 0] |
| | | Phase | | | 0~31 (depends on signal) [Default: 0] |
| | | H. Position | | | -50 ~ 50 (depends on signal) [Default: 0] |
| | | V. Position | | -50 ~ 50 (depends on signal) [Default: 0] | |
| | | UltraDetail | | | Off |
| | | | | | 1 |
| | | | | | 2 |
| | | | | | 3 |
| | | Brightness Mode | | | DynamicBlack 1 |
| | | | | | DynamicBlack 2 |
| | | | | | DynamicBlack 3 |
| | | | | | Power (Power = 100%/ 95%/ 90%/ 85%/ 80%/ 75%/ 70%/ 65%/ 60%/ 55%/ 50%) |
| | | PureEngine | PureContrast | | Off |
| | | | | | On |
| | | | PureColor | | Off |
| | | | | | 1 |
| | | | | | 2 |
| | | | | | 3 |
| | | | | | 4 |
| | | | PureMotion | | 5 |
| | | | | | Off |
| | | | | | 1 |
| | | | PureMotion Demo | | 2 |
| | 3 | | | | |
| | Off [Default] | | | | |
| | | | H Split | | |
| | | | V Split | | |
| Reset | | | | | |





USING THE PROJECTOR

| Main Menu | Sub Menu | Sub Menu 2 | Sub Menu 3 | Sub Menu 4 | Values | |
|-------------|---|---------------------------|------------|------------------|---|-------------------|
| Display | 3D | 3D Mode | | | Off [Default] | |
| | | | | | On | |
| | | 3D Sync Invert | | | On | |
| | | | | | Off [Default] | |
| | | 3D Format | | | Auto [Default] | |
| | | | | | SBS | |
| | | | | | Top and Bottom | |
| | | | | Frame Sequential | | |
| | Aspect Ratio | | | | 4:3 | |
| | | | | | 16:9 | |
| | | | | | LBX | |
| | | | | | Superwide | |
| | | | | | Native | |
| | | | | | Auto | |
| | Edge Mask | | | | 0 ~ 10 [Default: 0] | |
| | Digital Zoom | | | | -5 ~ 25 [Default: 0] | |
| Image Shift | H  | | | | -100 ~ 100 [Default: 0] | |
| | V  | | | | -100 ~ 100 [Default: 0] | |
| Audio | Internal Speaker | | | | Auto [Default] | |
| | | | | | Off | |
| | | | | | On | |
| | Mute | | | | | Off [Default] |
| | | | | | | On |
| | Volume | | | | 0 ~ 10 [Default: 5] | |
| | Audio Input | HDMI | | | | Default [Default] |
| | | | | | | Audio In |
| HDMI/MHL | | | | | Default [Default] | |
| | | | | | Audio In | |
| Audio Out | | | | | Off [Default] | |
| | | | | | On | |
| Setup | Projection | | | | Front  [Default] | |
| | | | | | Rear  | |
| | | | | | Ceiling-Top  | |
| | | | | | Rear-Top  | |
| | Filter Settings | Filter Usage Hours | | | | (read only) |
| | | Optional Filter Installed | | | | Yes |
| | | | | | No | |

USING THE PROJECTOR

| Main Menu | Sub Menu | Sub Menu 2 | Sub Menu 3 | Sub Menu 4 | Values | | |
|-----------|-------------------------------------|-----------------------|------------|------------|--|--------------|--------------|
| Setup | Filter Settings | Filter Reminder | | | Off | | |
| | | | | | 300hr | | |
| | | | | | 500hr [Default] | | |
| | | | | | 800hr | | |
| | | | | | 1000hr | | |
| | | Filter Reset | | | Cancel [Default] | | |
| | | | | Yes | | | |
| | Power Settings | Direct Power On | | | Off [Default] | | |
| | | | | | On | | |
| | | Auto Power Off (min.) | | | 0 ~ 180 (5 min increments) [Default: 0] | | |
| | | Sleep Timer (min.) | | | 0 ~ 990 (30 min increments) [Default: 0] | | |
| | | | Always On | | | No [Default] | |
| | | | | | | Yes | |
| | Power Mode (Standby) | | | | Active | | |
| | | | | | Eco [Default] | | |
| | Security | Security | | | Off | | |
| | | | | | On | | |
| | | Security Timer | Month | | | | |
| | | | Day | | | | |
| | | | Hour | | | | |
| | | Change Password | | | | | |
| | Test Pattern | | | | | Green Grid | |
| | | | | | | Magenta Grid | |
| | | | | | | White Grid | |
| | | | | | | White | |
| | | | | | | Off | |
| | Remote Settings [depends on remote] | IR Function | | | | On | |
| | | | | | | Front | |
| | | | | | | Back | |
| | | | | | | Off | |
| | | F1 | | | | | Test Pattern |
| | | | | | | | Brightness |
| | | | | | | Contrast | |
| | | | | | | Sleep Timer | |
| | | | | | | Color Temp | |
| | | | | | | Gamma | |
| | | | | | | Projection | |
| | | | | | | MHL | |
| | | | | | | | |

USING THE PROJECTOR

| Main Menu | Sub Menu | Sub Menu 2 | Sub Menu 3 | Sub Menu 4 | Values | | |
|-----------|--|--------------|---------------|---------------|--|---|--|
| Setup | Remote Settings [depends on remote] | F2 | | | Test Pattern | | |
| | | | | | Brightness | | |
| | | | | | Contrast | | |
| | | | | | Sleep Timer | | |
| | | | | | Color Temp | | |
| | | | | | Gamma | | |
| | | | | | Projection | | |
| | | | F3 | | | MHL | |
| | | | | | | Test Pattern | |
| | | | | | | Brightness | |
| | | | | | | Contrast | |
| | | | | | | Sleep Timer | |
| | | | | | | Color Temp | |
| | | | | | | Gamma | |
| | | | | Projection | | | |
| | | | | MHL | | | |
| | | Projector ID | | | | 00 ~ 99 | |
| | | 12V Trigger | | | | On | |
| | | | | | | Off | |
| | | Options | Language | | | English [Default] | |
| | | | | | | Deutsch | |
| | | | | | | Français | |
| | | | | | | Italiano | |
| | | | | | | Español | |
| | | | | | | Português | |
| | | | | | | 簡体中文 | |
| | | | | | | 日本語 | |
| | | | | | | 한국어 | |
| | | | | | Русский | | |
| | | | Menu Settings | Menu Location | | | Top left  |
| | | | | | | | Top right  |
| | | | | | | | Center  [Default] |
| | | | | | | Bottom left  | |
| | | | | | Bottom right  | | |
| | Menu Settings | Menu Timer | | | Off | | |
| | | | | | 5sec | | |
| | | | | | 10sec [Default] | | |
| | Auto Source | | | | Off [Default] | | |
| | | | | | On | | |
| | Input Source | | | | HDMI1 | | |
| | | | | | HDMI2/MHL | | |
| | | | | | VGA | | |

USING THE PROJECTOR

| Main Menu | Sub Menu | Sub Menu 2 | Sub Menu 3 | Sub Menu 4 | Values |
|-----------|------------------|----------------------|------------|--------------------------------------|---|
| Setup | Options | High Altitude | | | Off [Default] |
| | | | | | On |
| | | Display Mode Lock | | | Off [Default] |
| | | | | | On |
| | | Keypad Lock | | | Off [Default] |
| | | | | | On |
| | | Information Hide | | | Off [Default] |
| | | | | | On |
| | | Logo | | | Default [Default] |
| | | | | | Neutral |
| | Background Color | | | None [Default] | |
| | | | | Blue | |
| | | | Red | | |
| | | | Green | | |
| Reset | Reset OSD | | | Cancel [Default] | |
| | | | | Yes | |
| | Reset to Default | | | Cancel [Default] | |
| | | | | Yes | |
| Network | LAN | Network Status | | | (read only) |
| | | MAC Address | | | (read only) |
| | | DHCP | | | Off [Default] |
| | | | | | On |
| | | IP Address | | | 192.168.0.100 [Default] |
| | | Subnet Mask | | | 255.255.255.0 [Default] |
| | | Gateway | | | 192.168.0.254 [Default] |
| | | DNS | | | 192.168.0.51 [Default] |
| | Reset | | | | |
| | Control | Crestron | | | Off |
| | | | | | On [Default] Note: Port 41794 |
| | | Extron | | | Off |
| | | | | | On [Default] Note: Port 2023 |
| | | PJ Link | | | Off |
| | | | | | On [Default] Note: Port 4352 |
| | | AMX Device Discovery | | | Off |
| | | | | | On [Default] Note: Port 9131 |
| | | Telnet | | | Off |
| | | | | | On [Default] Note: Port 23 |
| | | HTTP | | | Off |
| | | | | On [Default] Note: Port 80 | |

USING THE PROJECTOR

| Main Menu | Sub Menu | Sub Menu 2 | Sub Menu 3 | Sub Menu 4 | Values | |
|-----------|----------------------|------------|------------|------------|--------------------------|--|
| Info | Regulatory | | | | | |
| | Serial Number | | | | | |
| | Source | | | | | |
| | Resolution | | | | 00x00 | |
| | Refresh Rate | | | | 0.00Hz | |
| | Display Mode | | | | | |
| | Power Mode (Standby) | | | | | |
| | Light Source Hours | | | | | |
| | Network Status | | | | | |
| | IP Address | | | | | |
| | Projector ID | | | | 00 ~ 99 | |
| | Color Depth | | | | Note: 12bit 4:2:2 | |
| | Color Format | | | | Note: BT.2020 HDR | |
| | Filter Usage Hours | | | | | |
| | Brightness Mode | | | | | |
| | FW Version | System | | | | |
| | | LAN | | | | |
| MCU | | | | | | |

USING THE PROJECTOR

Display menu

Display image settings menu

Display Mode

There are many factory presets optimized for various types of images.

- **Presentation:** This mode is suitable for showing in front of public in connection to the PC.
- **Bright:** Maximum brightness from PC input.
- **HDR:** Decodes and displays High Dynamic Range (HDR) content for the deepest blacks, brightest whites, and vivid cinematic color using REC.2020 color gamut. This mode will be automatically enabled if HDR is set to ON (and HDR Content is sent to projector – 4K UHD Blu-ray, 1080p/4K UHD HDR Games, 4K UHD Streaming Video). While HDR mode is active, other display modes (Cinema, Reference, etc.) cannot be selected as HDR delivers color that is highly accurate, exceeding the color performance of the other display modes.
- **HLG:** For HDR movies with Hybrid Log content.
- **HDR SIM.:** Enhances non-HDR content with simulated High Dynamic Range (HDR). Choose this mode to enhance gamma, contrast, and color saturation for non-HDR content (720p and 1080p Broadcast/Cable TV, 1080p Blu-ray, non-HDR Games, etc). This mode can ONLY be used with non-HDR content.
- **Cinema:** Provides the best colors for watching movies.
- **Game:** Select this mode to increase the brightness and response time level for enjoying video games.
- **sRGB:** Standardized accurate color.
- **DICOM SIM.:** This mode can project a monochrome medical image such as an X ray radiography, MRI, etc.
- **HDR2:** This mode produces less bright image but adds more details to the projected image. Suitable for rooms with some ambient light.
- **3D:** To experience the 3D effect, you need to have 3D glasses, make sure your PC/portable device has a 120 Hz signal output quad buffered graphics card and have a 3D Player installed.

Wall Color

Use this function to obtain an optimized screen image according to the wall color. Select between off, blackboard, light yellow, light green, light blue, pink, and gray.

Dynamic Range

Configure the High Dynamic Range (HDR) setting and its effect when displaying video from 4K Blu-ray players and streaming devices.

Note: *HDMI1 and VGA do not support Dynamic Range.*

➤ HDR/HLG

- **Off:** Turn off HDR or HLG processing. When set to Off, the projector will NOT decode HDR or HLG content.
- **Auto:** Auto detect HDR or HLG signal.

➤ HDR Picture Mode

- **Bright:** Choose this mode for brighter more saturated colors.
- **Standard:** Choose this mode for natural looking colors with a balance of warm and cool tones.
- **Film:** Choose this mode for improved detail and image sharpness.
- **Detail:** The signal comes from OETF conversion to achieve the best color matching.

USING THE PROJECTOR

► HLG Picture Mode

- **Bright:** Choose this mode for brighter more saturated colors.
- **Standard:** Choose this mode for natural looking colors with a balance of warm and cool tones.
- **Film:** Choose this mode for improved detail and image sharpness.
- **Detail:** The signal comes from OETF conversion to achieve the best color matching.

Brightness

Adjust the brightness of the image.

Contrast

The contrast controls the degree of difference between the lightest and darkest parts of the picture.

Sharpness

Adjust the sharpness of the image.

Color

Adjust a video image from black and white to fully saturated color.

Tint

Adjust the color balance of red and green.

Gamma

Set up gamma curve type. After the initial setup and fine tuning is completed, utilize the Gamma Adjustment steps to optimize your image output.

- **Film:** For home theater.
- **Video:** For video or TV source.
- **Graphics:** For PC / Photo source.
- **Standard(2.2):** For standardized setting.
- **1.8 / 2.0 / 2.4 / 2.6:** For specific PC / Photo source.
- **3D:** To experience the 3D effect, you need to have 3D glasses. Make sure your PC/portable device has a 120 Hz signal output quad buffered graphics card and a 3D Player installed.
- **Blackboard:** This mode should be selected to achieve optimum color settings when projecting onto a blackboard (green).
- **DICOM SIM.:** This mode can project a monochrome medical image such as an X ray radiography, MRI, etc.

Note:

- *These options are only available if the 3D mode function is disabled, the **Wall Color** setting is not set to **Blackboard**, and the **Display Mode** setting is not set to **DICOM SIM.** or **HDR.***
- *If the **Display Mode** setting is set to **HDR**, user can only select **HDR** for **Gamma** setting.*
- *In 3D mode, user can only select **3D** for **Gamma** setting.*
- *If the **Wall Color** setting is set to **Blackboard**, user can only select **Blackboard** for **Gamma** setting.*
- *If the **Display Mode** setting is set to **DICOM SIM.**, user can only select **DICOM SIM.** for **Gamma** setting.*

Color Settings

Configure the color settings.

- **BrilliantColor™:** This adjustable item utilizes a new color-processing algorithm and enhancements to enable higher brightness while providing true, more vibrant colors in picture.
- **Color Temperature:** Select a color temperature from Warm, Standard, Cool, or Cold.

USING THE PROJECTOR

- **Color Gamut:** Select this menu to optimize the color gamut color range for Native, HDTV, Presentation, Cinema, and Game.
- **CMS:** Select the following options:
 - Color: Select one of the colors (R/G/B/C/Y/M/W) to adjust its x/y offset and brightness.
 - x Offset: Adjust the x offset value of selected color.
 - y Offset: Adjust the y offset value of selected color.
 - Brightness: Adjust the brightness value of selected color.
 - Reset: Choose “Yes” to return the factory default settings for color adjustments.
 - Exit: Exit the “CMS” menu.
- **RGB Gain/Bias:** This settings allows to configure the brightness (gain) and contrast (bias) of an image.
 - Reset: Choose “Yes” to return the factory default settings for RGB gain/bias.
 - Exit: Exit the “RGB Gain/Bias” menu.
- **Color Space (non-HDMI input only):** Select an appropriate color matrix type from the following: AUTO, RGB, or YUV.
- **Color Space (HDMI input only):** select an appropriate color matrix type from the following: Auto, RGB(0-255), RGB(16-235), and YUV.

Signal

Adjust the signal options.

- **Automatic:** Configure automatically the signal (the frequency and phase items are grayed out). If automatic is disabled, the frequency and phase items will appear for tuning and saving the settings.
- **Frequency:** Change the display data frequency to match the frequency of your computer’s graphic card. Use this function only if the image appears to flicker vertically.
- **Phase:** Synchronize the signal timing of the display with the graphic card. If the image appears to be unstable or flickers, use this function to correct it.
- **H. Position:** Adjust the horizontal positioning of the image.
- **V. Position:** Adjust the vertical positioning of the image.

Note: *This menu is only available if the input source is RGB/Component.*

Ultra Detail

Adjust the edges of the projected image in order to provide more perceived details.

Brightness Mode

Adjust the brightness mode settings.

- **DynamicBlack1/ DynamicBlack2/ DynamicBlack3:** Use to automatically adjust the picture brightness in order to give optimum contrast performance.
- **Power:** Choose the power percentage for brightness mode.

USING THE PROJECTOR

PureEngine

Adjust the PureEngine parameters.

- **PureContrast:** Use to automatically optimize the brightness of the display during dark / light movie scenes to be shown in incredible detail.
- **PureColor:** Use to significantly increase the image's vividness.
- **PureMotion:** Use to preserve a natural motion of the displayed image.
- **PureMotion Demo:** This feature enables you to see the difference in the image quality between the raw unprocessed image and the image processed as processed by the PureMotion. Use this mode to check the adjustments that you make to the PureMotion settings.

Note: *This menu is only available for certain models.*

Reset

Return the factory default settings for color settings.

USING THE PROJECTOR

Display 3D menu

Note:

- This projector is a 3D ready projector with DLP-Link 3D solution.
- Please make sure your 3D glasses are use for DLP-Link 3D before enjoy your video.
- This projector supports frame sequential (page-flip) 3D via HDMI1/HDMI2/VGA ports.
- To enable 3D mode, the input frame rate should be set to 120Hz only, lower or higher frame rate is not supported.
- To reach the best performance, resolution 1920x1080 is recommended, please be noted that 4K (3840x2160) resolution is not supported in 3D mode.

3D Mode

Use this option to enable/disable the 3D function.

Note: If the 2D and 3D sources enter PJ at the same time, if the ghosting image appears in the 2D source, make sure to manually turn off the 3D function.

3D Sync Invert

Use this option to enable/disable the 3D sync invert function.

3D Format

Use this option to select the appropriate 3D format content.

- **Auto:** When a 3D identification signal is detected, the 3D format is selected automatically.
- **SBS:** Display 3D signal in “Side-by-Side” format.
- **Top and Bottom:** Display 3D signal in “Top and Bottom” format.
- **Frame Sequential:** Display 3D signal in “Frame Sequential” format.
- **Frame Packing:** Display 3D signal in “Frame Packing” format.

Display aspect ratio menu

Aspect Ratio

Select the aspect ratio of the displayed image between the following options:

- **4:3:** This format is for 4:3 input sources.
- **16:9:** This format is for 16:9 input sources, like HDTV and DVD enhanced for Wide screen TV.
- **LBX:** This format is for non-16x9, letterbox source and if you use external 16x9 lens to display 2.35:1 aspect ratio in full resolution.
- **Superwide:** Use this special 2.0:1 aspect ratio to display both 16:9 and 2.35:1 aspect ratio movies without black bars at the top and bottom of the screen.
- **Native:** This format displays the original image without any scaling.
- **Auto:** Automatically selects the appropriate display format.

USING THE PROJECTOR

Note:

- Detailed informations about LBX mode:
 - Some Letter-Box Format DVDs are not enhanced for 16x9 TVs. In this situation, the image will not look right when displaying image in 16:9 mode. In this situation, please try to use the 4:3 mode to view the DVD. If the content is not 4:3, there will be black bars around the image in 16:9 display. For this type of content, you can use LBX mode to fill the image on the 16:9 display.
 - If you use an external anamorphic lens, this LBX mode also allows you to watch a 2.35:1 content (include Anamorphic DVD and HDTV film source) that supports anamorphic wide is enhanced for 16x9 Display in a wide 2.35:1 image. In this case, there are no black bars. Light source power and vertical resolution are fully utilized.
- To use the superwide format, do the following:
 - a) Set the screen aspect ratio to 2.0:1.
 - b) Select “Superwide” format.
 - c) Align the projector image correctly on the screen.

4D UHD scaling table:

| 16:9 screen | 480i/p | 576i/p | 720p | 1080i/p | 2160p |
|-------------|--|--------|------|---------|-------|
| 4x3 | Scale to 2880 x 2160. | | | | |
| 16x9 | Scale to 3840 x 2160. | | | | |
| LBX | Scale to 3840 x 1620, then get the central 3840 x 2160 image to display. | | | | |
| Native mode | - 1:1 mapping centered. - No scaling will be made; the image is displayed with the resolution based on input source. | | | | |
| Auto | - If source is 4:3, the screen type will be scaled to 2880 x 2160. - If source is 16:9, the screen type will be scaled to 3840 x 2160. - If source is 15:9, the screen type will be scaled to 3600 x 2160. - If source is 16:10, the screen type will be scaled to 3456 x 2160. | | | | |

4D UHD auto mapping rule:

| Auto | Input resolution | | Auto/Scale | |
|-------------|------------------|--------------|------------|------|
| | H-resolution | V-resolution | 3840 | 2160 |
| 4:3 | 640 | 480 | 2880 | 2160 |
| | 800 | 600 | 2880 | 2160 |
| | 1024 | 768 | 2880 | 2160 |
| | 1280 | 1024 | 2880 | 2160 |
| | 1400 | 1050 | 2880 | 2160 |
| | 1600 | 1200 | 2880 | 2160 |
| Wide Laptop | 1280 | 720 | 3840 | 2160 |
| | 1280 | 768 | 3600 | 2160 |
| | 1280 | 800 | 3456 | 2160 |
| SDTV | 720 | 576 | 2700 | 2160 |
| | 720 | 480 | 3240 | 2160 |
| HDTV | 1280 | 720 | 3840 | 2160 |
| | 1920 | 1080 | 3840 | 2160 |

USING THE PROJECTOR

Display edge mask menu

Edge Mask

Use this function to remove the video encoding noise on the edge of video source.

Display digital zoom menu

Digital Zoom

Use to reduce or magnify an image on the projection screen.

Display image shift menu

Image Shift

Adjust the projected image position horizontally (H) or vertically (V).

USING THE PROJECTOR

Audio menu

Audio internal speaker menu

Internal Speaker

Use this option to temporarily turn off the sound.

- **Auto:** Choose “Auto” to automatically turn off the internal speaker when an external speaker is connected to the projector
- **On:** Choose “On” to turn on the internal speaker.
- **Off:** Choose “Off” to turn off the internal speaker.

Audio mute menu

Mute

Use this option to temporarily turn off the sound.

- **On:** Choose “On” to turn mute on.
- **Off:** Choose “Off” to turn mute off.

Note: “Mute” function affects both internal and external speaker volume.

Audio volume menu

Volume

Adjust the volume level.

Audio audio input menu

Audio Input

Select the audio input port for the video sources as follows:

- **HDMI:** Default or Audio In.
- **HDMI/MHL:** Default or Audio In.

Audio audio out menu

Audio Out

Enable or disable the audio out function.

USING THE PROJECTOR

Setup menu

Setup projection menu

Projection

Select the preferred projection between front, rear, ceiling-top, and rear-top.

Setup filter settings menu

Filter Usage Hours

Display the filter time.

Optional Filter Installed

Set the warning message setting.

- **Yes:** Display warning message after 500 hours of use.

Note: “Filter Usage Hours / Filter Reminder / Filter Reset” will only appear when “Optional Filter Installed” is “Yes”.

- **No:** Turn off warning message.

Filter Reminder

Choose this function to show or hide the warning message when the changing filter message is displayed. The available options include Off, 300hr, 500hr, 800hr, and 1000hr.

Filter Reset

Reset the dust filter counter after replacing or cleaning the dust filter.

Setup power settings menu

Direct Power On

Choose “On” to activate Direct Power mode. The projector will automatically power on when AC power is supplied, without pressing the “Power” key on the projector keypad or on the remote control.

Auto Power Off (min.)

Sets the countdown timer interval. The countdown timer will start, when there is no signal being sent to the projector. The projector will automatically power off when the countdown has finished (in minutes).

Sleep Timer (min.)

Configure the sleep timer.

- **Sleep Timer (min.):** Sets the countdown timer interval. The countdown timer will start, with or without a signal being sent to the projector. The projector will automatically power off when the countdown has finished (in minutes).

Note: *The Sleep Timer is reset every time when the projector is powered off.*

- **Always On:** Check to set the sleep timer always on.

Power Mode (Standby)

Set the power mode setting.

- **Active:** Choose “Active” to return to normal standby.
- **Eco:** Choose “Eco.” to save power dissipation further < 0.5W.

USING THE PROJECTOR

Setup security menu

Security

Enable this function to prompt for a password before using the projector.

- **On:** Choose “On” to use security verification when the turning on the projector.
- **Off:** Choose “Off” to be able to switch on the projector without password verification.

Security Timer

Can be select the time (Month/Day/Hour) function to set the number of hours the projector can be used. Once this time has elapsed you will be requested to enter your password again.

Change Password

Use to set or modify the password that is prompted when turning the projector on.

Setup test pattern menu

Test Pattern

Select the test pattern from green grid, magenta grid, white grid, white, or disable this function (off).

Setup remote settings menu

IR Function

Set the IR function setting.

- **On:** Choose “On”, the projector can be operated by the remote control from the top and front IR receivers.
- **Front:** Choose “Front”, the projector can be operated by the remote control from the front IR receiver.
- **Back:** Choose “Back”, the projector can be operated by the remote control from the rear IR receiver.
- **Off:** Choose “Off”, the projector can't be operated by the remote control. By selecting “Off”, you will be able to use the Keypad keys.

F1/F2/F3

Assign the default function for F1, F2, or F3 between Test Pattern, Brightness, Contrast, Sleep Timer, Color Temp, Gamma, Projection, or MHL.

Setup projector ID menu

Projector ID

ID definition can be set up by menu (range 0-99), and allow user control an individual projector by using RS232 command.

USING THE PROJECTOR

Setup 12V trigger menu

12V Trigger

Use this function to enable or disable the trigger.

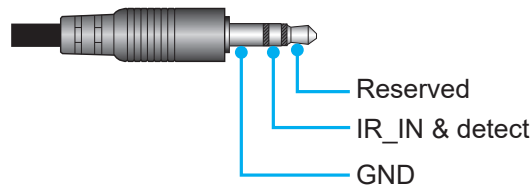

- **Off:** Choose “Off” to disable the trigger.
- **On:** Choose “On” to enable the trigger.

Setup options menu

Language

Select the multilingual OSD menu between English, German, French, Italian, Spanish, Portuguese, simplified Chinese, Japanese, Korean, and Russian.

Menu Settings

Set the menu location on the screen and configure menu timer settings.

- **Menu Location:** Select the menu location on the display screen.
- **Menu Timer:** Set the duration where the OSD menu stays visible on the screen.

Auto Source

Choose this option to let the projector automatically find an available input source.

Input Source

Select the input source between HDMI1, HDMI2/MHL, and VGA.

High Altitude

When “On” is selected, the fans will spin faster. This feature is useful in high altitude areas where the air is thin.

Display Mode Lock

Choose “On” or “Off” to lock or unlock adjusting display mode settings.

Keypad Lock

When the keypad lock function is “On”, the Keypad will be locked. However, the projector can be operated by the remote control. By selecting “Off”, you will be able to reuse the Keypad.

Information Hide

Enable this function to hide the information message.

- **Off:** Choose “Off” to show the “searching” message.
- **On:** Choose “On” to hide the info message.

Logo

Use this function to set the desired startup screen. If changes are made, they will take effect the next time the projector is powered on.

- **Default:** The default startup screen.
- **Neutral:** Logo is not displayed on startup screen.

USING THE PROJECTOR

Background Color

Use this function to display a blue, red, green, or gray screen when no signal is available.

Note: *If the background color is set to “None”, then the background color is black.*

Setup reset OSD menu

Reset OSD

Return the factory default settings for OSD menu settings.

Reset to Default

Return the factory default settings for all settings.

Network menu

Network LAN menu

Network Status

Display the network connection status (read-only).

MAC Address

Display the MAC address (read-only).

DHCP

Use this option to enable or disable the DHCP function.

- **Off:** To assign IP, subnet mask, gateway, and DNS configuration manually.
- **On:** Projector will obtain an IP address automatically from your network.

Note: *Exiting OSD will automatically apply the entered values.*

IP Address

Display the IP address.

Subnet Mask

Display subnet mask number.

Gateway

Display the default gateway of the network connected to the projector.

DNS

Display the DNS number.

How to use web browser to control your projector

1. Turn “On” the DHCP option on projector to allow a DHCP server to automatically assign an IP address.
2. Open the web browser in your PC and type in the projector’s IP address (“Network > LAN > IP Address”).
3. Enter the user name and password, and click “Login”.
The projector’s configuration web interface opens.

Note:

- *The default user name and password is “admin”.*
- *The steps in this section is based on Windows 7 operating system.*

USING THE PROJECTOR

Making a direct connection from your computer to the projector*

1. Turn “Off” the DHCP option on the projector.
2. Configure the IP address, Subnet Mask, Gateway, and DNS on projector (“Network > LAN”).
3. Open **Network and Sharing Center** page on your PC, and assign the identical network parameters to your PC as set on projector. Click “OK” to save the parameters.

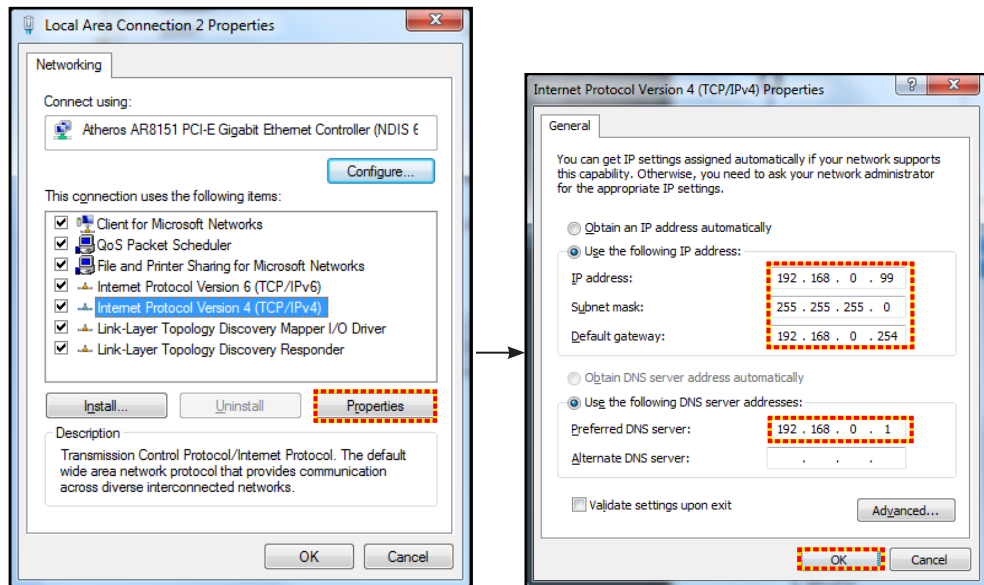

4. Open the web browser on your PC and type in to the URL field the IP address, assigned in step 3. Then press “Enter” key.

Reset

Reset all values for LAN parameters.

Network control menu

Crestron

Use this function to select the network function (port: 41794).

For more information, please visit <http://www.crestron.com> and www.crestron.com/getroomview.

Extron

Use this function to select the network function (port: 2023).

PJ Link

Use this function to select the network function (port: 4352).

AMX Device Discovery

Use this function to select the network function (port: 9131).

Telnet

Use this function to select the network function (port: 23).

HTTP

Use this function to select the network function (port: 80).

USING THE PROJECTOR

Setup network control settings menu

LAN_RJ45 function

For simplicity and ease of operation, the projector provides diverse networking and remote management features. The LAN / RJ45 function of the projector through a network, such as remotely manage: Power On / Off, brightness, and contrast settings. Also, you can view the projector status information, such as: Video- Source, Sound-Mute, etc.

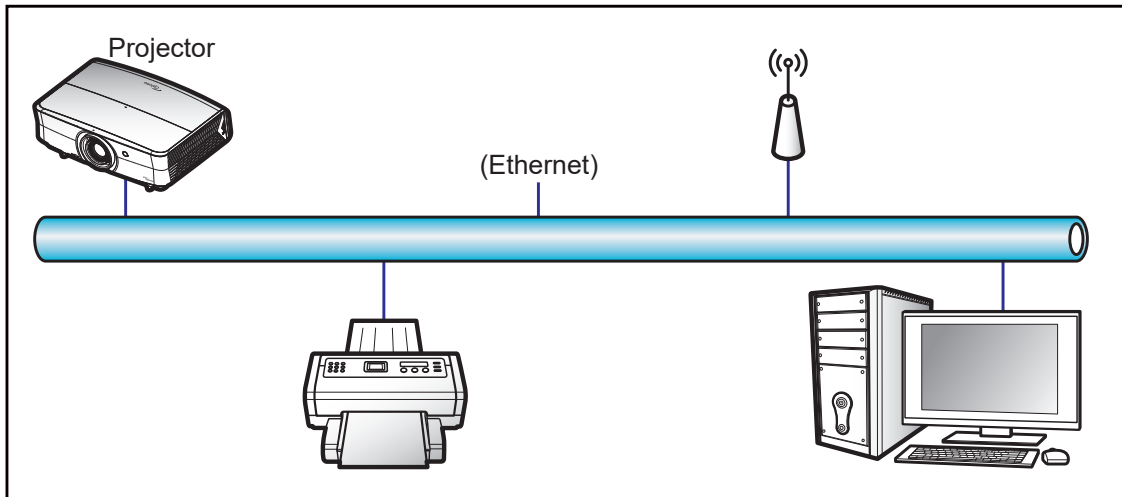

Wired LAN terminal functionalities

This projector can be controlled by using a PC (laptop) or other external device via LAN / RJ45 port and compatible with Crestron / Extron / AMX (Device -Discovery) / PJLink.

- Crestron is a registered trademark of Crestron Electronics, Inc. of the United States.
- Extron is a registered trademark of Extron Electronics, Inc. of the United States.
- AMX is a registered trademark of AMX LLC of the United States.
- PJLink applied for trademark and logo registration in Japan, the United States of America, and other countries by JBMIA.

The projector is supported by the specified commands of the Crestron Electronics controller and related software, for example RoomView®.

<http://www.crestron.com/>

This projector is compliant to support Extron device(s) for reference.

<http://www.extron.com/>

This projector is supported by AMX (Device Discovery).

<http://www.amx.com/>

This projector supports all commands of PJLink Class1 (Version 1.00).

<http://pjlink.jbmia.or.jp/english/>

For more detailed information about the various types of external devices which can be connected to the LAN / RJ45 port and remote control the projector, as well as the supported commands for these external devices, please contact the Support-Service directly.

USING THE PROJECTOR

LAN RJ45

1. Connect an RJ45 cable to RJ45 ports on the projector and the PC (laptop).

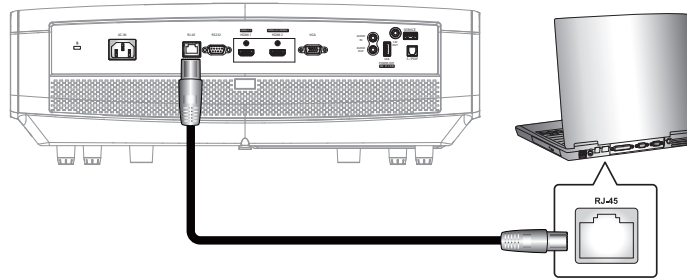

2. On the PC (Laptop), select **Start > Control Panel > Network Connections**.

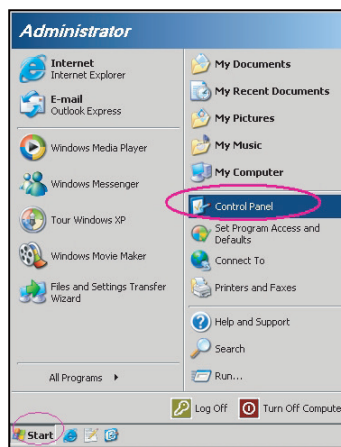

3. Right-click on the **Local Area Connection**, and select **Property**.



4. In the **Properties** window, select the **General tab**, and select **Internet Protocol (TCP / IP)**.

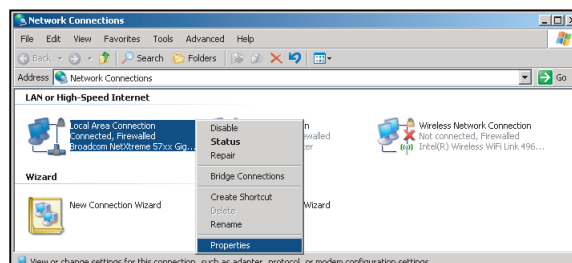

USING THE PROJECTOR

1. Click "Properties".



2. Type in the IP address and Subnet mask, then press "OK".

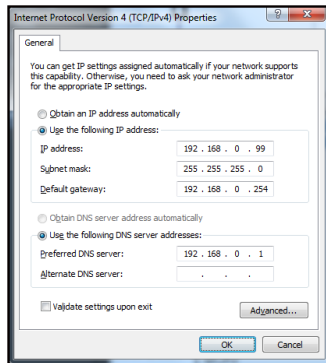

3. Press the "Menu" button on the projector.
4. Open on projector **Network > LAN**.
5. Enter the following connection parameters:
 - DHCP: Off
 - IP Address: 192.168.0.100
 - Subnet Mask: 255.255.255.0
 - Gateway: 192.168.0.254
 - DNS: 192.168.0.51
6. Press "Enter" to confirm settings.
7. Open a web browser, for example Microsoft Internet Explorer with Adobe Flash Player 9.0 or higher installed.
8. In the Address bar, input the projector's IP address: 192.168.0.100.



9. Press "Enter".

USING THE PROJECTOR

The projector is setup for remote management. The LAN / RJ45 function displays as follows:

Information page

Main page

Tool page

Contact IT helpdesk

USING THE PROJECTOR

RS232 by Telnet Function

There is alternative RS232 command control way, in projector so called “RS232 by TELNET” for LAN / RJ45 interface.

Quick Start-Guide for “RS232 by Telnet”

- Check and get the IP address on OSD of the projector.
- Make sure that the PC / laptop can access the web-page of the projector.
- Make sure that “Windows Firewall” setting is set disabled in case of “TELNET” function filtering out by PC / laptop.

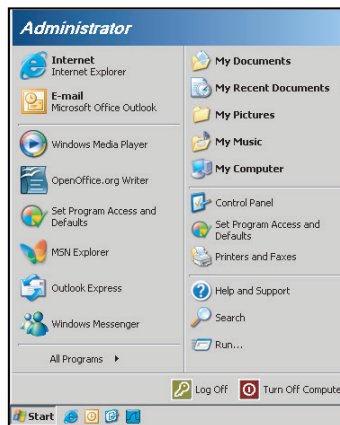

1. Select **Start > All Programs.> Accessories > Command Prompt.**

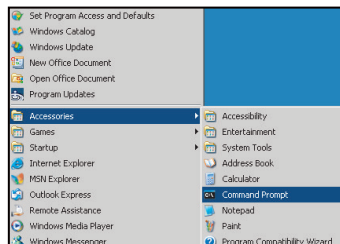

2. Input the command format as follows:
 - telnet ttt.xxx.yyy.zzz 23 (“Enter” key pressed)
 - (ttt.xxx.yyy.zzz: IP-Address of the projector)
3. If Telnet-Connection ready, and user can have RS232 command input, then “Enter” key pressed, the RS232 command will be workable.

Specification for “RS232 by TELNET”:

1. Telnet: TCP.
2. Telnet port: 23 (for more detail, kindly please get contact with the service agent or team).
3. Telnet utility: Windows “TELNET.exe” (console mode).
4. Disconnection for RS232-by-Telnet control normally: Close
5. Windows Telnet utility directly after TELNET connection ready.
 - Limitation 1 for Telnet-Control: there is less than 50 bytes for successive network payload for Telnet-Control application.
 - Limitation 2 for Telnet-Control: there is less than 26 bytes for one complete RS232 command for Telnet-Control.
 - Limitation 3 for Telnet-Control: Minimum delay for next RS232 command must be more than 200 (ms).

USING THE PROJECTOR

Info menu

Info menu

View the projector information as listed below:

- Regulatory
- Serial Number
- Source
- Resolution
- Refresh Rate
- Display Mode
- Power Mode (Standby)
- Light Source Hours
- Network Status
- IP Address
- Projector ID
- Color Depth
- Color Format
- Filter Usage Hours
- Brightness Mode
- FW Version

MAINTENANCE

Installing and cleaning the dust filter

Installing the dust filter

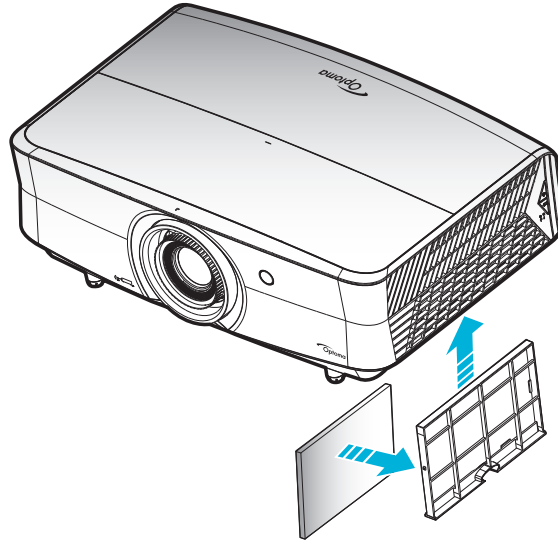

Note: Dust filters are only required/supplied in the selected regions with excessive dust.

Cleaning the dust filter

We recommend you to clean the dust filter every three months. Clean it more often if the projector is used in a dusty environment.

Procedure:

1. Switch off the power to the projector by pressing the "⏻" button on the projector keypad or the "ⓘ" button on the remote control.
2. Disconnect the power cord.
3. Pull the dust filter compartment downwards to remove it out from the bottom of the projector. **1**
4. Carefully remove the air filter. Then clean or replace the dust filter. **2**
5. To install the dust filter, reverse the previous steps.

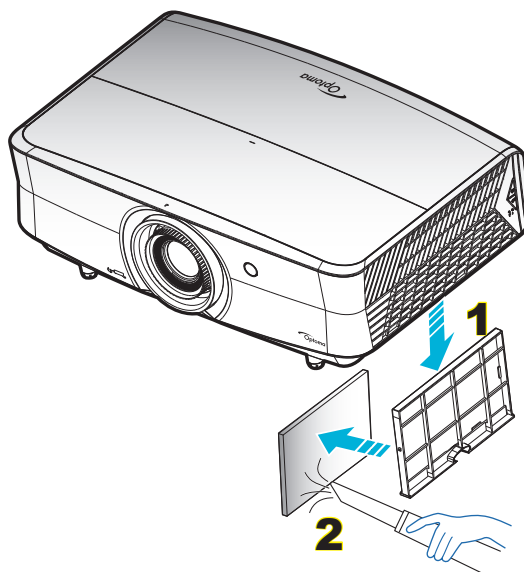

ADDITIONAL INFORMATION

Compatible resolutions

Digital (HDMI 1.4)

Native resolution: 3840 x 2160 @ 30Hz

| B0/Established Timing | B0/Standard Timing | Descriptor Timing | B1/Video Mode | B1/Detail Timing |
|-----------------------|------------------------------|------------------------------|--------------------------|---------------------|
| 720 x 400 @ 70Hz | 1280 x 720 @ 60Hz | 3840 x 2160 @ 30Hz [Default] | 720 x 480i @ 60Hz 16:9 | 1920 x 1080p @ 60Hz |
| 640 x 480 @ 60Hz | 1280 x 800 @ 60Hz | | 720 x 480p @ 60Hz 4:3 | 1366 x 768 @ 60Hz |
| 640 x 480 @ 67Hz | 1280 x 1024 @ 60Hz | | 720 x 480p @ 60Hz 16:9 | 1920 x 1080 @ 120Hz |
| 640 x 480 @ 72Hz | 1920 x 1200 @ 60Hz (reduced) | | 720 x 576i @ 50Hz 16:9 | |
| 640 x 480 @ 75Hz | | | 720 x 576p @ 50Hz 4:3 | |
| 800 x 600 @ 56Hz | 640 x 480 @ 120Hz | | 720 x 576p @ 50Hz 16:9 | |
| 800 x 600 @ 60Hz | 800 x 600 @ 120Hz | | 1280 x 720p @ 60Hz 16:9 | |
| 800 x 600 @ 72Hz | 1024 x 768 @ 120Hz | | 1280 x 720p @ 50Hz 16:9 | |
| 800 x 600 @ 75Hz | 1280 x 800 @ 120Hz | | 1920 x 1080i @ 60Hz 16:9 | |
| 832 x 624 @ 75Hz | | | 1920 x 1080i @ 50Hz 16:9 | |
| 1024 x 768 @ 60Hz | | | 1920 x 1080p @ 60Hz 16:9 | |
| 1024 x 768 @ 70Hz | | | 1920 x 1080p @ 50Hz 16:9 | |
| 1024 x 768 @ 75Hz | | | 1920 x 1080p @ 24Hz 16:9 | |
| 1280 x 1024 @ 75Hz | | | 3840 x 2160 @ 24Hz | |
| 1152 x 870 @ 75Hz | | | 3840 x 2160 @ 25Hz | |
| | | | 3840 x 2160 @ 30Hz | |
| | | | 4096 x 2160 @ 24Hz | |
| | | | 1920 x 1080p @ 120Hz | |

Digital (HDMI 2.0)

Native resolution: 3840 x 2160 @ 60Hz

| B0/Established Timing | B0/Standard Timing | B1/Video Mode | B1/Detail Timing |
|-----------------------|-----------------------------|---------------------------|----------------------|
| 720 x 400 @ 70Hz | 1280 x 720 @ 60Hz | 720 x 480i @ 60Hz 16:9 | 1920 x 1080p @ 120Hz |
| 640 x 480 @ 60Hz | 1280 x 800 @ 60Hz | 720 x 480p @ 60Hz 4:3 | 1366 x 768 @ 60Hz |
| 640 x 480 @ 67Hz | 1280 x 1024 @ 60Hz | 720 x 480p @ 60Hz 16:9 | |
| 640 x 480 @ 72Hz | 1920 x 1200 @ 60Hz(reduced) | 720 x 576i @ 50Hz 16:9 | |
| 640 x 480 @ 75Hz | | 720 x 576p @ 50Hz 4:3 | |
| 800 x 600 @ 56Hz | 640 x 480 @ 120Hz | 720 x 576p @ 50Hz 16:9 | |
| 800 x 600 @ 60Hz | 800 x 600 @ 120Hz | 1280 x 720p @ 60Hz 16:9 | |
| 800 x 600 @ 72Hz | 1024 x 768 @ 120Hz | 1280 x 720p @ 50Hz 16:9 | |
| 800 x 600 @ 75Hz | 1280 x 800 @ 120Hz | 1920 x 1080i @ 60Hz 16:9 | |
| 832 x 624 @ 75Hz | | 1920 x 1080i @ 50Hz 16:9 | |
| 1024 x 768 @ 60Hz | | 1920 x 1080p @ 60Hz 16:9 | |
| 1024 x 768 @ 70Hz | | 1920 x 1080p @ 50Hz 16:9 | |
| 1024 x 768 @ 75Hz | | 1920 x 1080p @ 24Hz 16:9 | |
| 1280 x 1024 @ 75Hz | | 1920 x 1080p @ 120Hz 16:9 | |
| 1152 x 870 @ 75Hz | | 3840 x 2160 @ 24Hz | |
| | | 3840 x 2160 @ 25Hz | |
| | | 3840 x 2160 @ 30Hz | |
| | | 3840 x 2160 @ 50Hz | |

ADDITIONAL INFORMATION

| B0/Established Timing | B0/Standard Timing | B1/Video Mode | B1/Detail Timing |
|-----------------------|--------------------|--------------------|------------------|
| | | 3840 x 2160 @ 60Hz | |
| | | 4096 x 2160 @ 24Hz | |
| | | 4096 x 2160 @ 25Hz | |
| | | 4096 x 2160 @ 30Hz | |
| | | 4096 x 2160 @ 50Hz | |
| | | 4096 x 2160 @ 60Hz | |

Analog (VGA)

Native resolution: 1920 x 1080 @ 60Hz

| B0/Established Timing | B0/Standard Timing | B0/Descriptor Timing | B1/Detail Timing |
|-----------------------|------------------------|---------------------------------|------------------------|
| 720 x 400 @ 70Hz | 1280 x 720 @ 60Hz | 1920 x 1080 @ 60Hz [Default] | 1366 x 768 @ 60Hz |
| 640 x 480 @ 60Hz | 1280 x 800 @ 60Hz | | 1280 x 800 @ 120Hz(RB) |
| 640 x 480 @ 67Hz | 1280 x 1024 @ 60Hz | | |
| 640 x 480 @ 72Hz | | | |
| 640 x 480 @ 75Hz | 1900 x 1200 @ 60Hz(RB) | | |
| 800 x 600 @ 56Hz | 640 x 480 @ 120Hz | | |
| 800 x 600 @ 60Hz | 800 x 600 @ 120Hz | | |
| 800 x 600 @ 72Hz | 1024 x 768 @ 120Hz | | |
| 800 x 600 @ 75Hz | | | |
| 832 x 624 @ 75Hz | | | |
| 1024 x 768 @ 60Hz | | | |
| 1024 x 768 @ 70Hz | | | |
| 1024 x 768 @ 75Hz | | | |
| 1280 x 1024 @ 75Hz | | | |
| 1152 x 870 @ 75Hz | | | |

3D timing for HDMI1.4b 3D supported

| 2D Supported Frame Rate | Timing | Format |
|-------------------------|-----------------------------|---------------------|
| 59/60Hz option | 1920 x 1080p @ 23.98 / 24Hz | Frame packing |
| | 1280 x 720p @ 59.94 / 60Hz | Frame packing |
| | 1920 x 1080i @ 59.94/60Hz | Side-by-Side (Half) |
| | 1920 x 1080p @ 23.98/24Hz | Top-and-Bottom |
| | 1280x720p @ 59.94 / 60Hz | Top-and-Bottom |
| 50Hz option | 1920 x 1080p @ 23.98 / 24Hz | Frame packing |
| | 1280 x 720p @ 50Hz | Frame packing |
| | 1920 x 1080i @ 50Hz | Side-by-Side (Half) |
| | 1920 x 1080p @ 23.98/24Hz | Top-and-Bottom |
| | 1280 x 720p @ 50Hz | Top-and-Bottom |

ADDITIONAL INFORMATION

PC 3D timing

| | Timing | Format |
|------|---------------------|------------------|
| HDMI | 1920 x 1080 @ 120Hz | Frame Sequential |
| | 1280 x 800 @ 120Hz | Frame Sequential |
| | 1024 x 768 @ 120Hz | Frame Sequential |
| | 800 x 600 @ 120Hz | Frame Sequential |
| | 640 x 480 @ 120Hz | Frame Sequential |
| VGA | 1280 x 800 @ 120Hz | Frame Sequential |
| | 1024 x 768 @ 120Hz | Frame Sequential |
| | 800 x 600 @ 120Hz | Frame Sequential |
| | 640 x 480 @ 120Hz | Frame Sequential |

ADDITIONAL INFORMATION

Image size and projection distance

| Desired Image Size | | | | | | Projection Distance (C) | | | |
|--------------------|------|-------|--------|--------|--------|-------------------------|-------|------|-------|
| Diagonal | | Width | | Height | | Wide | | Tele | |
| m | inch | m | inch | m | inch | m | feet | m | feet |
| 0.91 | 36 | 0.80 | 31.38 | 0.45 | 17.65 | / | / | 1.77 | 5.80 |
| 1.02 | 40 | 0.89 | 34.86 | 0.50 | 19.61 | / | / | 1.97 | 6.45 |
| 1.27 | 50 | 1.11 | 43.58 | 0.62 | 24.51 | 1.54 | 5.05 | 2.46 | 8.06 |
| 1.52 | 60 | 1.33 | 52.29 | 0.75 | 29.42 | 1.85 | 6.06 | 2.95 | 9.67 |
| 1.78 | 70 | 1.55 | 61.01 | 0.87 | 34.32 | 2.15 | 7.07 | 3.44 | 11.29 |
| 2.03 | 80 | 1.77 | 69.73 | 1.00 | 39.22 | 2.46 | 8.08 | 3.93 | 12.90 |
| 2.29 | 90 | 1.99 | 78.44 | 1.12 | 44.12 | 2.77 | 9.09 | 4.42 | 14.51 |
| 2.54 | 100 | 2.21 | 87.16 | 1.25 | 49.03 | 3.08 | 10.10 | 4.91 | 16.12 |
| 3.05 | 120 | 2.66 | 104.59 | 1.49 | 58.83 | 3.69 | 12.11 | 5.90 | 19.35 |
| 3.81 | 150 | 3.32 | 130.74 | 1.87 | 73.54 | 4.62 | 15.14 | 7.37 | 24.19 |
| 4.57 | 180 | 3.98 | 156.88 | 2.24 | 88.25 | 5.54 | 18.17 | 8.85 | 29.02 |
| 5.08 | 200 | 4.43 | 174.32 | 2.49 | 98.05 | 6.15 | 20.19 | / | / |
| 6.35 | 250 | 5.53 | 217.89 | 3.11 | 122.57 | 7.69 | 25.24 | / | / |
| 7.62 | 300 | 6.64 | 261.47 | 3.74 | 147.08 | 9.23 | 30.29 | / | / |

| Lens Shift Range | | | | | |
|--------------------------------|-------------------------|-------------------------|--|-------------------------|------------------------|
| PJ lens Center to top of image | | | | Image Shift Range | |
| Vertical + (Max) (A) | Vertical - (Min) (B) | Vertical Shift Range | Vertical range at any Horizontal position | Horizontal + (Right) | Horizontal - (Left) |
| cm | cm | | | cm | cm |
| 51.6 | 44.8 | 6.7 | N/A | 0 | 0 |
| 57.3 | 49.8 | 7.5 | N/A | 0 | 0 |
| 71.6 | 62.3 | 9.3 | N/A | 0 | 0 |
| 85.9 | 74.7 | 11.2 | N/A | 0 | 0 |
| 100.2 | 87.2 | 13.1 | N/A | 0 | 0 |
| 114.6 | 99.6 | 14.9 | N/A | 0 | 0 |
| 128.9 | 112.1 | 16.8 | N/A | 0 | 0 |
| 143.2 | 124.5 | 18.7 | N/A | 0 | 0 |
| 171.8 | 149.4 | 22.4 | N/A | 0 | 0 |
| 214.8 | 186.8 | 28.0 | N/A | 0 | 0 |
| 257.8 | 224.1 | 33.6 | N/A | 0 | 0 |
| 286.4 | 249.1 | 37.4 | N/A | 0 | 0 |
| 358.0 | 311.3 | 46.7 | N/A | 0 | 0 |
| 429.6 | 373.6 | 56.0 | N/A | 0 | 0 |

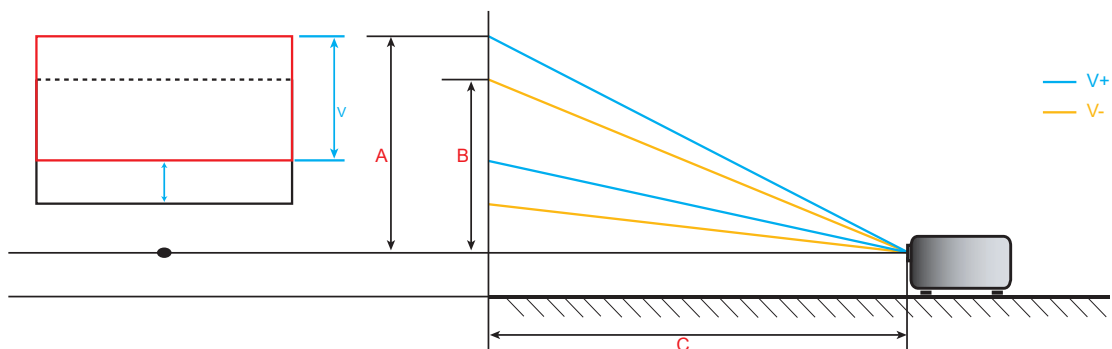

ADDITIONAL INFORMATION

Projector dimensions and ceiling mount installation

1. To prevent damage to your projector, please use the Optoma ceiling mount.
2. If you wish to use a third party ceiling mount kit, please ensure the screws used to attach a mount to the projector meet the following specifications:
 - Screw type: M6*10
 - Minimum screw length: 10mm

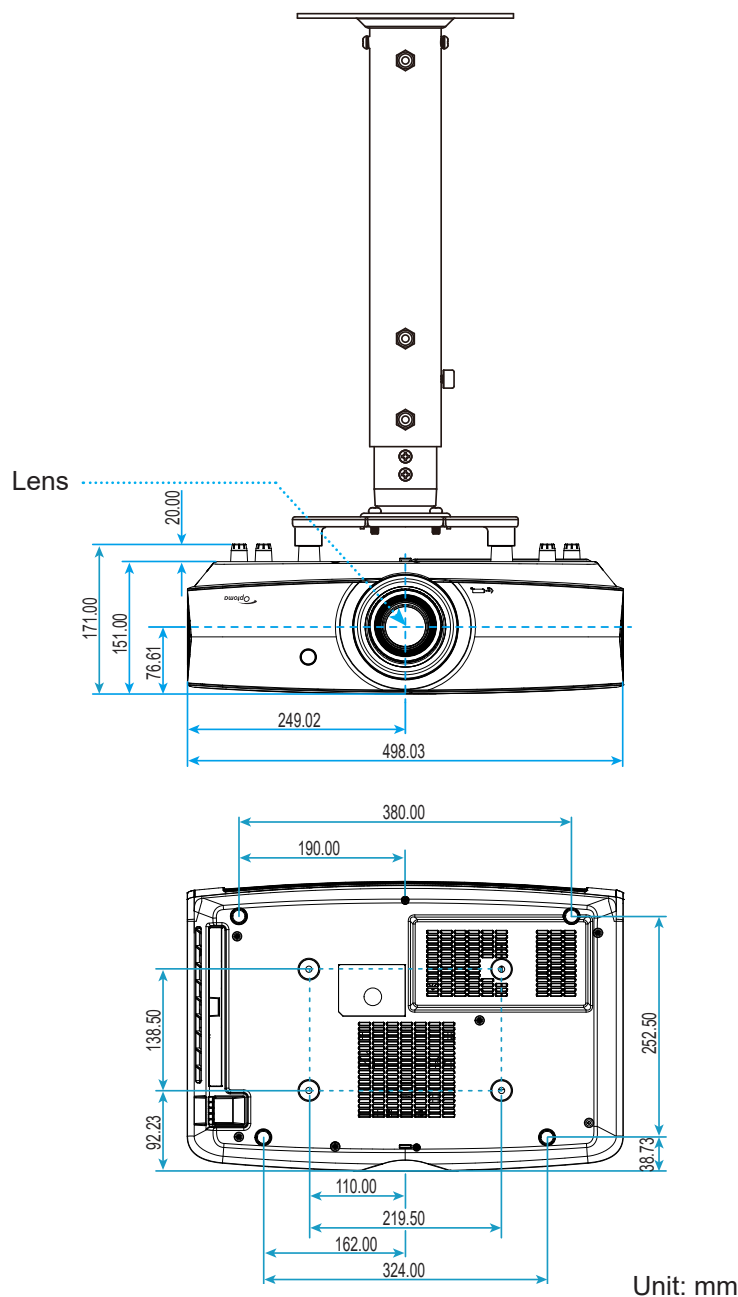

Note: Please note that damage resulting from incorrect installation will void the warranty.



Warning:

- If you buy a ceiling mount from another company, please be sure to use the correct screw size. Screw size will vary depending on the thickness of the mounting plate.
- Be sure to keep at least 10 cm gap between the ceiling and the bottom of the projector.
- Avoid installing the projector near a heat source.

ADDITIONAL INFORMATION

IR remote codes

For Data Model



| Key | Printing-key definition | Key code | | | | Repeat |
|---|-------------------------|------------|------------|--------|--------|--------|
| | | BYTE1 | BYTE2 | BYTE3 | BYTE4 | |
| | | customer 0 | customer 1 | data 0 | data 1 | |
| Power On | On | 32 | CD | 02 | #BYTE3 | F1 |
| Power Off | Off | 32 | CD | 2E | #BYTE3 | F1 |
| Geometric Correction | Geometric Correction | 32 | CD | 96 | #BYTE3 | F1 |
| F1 | F1 | 32 | CD | 26 | #BYTE3 | F1 |
| F2 | F2 | 32 | CD | 27 | #BYTE3 | F1 |
| Mode | Mode | 32 | CD | 95 | #BYTE3 | F1 |
| Four directional select keys (↑/↓/←/→) | Up arrow | 32 | CD | C6 | #BYTE3 | F1 |
| | Down arrow | 32 | CD | C7 | #BYTE3 | F1 |
| | Left arrow | 32 | CD | C8 | #BYTE3 | F1 |
| | Right arrow | 32 | CD | C9 | #BYTE3 | F1 |
| Enter | Enter | 32 | CD | C5 | #BYTE3 | F1 |
| AV Mute | AV Mute | 32 | CD | 03 | #BYTE3 | F1 |
| Information | Info. | 32 | CD | 25 | #BYTE3 | F1 |







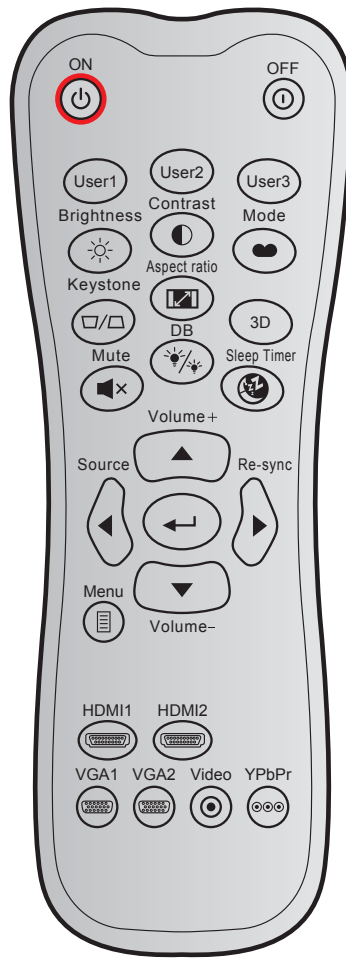



ADDITIONAL INFORMATION

| Key | Printing-key definition | Key code | | | | Repeat |
|-------------|-------------------------|------------|------------|--------|--------|--------|
| | | BYTE1 | BYTE2 | BYTE3 | BYTE4 | |
| | | customer 0 | customer 1 | data 0 | data 1 | |
| Laser * | Laser | N/A | N/A | N/A | N/A | N/A |
| Source | Source | 32 | CD | 18 | #BYTE3 | F1 |
| F3 | F3 | 32 | CD | 66 | #BYTE3 | F1 |
| Re-Sync | Re-Sync | 32 | CD | 04 | #BYTE3 | F1 |
| Volume | Volume + | 32 | CD | 09 | #BYTE3 | F1 |
| | Volume - | 32 | CD | 0C | #BYTE3 | F1 |
| D Zoom | D Zoom + | 32 | CD | 08 | #BYTE3 | F1 |
| | D Zoom - | 32 | CD | 0B | #BYTE3 | F1 |
| Menu | Menu | 32 | CD | 88 | #BYTE3 | F1 |
| Format | Format | 32 | CD | 15 | #BYTE3 | F1 |
| Freeze | Freeze | 32 | CD | 06 | #BYTE3 | F1 |
| Remote | Remote ID | 3201~ 3299 | | N/A | | |
| | Remote All | 32CD | | N/A | | |
| VGA / 1 | 1/VGA | 32 | CD | 8E | #BYTE3 | F1 |
| S-Video / 2 | 2/S-Video | 32 | CD | 1D | #BYTE3 | F1 |
| HDMI1 / 3 | 3/HDMI1 | 32 | CD | 16 | #BYTE3 | F1 |
| HDMI2 | HDMI2 | 32 | CD | 9B | #BYTE3 | F1 |
| HDBaseT / 4 | 4/HDBaseT | 32 | CD | 70 | #BYTE3 | F1 |
| Video / 5 | 5/Video | 32 | CD | 1C | #BYTE3 | F1 |
| 6 | 6 | 32 | CD | 19 | #BYTE3 | F1 |
| HDMI3 | HDMI3 | 32 | CD | 98 | #BYTE3 | F1 |
| 7 | 7 | 32 | CD | 1A | #BYTE3 | F1 |
| YPbPr / 8 | 8/YPbPr | 32 | CD | 17 | #BYTE3 | F1 |
| 9 | 9 | 32 | CD | 9F | #BYTE3 | F1 |
| 3D / 0 | 0/3D | 32 | CD | 89 | #BYTE3 | F1 |

For Home Model



| Key | | Custom code | | Key code | | Printing-key definition | Description |
|-----------------------|--|-------------|--------|----------|--------|-------------------------|--|
| | | Byte 1 | Byte 2 | Byte 3 | Byte 4 | | |
| Power on | | 32 | CD | 02 | FD | ON | Press to turn on the projector. |
| Power off | | 32 | CD | 2E | D1 | OFF | Press to turn off the projector. |
| User 1 | | 32 | CD | 36 | C9 | User1 | User defined keys. Please see page 42 to setup. |
| User 2 | | 32 | CD | 65 | 9A | User2 | |
| User 3 | | 32 | CD | 66 | 99 | User3 | |
| Brightness | | 32 | CD | 41 | BE | Brightness | Adjust the brightness of the image. |
| Contrast | | 32 | CD | 42 | BD | Contrast | Control the degree of difference between the lightest and darkest parts of the picture. |
| Display mode | | 32 | CD | 05 | FA | Mode | Select a display mode for optimized settings for different applications. Please see page 33. |
| Keystone | | 32 | CD | 07 | F8 | Keystone | No function |
| Aspect ratio | | 32 | CD | 64 | 9B | Aspect ratio | Press to change aspect ratio of a displayed image. |
| 3D | | 32 | CD | 89 | 76 | 3D | Press to manually select a 3D mode that matches your 3D content. |
| Mute | | 32 | CD | 52 | AD | Mute | Momentarily turns off / on the audio. |
| DB (Dynamic Black) | | 32 | CD | 44 | BB | DB | Automatically adjusts the picture brightness to give optimum contrast performance. |







| Key | | Custom code | | Key code | | Printing-key definition | Description |
|---------------------|---|-------------|--------|----------|--------|---|--|
| | | Byte 1 | Byte 2 | Byte 3 | Byte 4 | | |
| Sleep timer |  | 32 | CD | 63 | 9C | Sleep Timer | Sets the countdown timer interval. |
| Volume + | | 32 | CD | 11 | EE | Volume + | Adjust to increase volume. |
| Four direction keys |  | 32 | CD | 11 | EE | ▲ | Use ▲, ◀, ▶, or ▼ to select items or make adjustments to your selection. |
| | | 32 | CD | 10 | EF | ◀ | |
| | | 32 | CD | 12 | ED | ▶ | |
| | | 32 | CD | 14 | EB | ▼ | |
| Source | | 32 | CD | 10 | EF | Source | Press "Source" to select an input signal. |
| Enter key |  | 32 | CD | 0F | F0 |  | Confirm your item selection. |
| Re-sync | | 32 | CD | 12 | ED | Re-sync | Automatically synchronizes the projector to the input source. |
| Volume - | | 32 | CD | 14 | EB | Volume - | Adjust to decrease volume. |
| Menu |  | 32 | CD | 0E | F1 | Menu | Display or exit the on-screen display menus for projector. |
| HDMI 1 |  | 32 | CD | 16 | E9 | HDMI1 | Press "HDMI1" to choose source from HDMI 1 connector. |
| HDMI 2 |  | 32 | CD | 30 | CF | HDMI2 | Press "HDMI2" to choose source from HDMI 2 connector. |
| VGA 1 |  | 32 | CD | 1B | E4 | VGA1 | Press "VGA1" to choose source from VGA connector. |
| VGA 2 |  | 32 | CD | 1E | E1 | VGA2 | No function |
| Video |  | 32 | CD | 1C | E3 | Video | No function |
| YPbPr |  | 32 | CD | 17 | | YPbPr | No function |

ADDITIONAL INFORMATION

Troubleshooting

If you experience a problem with your projector, please refer to the following information. If a problem persists, please contact your local reseller or service center.

Image problems

-  *No image appears on-screen*
- Ensure all the cables and power connections are correctly and securely connected as described in the "Installation" section.
 - Ensure the pins of connectors are not crooked or broken.
 - Ensure that the "Mute" feature is not turned on.
-  *Image is out of focus*
- Turn the focus ring clockwise or counterclockwise until the image is sharp and legible. (Please see page 19).
 - Make sure the projection screen is between the required distance from the projector. (Please refer to page 56).
-  *The image is stretched when displaying 16:9 DVD title*
- When you play anamorphic DVD or 16:9 DVD, the projector will show the best image in 16: 9 format on projector side.
 - If you play the LBX format DVD title, please change the format as LBX in projector OSD.
 - If you play 4:3 format DVD title, please change the format as 4:3 in projector OSD.
 - Please setup the display format as 16:9 (wide) aspect ratio type on your DVD player.
-  *Image is too small or too large*
- Turn the zoom lever clockwise or counterclockwise to increase or decrease the projected image size. (Please see page 18).
 - Move the projector closer to or further from the screen.
 - Press "Menu" on the projector panel, go to "Display → Aspect Ratio". Try the different settings.
-  *Image has slanted sides:*
- If possible, reposition the projector so that it is centered on the screen and below the bottom of the screen.
-  *Image is reversed*
- Press "Menu" on the projector panel, go to "Setup → Projection" from the OSD and adjust the projection direction.

ADDITIONAL INFORMATION

Other problems



The projector stops responding to all controls

- If possible, turn off the projector, then unplug the power cord and wait at least 20 seconds before reconnecting power.

Remote control problems



If the remote control does not work

- Check the operating angle of the remote control is pointed within $\pm 15^\circ$ to the IR receiver on the projector.
- Make sure there are not any obstructions between the remote control and the projector. Move to within 7 m (23 ft) of the projector.
- Make sure batteries are inserted correctly.
- Replace batteries if they are exhausted.

ADDITIONAL INFORMATION

Warning indicators

When the warning indicators (see below) light up or flash, the projector will automatically shutdown:

- “Laser” LED indicator is lit red and if “Power” indicator flashes red.
- “Temp” LED indicator is lit red and if “Power” indicator flashes red. This indicates the projector has overheated. Under normal conditions, the project can be switched back on.
- “Temp” LED indicator flashes red and if “Power” indicator flashes red.

Unplug the power cord from the projector, wait for 30 seconds and try again. If the warning indicator light up or flash, please contact your nearest service center for assistance.

LED lightning messages

| Message | Power LED | | Temp LED | Laser LED |
|----------------------------------|--------------|---|--------------|--------------|
| | (Red) | (Blue) | (Red) | (Red) |
| Standby state (Input power cord) | Steady light | | | |
| Power on (Warming) | | Flashing (0.5 sec off / 0.5 sec on) | | |
| Power on and Laser lighting | | Steady light | | |
| Power off (Cooling) | | Flashing (0.5 sec off / 0.5 sec on). Back to red steady light when cooling fan turns off. | | |
| Error (Laser failure) | Flashing | | | Steady light |
| Error (Fan failure) | Flashing | | Flashing | |
| Error (Over temp.) | Flashing | | Steady light | |
| Standby State (Burn in mode) | | Flashing | | |
| Burn-in (Warming) (*) | | Flashing | | |
| Burn-in (Cooling) (*) | | Flashing | | |
| Burn in (Laser lighting) (*) | | Flashing (3 sec on / 1 sec off) | | |
| Burn in (Laser off) (*) | | Flashing (1 sec on / 3 sec off) | | |

Note:

- *(*)If power is less than 0.5W and the power LED is red, change the power LED to flashing red.*
 - Turn all LEDs off after the OSD menu disappears.*
 - Power LED on: No signal; OSD disappears.*
 - Power LED off: Signal is detected; OSD disappears.*

ADDITIONAL INFORMATION

- Power off:

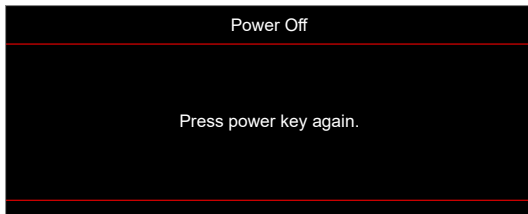

- Temperature warning:

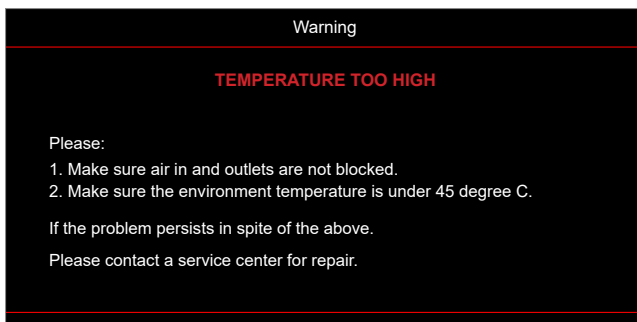

ADDITIONAL INFORMATION

Specifications

| Optical | Description |
|-----------------------|--|
| Maximum resolution | 4K UHD |
| Native resolution | 2716 x 1528 |
| Lens | Manual zoom and manual focus adjustment |
| Image size (diagonal) | 26.45"~302.2" (focus range, optimized @ wide 60" image size) |
| Projection distance | 1.3m ~ 9.3m (focus range, optimized @ wide 1.846m) |
| Color temperature | Standard D65: (0.313, 0.329) |

| Electrical | Description |
|--------------------|---|
| Inputs | <ul style="list-style-type: none">• HDMI 1.4b• HDMI V2.0 HDCP2.2 / MHL V2.2• VGA In (supports YpbPr)• Audio In 3.5mm• RS232C male (9-pin D-SUB)• RJ-45 (supports web control)• USB type A |
| Outputs | <ul style="list-style-type: none">• Audio Out 3.5mm• SPDIF Out• 12V Trigger (3.5mm jack) |
| Control | USB type A for service |
| Color reproduction | 1073.4 Million color |
| Scan rate | <ul style="list-style-type: none">• Horizontal scan rate: 31.000~135.000KHz• Vertical scan rate: 24~120Hz |
| Built-in speaker | Yes, 2x 5W |
| Power requirement | 100 - 240V ±10%, AC 50/60Hz |
| Input current | 4.4A |

| Mechanical | Description |
|--------------------------|--|
| Installation orientation | Front, Rear, Ceiling-top, Rear-top |
| Dimensions | 498.1mm (W) x 331.1mm (D) x 154mm (H) (without feet) |
| Weight | Less than 10kg |
| Environmental conditions | Operating in 5~40°C , 10% to 85% humidity (non-condensing) |

Note: All specifications are subject to change without notice.



ADDITIONAL INFORMATION

Optoma global offices

For service or support, please contact your local office.



USA

47697 Westinghouse Drive,
Fremont, CA 94539, USA
www.optomausa.com

 888-289-6786
 510-897-8601
 services@optoma.com



Canada

47697 Westinghouse Drive,
Fremont, CA 94539, USA
www.optomausa.com

 888-289-6786
 510-897-8601
 services@optoma.com



Latin America

47697 Westinghouse Drive,
Fremont, CA 94539, USA
www.optomausa.com

 888-289-6786
 510-897-8601
 services@optoma.com



Europe

Unit 1, Network 41, Bourne End Mills
Hemel Hempstead, Herts,
HP1 2UJ, United Kingdom
www.optoma.eu
Service Tel : +44 (0)1923 691865

 +44 (0) 1923 691 800
 +44 (0) 1923 691 888
 service@tsc-europe.com



Benelux BV

Randstad 22-123
1316 BW Almere
The Netherlands
www.optoma.nl

 +31 (0) 36 820 0252
 +31 (0) 36 548 9052



France

Bâtiment E
81-83 avenue Edouard Vaillant
92100 Boulogne Billancourt, France

 +33 1 41 46 12 20
 +33 1 41 46 94 35
 savoptoma@optoma.fr



Spain

C/ José Hierro,36 Of. 1C
28522 Rivas VaciaMadrid,
Spain

 +34 91 499 06 06
 +34 91 670 08 32



Deutschland

Wiesenstrasse 21 W
D40549 Düsseldorf,
Germany

 +49 (0) 211 506 6670
 +49 (0) 211 506 66799
 info@optoma.de

Scandinavia



Lerpeveien 25
3040 Drammen
Norway

 +47 32 98 89 90
 +47 32 98 89 99
 info@optoma.no

PO.BOX 9515
3038 Drammen
Norway

Korea

WOOMI TECH.CO.,LTD.
4F, Minu Bldg.33-14, Kangnam-Ku,
Seoul,135-815, KOREA
korea.optoma.com

 +82+2+34430004
 +82+2+34430005



Japan

東京都足立区綾瀬3-25-18
株式会社オーエス
コンタクトセンター:0120-380-495

 info@os-worldwide.com
www.os-worldwide.com



Taiwan

12F., No.213, Sec. 3, Beixin Rd.,
Xindian Dist., New Taipei City 231,
Taiwan, R.O.C.
www.optoma.com.tw

 +886-2-8911-8600
 +886-2-8911-6550
 services@optoma.com.tw
asia.optoma.com



Hong Kong

Unit A, 27/F Dragon Centre,
79 Wing Hong Street,
Cheung Sha Wan,
Kowloon, Hong Kong

 +852-2396-8968
 +852-2370-1222
www.optoma.com.hk

China

5F, No. 1205, Kaixuan Rd.,
Changning District
Shanghai, 200052, China

 +86-21-62947376
 +86-21-62947375
www.optoma.com.cn



P/N:36.7F701G001-A