







A	Dowel		2pcs
B	Screw		14pcs
C	Anchor		2pcs

1		3pcs
2		2pcs
3		2pcs



STEP 1

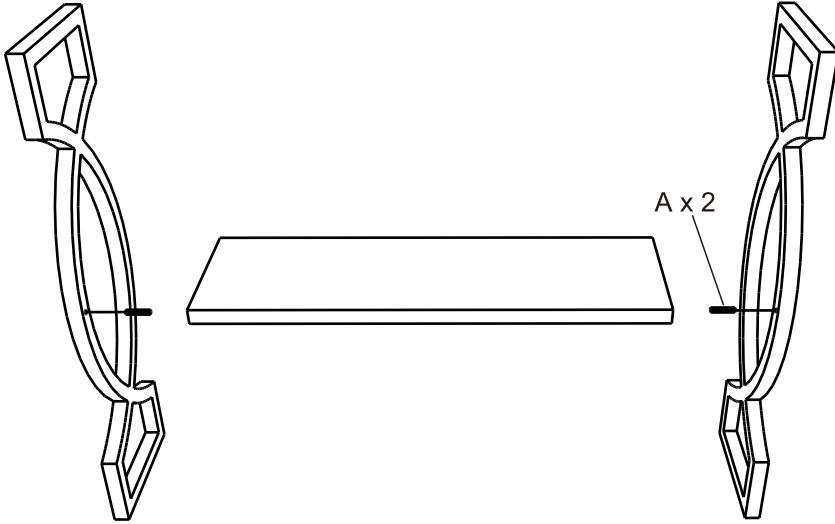
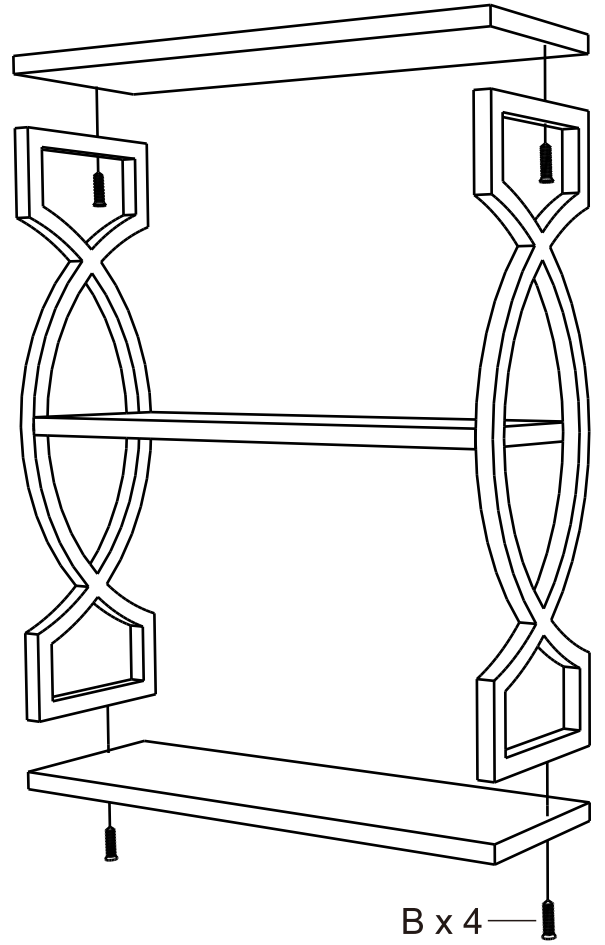

STEP 2

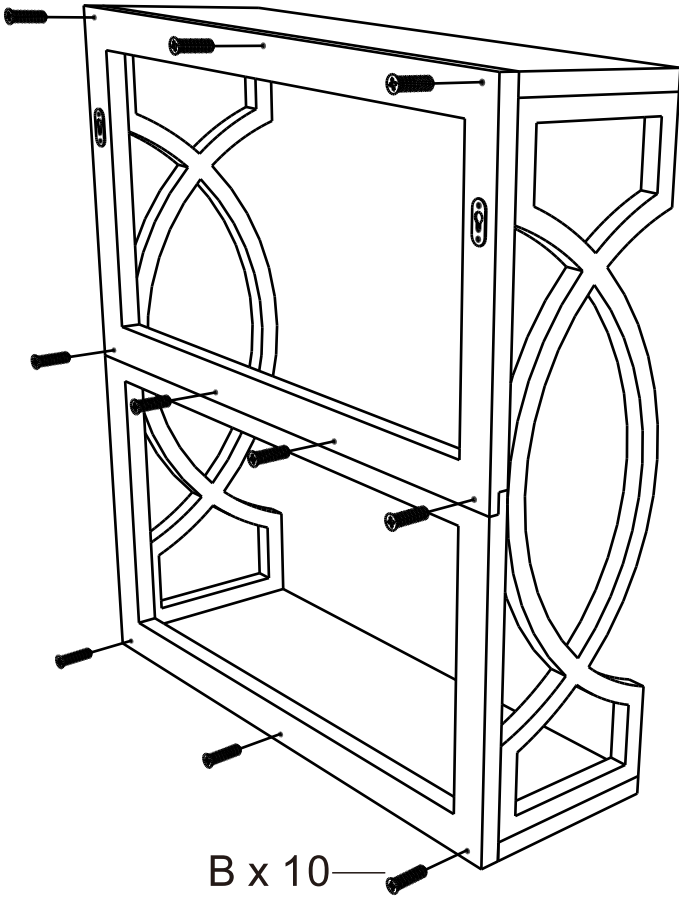

STEP 3